

ISOLAB

Laborgeräte GmbH



English Edition



ISOLAB

Laborgeräte GmbH

*one stop shopping
for laboratories*

- 
- glasswares* ✓
 - consumables* ✓
 - equipments* ✓
 - instruments* ✓
 - chemicals* ✓

2020 - 2022



*Dear customer,
We are proud to present our
new, colourful and cheerful
catalogue to your taste.
Main “highlights” of our new catalogue are;*

*We added hundreds of
new products that were carefully
selected to ease your daily work.*



*Products are categorised with
different section colors according
to their areas of utilization.*

*New designed product and
catalogue number indexes offer
easy and fast access to products.*



*We are now offering a wide range
of chemicals and reagents with a
perfect price & quality correlation.*

highlights
our goals, mission and vision

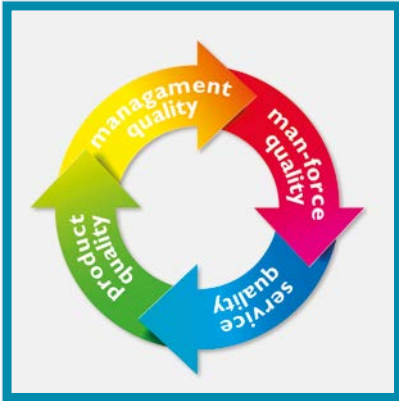

For us, the only important factor is quality. Our product quality, service quality, man-force quality, and management quality will never change.



Our compass always directs us to perfection. German sensibility and perfectionism are two main components of our entire business life.



We deny the word "impossible". We have no place in our vocabulary such as "impossible". In contrast, we have opportunity, solution, flexibility.



We consider our customers as the sole judge in this game that we have been playing with enthusiasm. Customer satisfaction is our only criteria.



We always wanted the word "trust" to gleam next to our name. And it is actually what happened. Our belief is that everything starts with trust.



It is our sincere belief that we were all born from the same mother. We are always respectful to the environment and the world we live in.



Everyday we embrace new ideas. Each morning we spend the first hours for implementing new ideas to our business.

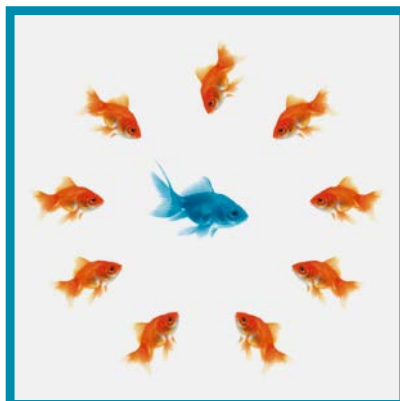

We differentiate ourselves from the ordinary. We always try to create new ideas and strategies for being a pioneer in our field of activity.



For many years now, we have been working for science extending beyond boundaries. We have been successfully exporting to 110 countries in the world.

product groups classified by colors

volumetric measurement & liquid handling (001 - 024)

laboratory consumables & labware (025 - 080)

distillation & filtration & separation & sample preparation (081 - 114)

cleaning & safety & protection & sterilization (115 - 136)

density & temperature & time & pH & weight measurement (137 - 154)

stirring & mixing & shaking & heating & cooling (155 - 164)

chromatography & spectroscopy (165 - 178)

life sciences & microscopy & microbiology (179 - 210)

how to use QR code



Based on the principles of innovative approach we, as ISOLAB Family, are dedicated to giving you the best user experience and technical support when you need.

On our brand new product catalogue, we launched a very useful feature, which allows you to explore ISOLAB World with a 360° view!

Now you can start to scan product QR codes on relevant product pages and take a 360° look at ISOLAB products, for a 360° scene of quality.



Scan barcodes on our catalogue by your smartphone easily in all platforms or just click in the digital catalogue.

SCAN

Please scan barcodes in the catalogue by using QR code scanner on your smartphone.

CLICK

Please kindly click in the link shown in your QR code scanner or click directly in your digital catalogue.

WATCH

You can see the details of the products on youtube.



Please subscribe our youtube channel



Scan here for further details about ISOLAB





ISOLAB
Laborgeräte GmbH



volumetric measurement & liquid handling

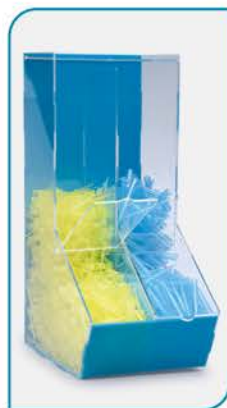
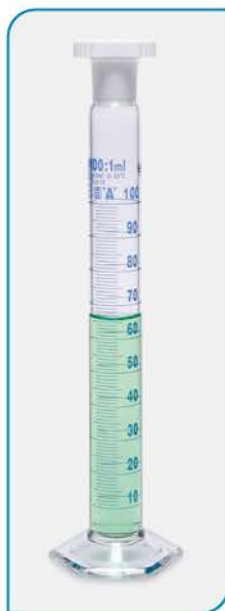
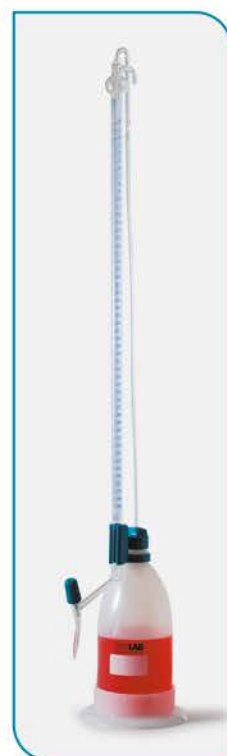

volumetric measurement & liquid handling

blank production



State of the art automatic welding and attaching machines are used for connecting the glass parts to each other.

ISOLAB is one of the few manufacturers that produces its own blank products.

Glass tubes are blown by highly skilled blowers to ensure the uniform wall thickness, exact shape and dimensions according to DIN standards.

After rigorous controls, all blanks are sent to tunnel furnaces where the stress on the blanks is eliminated under controlled heating and cooling process.

This process ensures the optimum mechanical stability and inhibits the effect of temperature fluctuations.



Glass tubes are blown by highly skilled blowers to ensure the uniform wall thickness, exact dimensions according to DIN standards.

joint production

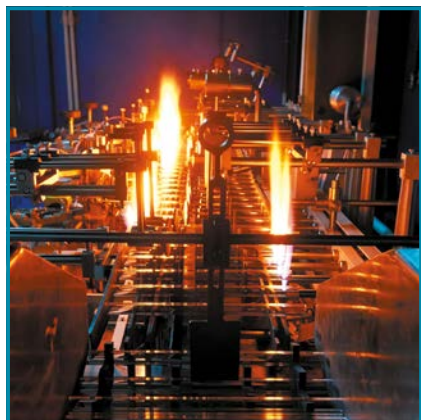

All joints are manufactured by automatic forming machines for consistent quality and guaranteed uniformity.

ISOLAB manufactures all joints with automatic machines with guaranteed uniformity.

During the grinding process, only diamond tools are used to ensure perfect results.

The taper of the joints are tested with precise taper angle control machine to ensure the taper quality.

This process ensures ending up with accurately tapered, smoothly finished, absolutely leak-proof and interchangeable ground joints.

The tightness also tested with vacuum test machines.



Grinding steps are performed by diamond reamers assuring best results with highest precision.

calibrated tubing production



Glass tubings are slowly and gradually heated up to half-melting level. Then they are shrunk around steel rods with precise diameter.

Most of the burette manufacturers use ordinary tubings which are more tolerant in terms of wall thickness and inside diameter.

ISOLAB burette tubings are manufactured by using vacuum technology to maintain inside diameter of the burette tubings uniform all over their length.

First tubings are slowly and gradually heated up to half-melting level.

Then they are shrunk around steel rods with precise diameter under vacuum condition for uniform wall thickness and diameter.



Burette tubings are manufactured by using vacuum technology to maintain diameter of the burette tubings uniform all over their length.

volumetric measurement & liquid handling

printing process

ISOLAB uses the most advanced printing machines for achieving the highest printing quality.

These machines guarantee high contrast and sharp printing providing precise reading.

All used screen stencils are stretchable.

The stretchable screen stencils easily stretched to match the calibration marks so that the volume precision is maintained at all volume levels.

Specially formulated blue, white or amber colored enamels are used during printing process.

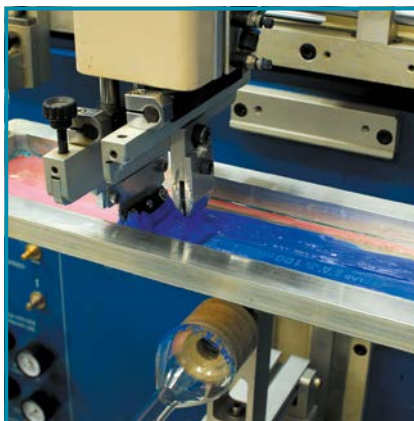

Only high contrasted and fine printing allows precise reading of scaled products such as cylinders, burettes, pipettes etc.

ISOLAB DIN 'A' In 20°C 2000 ml : 1450 NS 2932-9090 3.3 DE-M 19

According to DIN standards the information listed hereunder is required to be printed on the bodies of products.

- Brand name
- Nominal capacity
- Class degree
- Calibration temperature
- Matching standards
- Possible error limits
- Batch numbers
- Production date
- Warnings, etc

annealing process

Furnace process is the last step to reach a perfect product.

In order to achieve, stress-free products with highest level of printing quality precise controlled gradual heating and cooling is essential.

At **ISOLAB**, all heating and annealing steps are carried with state-of-art temperature controlled tunnel furnaces.

For these reasons all **ISOLAB** glassware are stress-free, mechanically strong and ever lasting printed.

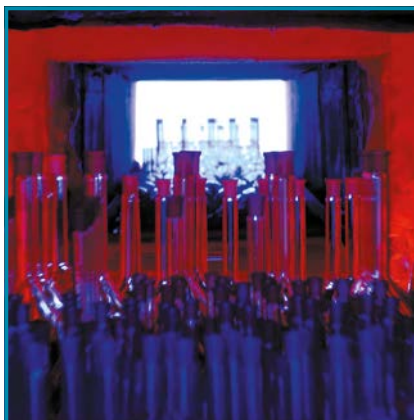

In order to achieve the best results, the furnace has a precise temperature control all-over the thermal heating zone.



Furnace is entirely controlled by electronic panel for guaranteed temperature control at all steps.

packing process

ISOLAB is perfectly aware that the products used in laboratory should be very clean and excellently packed.

All glassware are washed in industrial scale ultrasonic cleaning machines for removing all the dirt and left over particles.

Our staff responsible for the final quality control of the packaging is extremely qualified and well experienced.

High quality packing materials are used to ensure break-free delivery of the products.



Modern industrial scale ultrasonic cleaning machines guarantee perfect removal of all remaining dirt and particles.



The final step of the packing is also the final step of quality control process.

volumetric measurement & liquid handling

calibration

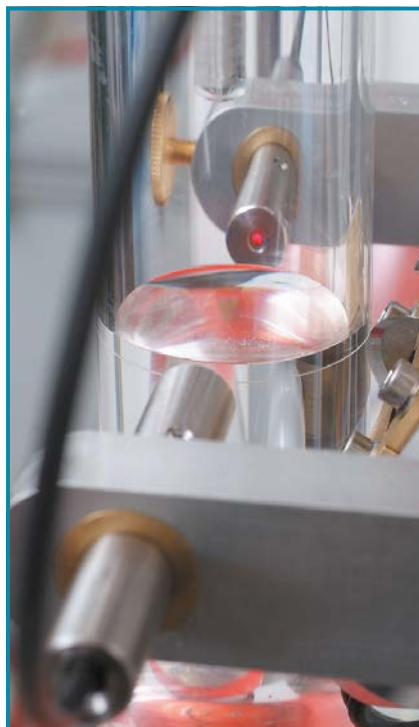

Meniscus is determined automatically at the exact lowest level by a laser beam.

Manual calibration done by an operator carries high risk of mistakes and is not reliable.

All calibration steps are carried out with fully automatic robots.

These robotic machines guarantee the highest level of precision and accuracy.

Although during the calibration process the room temperature environment is kept stable at 20°C any slight change in the room temperature is automatically compensated by the machines.

Meniscus is automatically determined at the exact lowest level by a laser beam.

Application of the meniscus ring line is done by stretching the glass surface for longer persistence with the help of a diamond tool. Later the stretched ring line is stained with either blue or white enamel paint for easy observation of meniscus line.



Filling the blank products with water is done automatically by the calibration machines.

quality control



Steps such as filling the water, finding the meniscus line and controlling the volume are done automatically.

Manual quality control of volumetric products is also very complex and time consuming. Also, manual quality control done by an operator carries high risk of mistakes and is not reliable.

In order to avoid above mentioned risks and to achieve the best reliable results quality control steps are carried out with fully automatic robots which are only used by very few selected manufacturers.

Quality control robot is featured with a high resolution camera and image processing system for the most precise meniscus level control.

Steps such as filling the water, finding the meniscus line and controlling the volume are done automatically.

The balances and the electronic calibrated thermometers are in-line connected to the system for online data transfer.

The operator simply mounts the volumetric glass to the quality control robot and waits for the precision guaranteed outcome.



The operator simply mounts the volumetric glass to the quality control robot and waits for the precision guaranteed outcome.

volumetric measurement & liquid handling conformity

“Conformity” is the compliance of the product with the exact and legal standards defined by German Federal Weights and Measures (Eichordnung) Regulation.

The “conformity testing and certification” is described in detail on **DIN 12600** standard.

According to German law of metrology, only listed accredited manufacturers such as **ISOLAB** with a guaranteed quality assurance are allowed to certify the conformity by printing the conformity logo (**DE-M**) on self manufactured volumetric products.

The manufacturer’s logo should also be printed along with the conformity logo. We are very proud of having this logo printed on our related products as a guarantee of conformity according to **DIN 12600** standard starting from day one.

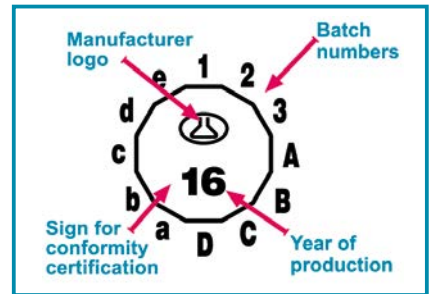

batch certification

“Batch certificate” shows the determined mean value of the controlled standard deviation and tolerance of volumetric products batch to batch.

After the production of each batch, the mandatory minimum quantity is randomly tested and certified according to **DIN 12600** standard.

The “batch certificate” comprises the date of production, mean value, standard deviation, permitted tolerance and other information.

By tracking the batch number user can reach the related batch certificate.

Batch numbers and related certificates can be downloaded from our **ISOLAB** web site. Users can print the “batch certificate” online with the following steps:

- For downloading the certificate please enter www.isolab.de web site, and
- select “downloads/support” from the menu
- select the product code number from “obtain certificates” section
- select the batch number printed on the body
- certificate page comes automatically
- print the page by selecting “printer version” on the left corner.



quality certification

An “individual quality certificate” can also be issued for volumetric products.

“Quality certificate” shows the final and ultime tested factors of the volumetric products.

Such a certificate is always well accepted worldwide since it should be prepared by a worldwide accredited test laboratory.

The selected product is individually tested in the most precise way and controlled as defined by German Federal Weights and Measures (Eichordnung) Regulation and according to **DIN 12600** standard.

Individually prepared and printed quality certificate comprising the date of production, mean value, standard deviation, permitted tolerance and other informations.



volumetric measurement & liquid handling

classification

All volumetric products are always calibrated as **to contain (In)** or **to deliver (Ex)**.

They are classified in three groups; **Class "B"** or **Class "A"** or **"AS"**.

Class "A" and **"AS"** carry exactly the same error and tolerance limits.

The difference is in their "delivery" and "waiting times". "S" means quick (swift) delivery.

The classification as **"A"** or **"B"** indicates the degree of accuracy of related parameters.

Class **"A"** or **"AS"** volumetric products carry highest level of accuracy and specially well accepted by laboratories looking for quality.

The error limits, accuracy and variations are always in accordance with relevant **ISO** or **DIN** standard limits.

delivery time

Delivery time is the time needed to deliver the liquid from the starting level to the final level.

For burettes and pipettes final level is generally the tip of the product.

waiting time

The waiting time starts after complete transfer is finalised.

After the transfer of the liquid usually liquid continues to flow down from the burette or pipette wall.

For accurate volume measurement attention must be paid to the waiting time.

Specially with pipettes the residual drop accumulated at the tip should be considered.

meniscus line

A simple definition of meniscus is the curve on the surface of the liquid.

According to **DIN**, **ISO** and most other standards volume should be read at the lowest liquid level.

The lowest level of the meniscus has to touch the upper edge of the graduation mark.

On the volumetric glassware the form of the meniscus is concave.

For the exact and most precise results, the eye of the observer must be exactly at the same level of meniscus line.

To have a better, faster and more accurate reading and measurement, a black strip should be held at the back side, just below of the graduation mark and meniscus line.

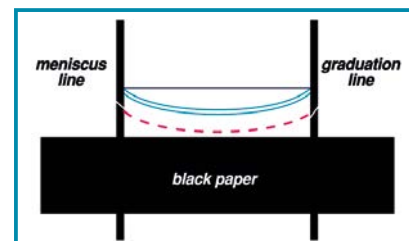

schellbach stripe

The schellbach stripe is a narrow blue band which takes place at the center of a wider white band on the burette tube background.

Mostly printed at the backside of the burette tube for easier observation of meniscus line.

The penetrated light fraction two arrow head points that appear at the meniscus line.

Exact meniscus line is exactly where two arrow heads touch each other.

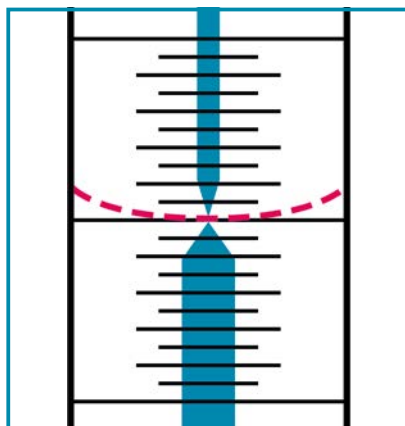

how to use volumetric flasks

- Volumetric flasks are mainly used for preparation of highly accurate solutions.
- First add the exact weight of the product inside the flask. Fill the flask about half the volume and mix the content.
- Then fill again until the level reaches a bit lower than calibration ring mark.
- Adjust the temperature of flask and the content to 20°C.
- Add a little more liquid so that the meniscus will be exactly at the same level of the ring mark.
- Pay attention to read the meniscus at the eye level also not to wet the inner neck wall above the ring mark.



how to use measuring cylinders

- Cylinders are mainly used for the exact measurement of liquid volumes.
- First fill the cylinder with liquid and wait until the residual liquid on the wall will filter down.
- Then read the volume level from the cylinders volume graduation chart.
- Pay attention to read the volume level at the eye level. Do not wet the inner neck wall above the calibration mark.



how to use mixing cylinders

- Mixing cylinders are mainly used for the exact measurement of liquid volumes.
- First fill the cylinder with liquid and wait until the residual liquid on the wall to filter down.
- Then read the volume level from the cylinders volume graduation chart.
- Later add the precise weight of the substance and dissolve it by shaking the cylinder.



how to use burettes

- Fill the burette a bit higher than the "0" level.
- To activate the stopcock, drain the solution but never below the "0" mark.
- Pay attention there will be no air bubbles left in the burette.
- Fill more solution above 10 mm of the "0" mark. Do not wet the burette wall above the liquid level.
- By focusing the meniscus at eye level drain the solution to the exact "0" mark.
- Wipe off the drops at the stopcock tip and slowly start the titration. When color changes stop the titration and wait for the 30 seconds.
- Wipe off the remaining drop since this is also the part of the measured volume.



how to use pipettes

- Fill the liquid max 5 mm above the volume mark. Wipe off the outer surface of the pipette.
- Hold the pipette at eye level and place the tip to the wall of a beaker with a slight angle.
- Discharge the excess volume until the meniscus reaches the calibration mark.
- When the level of the liquid reaches to the tip wait according to waiting time.
- When the waiting time is over, wipe the tip gently pulling upwards on the beaker wall and transfer the liquid.
- If there is still any residual liquid left in the tip, never blow out.



how to use density bottles

- Carefully weigh the empty and well dried density bottle.
- Fill the bottle up to 2/3 of the neck level while avoiding air bubbles.
- Adjust the bottle temperature to 20°C in a thermostatic bath. Insert the stopper of the bottle carefully. The capillary of the stopper will discharge the liquid.
- Dry the body of the bottle and the stopper carefully by wiping with a tissue paper. Pay attention not to remove any liquid from the capillary tube.
- The liquid inside of the bottle should exactly be at the same level with the upper end of the capillary tube.
- Final step is weighing the filled density bottle and calculating the density.



volumetric measurement & liquid handling

VOLUMETRIC FLASKS - "glass" - "class A" "conformity certified"



➤ Manufactured from heat resistant borosilicate 3.3 glass according to DIN EN ISO 1042 standard. Calibrated by automatic robots according to DIN/ISO Class "A" standard.

➤ Conformity mark ("DE-M") and batch number printed on the body surface. Batch certificate can be downloaded from website.

➤ Blue and white colored diamond grinded meniscus ring mark offers longer persistence. Inscriptions on the flask bodies are printed with long lasting enamel color.

➤ Flasks are supplied with a leak-proof P.E stopper which ensures perfect closure.

clear flasks	amber flasks	volume	neck NS size	pack quantity
013.01.005	014.01.005	5 ml	NS 10/19	2 pieces
013.01.010	014.01.010	10 ml	NS 10/19	2 pieces
013.01.020	014.01.020	20 ml	NS 10/19	2 pieces
013.01.025	014.01.025	25 ml	NS 10/19	2 pieces
013.01.026	014.01.026	25 ml	NS 12/21	2 pieces
013.01.050	014.01.050	50 ml	NS 12/21	2 pieces
013.01.051	014.01.051	50 ml	NS 14/23	2 pieces
013.01.100	014.01.100	100 ml	NS 12/21	2 pieces
013.01.101	014.01.101	100 ml	NS 14/23	2 pieces
013.01.150		150 ml	NS 14/23	2 pieces
013.01.200	014.01.200	200 ml	NS 14/23	2 pieces
013.01.250	014.01.250	250 ml	NS 14/23	2 pieces
013.01.300		300 ml	NS 14/23	2 pieces
013.01.400		400 ml	NS 19/26	2 pieces
013.01.500	014.01.500	500 ml	NS 19/26	2 pieces
013.01.901	014.01.901	1000 ml	NS 24/29	2 pieces
013.01.902	014.01.902	2000 ml	NS 29/32	2 pieces
013.01.905		5000 ml	NS 34/35	1 piece
013.01.910		10000 ml	NS 45/40	1 piece

150 ml, 300 ml, 400 ml and 10000 ml volumetric flasks are in addition to DIN range.

VOLUMETRIC FLASKS - "glass" - "class A" "conformity certified" - "COATED"



➤ When handling dangerous and/or valuable solutions coated volumetric flasks are highly recommended.

➤ Bodies of these flasks are coated with a special formulated coating which reduces the impacts and also minimize the possible risks in case of breakage. Coating covers the body like a protective glove and holds the broken parts unscattered.

➤ The coating is highly transparent and can resist up to 135°C with maximum period of 30 minutes. Coated flasks should not be exposed directly to open flame.

➤ All other technical specifications are identical with standard body volumetric flasks.

coated clear flasks	coated amber flasks	volume	neck NS size	pack quantity
013.01.005C	014.01.005C	5 ml	10/19	2 pieces
013.01.010C	014.01.010C	10 ml	10/19	2 pieces
013.01.020C	014.01.020C	20 ml	10/19	2 pieces
013.01.025C	014.01.025C	25 ml	10/19	2 pieces
013.01.026C	014.01.026C	25 ml	12/21	2 pieces
013.01.050C	014.01.050C	50 ml	12/21	2 pieces
013.01.051C	014.01.051C	50 ml	14/23	2 pieces
013.01.100C	014.01.100C	100 ml	12/21	2 pieces
013.01.101C	014.01.101C	100 ml	14/23	2 pieces
013.01.150C		150 ml	14/23	2 pieces
013.01.200C	014.01.200C	200 ml	14/23	2 pieces
013.01.250C	014.01.250C	250 ml	14/23	2 pieces
013.01.300C		300 ml	14/23	2 pieces
013.01.400C		400 ml	19/26	2 pieces
013.01.500C	014.01.500C	500 ml	19/26	2 pieces
013.01.901C	014.01.901C	1000 ml	24/29	2 pieces
013.01.902C	014.01.902C	2000 ml	29/32	2 pieces

150 ml, 300 ml, 400 ml and 10000 ml volumetric flasks are in addition to DIN range.

VOLUMETRIC FLASKS - "glass" - "class A" - "conformity certified" - "trapezoidal"

- Manufactured from heat resistant, borosilicate glass 3.3 according to DIN EN ISO 1042 standard.
- Trapezoidal body form offers much higher stability and avoids fall over risk.
- Calibrated according to DIN/ISO Class "A" standard. Featured with a ("DE-M") conformity mark according to German Federal Weights and Measures Regulations.
- Individual calibration carried out by automatic robots eliminate possible deviations from nominal values.
- Conformity mark and batch number printed on the body surface. Batch certificate can be downloaded from website.
- Diamond grinded meniscus ring mark offers longer persistence and enables easy observation of meniscus level.
- Inscriptions on the flask bodies are printed with long lasting enamel color.
- All volumetric flasks are supplied with a leak-proof P.E stopper which ensures perfect closure.

Small size flasks with standard body shape can fall over very easily due to their smaller center of gravity.

Compared to other standard volumetric flasks of the same volume, trapezoidal flasks have at least twice base area.

For this reason trapezoidal flasks are much more stable than standard flasks.

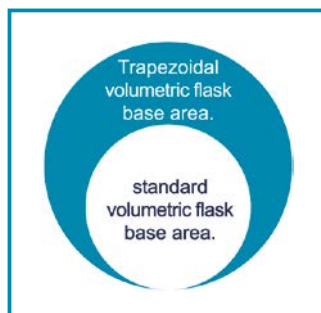

clear flasks	amber flasks	volume	neck NS size	pack quantity
013.13.001	013.15.001	1 ml	07/16	2 pieces
013.13.002	013.15.002	2 ml	07/16	2 pieces
013.13.003	013.15.003	3 ml	07/16	2 pieces
013.13.004	013.15.004	4 ml	07/16	2 pieces
013.13.005	013.15.005	5 ml	07/16	2 pieces
013.13.010	013.15.010	10 ml	10/19	2 pieces
013.13.020	013.15.020	20 ml	10/19	2 pieces
013.13.025	013.15.025	25 ml	10/19	2 pieces
013.13.050	013.15.050	50 ml	12/21	2 pieces

VOLUMETRIC FLASKS - "PP" - "class B"

- Manufactured according to DIN EN ISO 1042 standard from clear polypropylene. Resistant to most acids, bases and many commonly used solvents.
- Calibrated according to DIN/ISO Class "B" standard.
- Clear flasks are manufactured from very clear polypropylene resulting high transparency and clear indication of meniscus line.
- Amber flasks are manufactured from special formulated polypropylene preventing UV light penetration into the flask yet still offering high transparency.
- All volumetric flasks are supplied with a leak-proof P.E stopper which ensures perfect closure.
- For consistent accuracy should not be used with liquids over 60°C or kept under direct sunlight for long periods.

clear flasks	amber flasks	volume	neck NS size	pack quantity
014.03.025	014.13.025	25 ml	10/19	1 piece
014.03.050	014.13.050	50 ml	12/21	1 piece
014.03.100	014.13.100	100 ml	14/23	1 piece
014.03.250	014.13.250	250 ml	14/23	1 piece
014.03.500	014.13.500	500 ml	19/26	1 piece
014.03.901	014.13.901	1000 ml	24/29	1 piece

volumetric measurement & liquid handling

CYLINDERS - "glass" - "class A" - "conformity certified"



► Manufactured from heat resistant borosilicate 3.3 glass according to DIN EN ISO 4788 standard. Calibrated by automatic robots according to DIN/ISO Class "A" standard.

► Conformity mark ("DE-M") and batch number printed on the body surface. Batch certificate can be downloaded from website.

► Inscriptions on the flask bodies are printed with long lasting enamel color.

► Flawless spout design assures pouring without any drips.

► Hexagonal base with strengthened knobs ensures increased stability.

► Mixing cylinders are supplied with a P.E stopper.

measuring cylinders	mixing cylinders	volume	pack quantity
015.01.005		5 ml	2 pieces
015.01.010	016.01.010	10 ml	2 pieces
015.01.025	016.01.025	25 ml	2 pieces
015.01.050	016.01.050	50 ml	2 pieces
015.01.100	016.01.100	100 ml	2 pieces
015.01.250	016.01.250	250 ml	2 pieces
015.01.500	016.01.500	500 ml	2 pieces
015.01.901		1000 ml	2 pieces
	016.01.901	1000 ml	1 piece
015.01.902		2000 ml	1 piece

CYLINDERS "class B" - "P.P base"



► Manufactured from heat resistant, durable borosilicate glass according to DIN/ISO Class "B" standard.

► These cylinders are supplied with an interchangeable polypropylene base.

► Thick and durable polypropylene base reduces the risk of breakage during use and cleaning.

► Base perfectly fits the cylinder body and can easily be dismantled.

► Flawless spout design assures pouring without any drips.

► Inscriptions on the cylinder body are printed with white enamel.

catalogue number	volume	pack quantity
016.07.010	10 ml	2 pieces
016.07.025	25 ml	2 pieces
016.07.050	50 ml	2 pieces
016.07.100	100 ml	2 pieces
016.07.250	250 ml	2 pieces
016.07.500	500 ml	2 pieces
016.07.901	1000 ml	2 pieces

CYLINDERS - "polypropylene" - "class B"



► Manufactured according to DIN/ISO Class "B" standard from polypropylene.

► Featured with excellent transparency, high chemical and remarkable heat resistance.

► Calibrated according to DIN/ISO Class "B" standard.

► Flawless spout design assures pouring without drips.

► Thick hexagonal base with strengthened knobs ensures increased stability.

► For consistent accuracy, should not be used with liquids over 60°C or kept under direct sunlight for long periods.

► Inscriptions and nominal values are either in embossed scale or in printed blue scale.

embossed scale	printed scale	volume	pack quantity
016.05.010	016.06.010	10 ml	1 piece
016.05.025	016.06.025	25 ml	1 piece
016.05.050	016.06.050	50 ml	1 piece
016.05.100	016.06.100	100 ml	1 piece
016.05.250	016.06.250	250 ml	1 piece
016.05.500	016.06.500	500 ml	1 piece
016.05.901	016.06.901	1000 ml	1 piece

BURETTES - “straight” - “class AS” - “conformity certified”



► Manufactured from pre-vacuum calibrated borosilicate 3.3 tubing according to ISO 385 standard. Calibrated according to DIN/ISO Class “AS” standard.

► Conformity mark (“DE-M”) and batch number printed on the body surface. Batch certificate can be downloaded from website.

► Supplied with an interchangeable PTFE stopcock with identical keys which does not need “matching the pairs” during cleaning.

► Inscriptions and nominal values are printed with long lasting enamel color.

► Schellbach stripe featured with a narrow blue band which is at the center of the larger white band offers easier and accurate observation of the meniscus line.

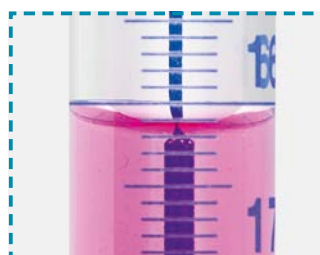

The schellbach stripe has a narrow blue band which is at the center of the larger white band.

The light fraction creates two arrow head points which appear at the meniscus line level.

Meniscus reading point is exactly where these two arrow heads meet each other.

clear burettes W/O schellbach	clear burettes with schellbach	amber burettes W/O schellbach	volume	pack quantity
017.02.010	017.01.010	018.01.010	10 ml	1 piece
017.02.025	017.01.025	018.01.025	25 ml	1 piece
017.02.050	017.01.050	018.01.050	50 ml	1 piece

AUTOMATIC BURETTES - “class AS” - “conformity certified”



► Manufactured from pre-vacuum calibrated borosilicate 3.3 tubing according to ISO 385 standard. Calibrated according to DIN/ISO Class “AS” standard.

► Conformity mark (“DE-M”) and batch number printed on the body surface. Batch certificate can be downloaded from website.

► Featured with an intermediate PTFE stopcock and with a PTFE “needle” valve stopcocks.

► Clear burettes are featured with a schellbach stripe for easier and accurate observation of the meniscus line.

► Inscriptions and nominal values are printed with long lasting enamel color.

► **Automatic burettes are supplied without bottles and bellows. Bottles and bellows should be ordered separately.**



All automatic burettes are featured with an intermediate PTFE stopcock for reliable, fast and accurate measurement.

clear burettes	amber burettes	volume	pack quantity
019.01.010	019.05.010	10 ml	1 piece
019.01.025	019.05.025	25 ml	1 piece
019.01.050	019.05.050	50 ml	1 piece

volumetric measurement & liquid handling

SCHILLING BURETTES - "class AS"



➤ Manufactured from pre-vacuum calibrated borosilicate 3.3 tubing according to ISO 385 standard. Calibrated according to DIN/ISO Class "AS" standard.

➤ Conformity mark ("DE-M") and batch number printed on the body surface. Batch certificate can be downloaded from website.

➤ Clear schilling burettes are featured with a schellbach stripe.

➤ Supplied with a PTFE "needle" valve stopcock. Inscriptions and nominal values are printed with long lasting enamel color.

clear burettes	amber burettes	volume	pack quantity
020.03.010	020.05.010	10 ml	1 piece
020.03.025	020.05.025	25 ml	1 piece
020.03.050	020.05.050	50 ml	1 piece

features of Schilling burettes

Schilling burettes are described as an alternative automatic burette specially suitable for field analysis where there is always a risk of breakage.

Schilling burette set consists of a burette tubing similar to glass automatic burette and a polyethylene reservoir bottle with a stabilising stand.

Offers a rapid filling by squeezing the polyethylene reservoir bottle and fast titration through valve stopcock.

ACCESORIES for BURETTES



BOTTLES - "for automatic burettes"

➤ Manufactured from thick glass with 2000 ml volume.

➤ Grinded neck with NS 29/32 socket size perfectly fits to automatic burette's cone.

clear bottles	amber bottles	pack quantity
020.07.010	020.07.025	1 piece

BELLOW - "for automatic burettes"

➤ Manufactured from natural rubber. Tube diameter perfectly fits to all connectors.

catalogue number	bulb type	pack quantity
020.08.001	single	1 piece

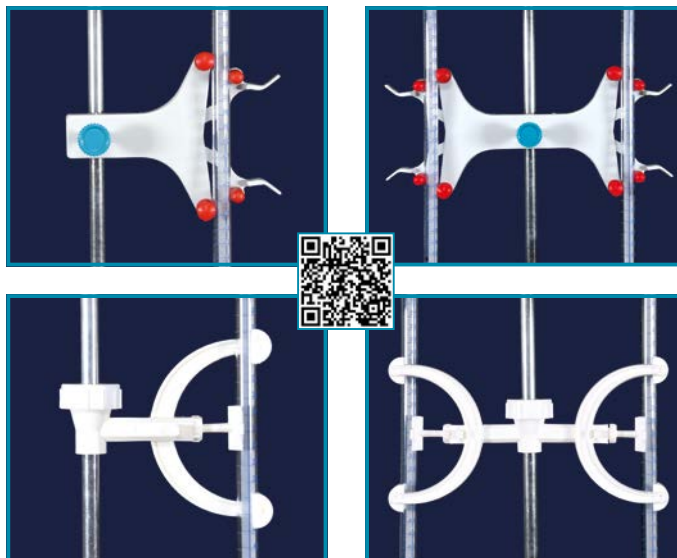

CLAMPS - "for straight burettes"

➤ Manufactured to hold one or two straight burette at a time. They firmly hold the burettes on position and offer an easy observation of volume graduations and meniscus level.

➤ Clamps can be used on rods of diameter 10 mm to 12 mm.

➤ Fixing heads are featured with flexible springs that offers easy insertion and extraction of the burettes.

catalogue number	clamp type	for holding	pack quantity
018.05.001	steel	1 burette	1 piece
018.05.002	steel	2 burettes	1 piece
018.06.001	polypropylene	1 burette	1 piece
018.06.002	polypropylene	2 burettes	1 piece

volumetric measurement & liquid handling

PIPETTES - "pasteur" - "polyethylene"

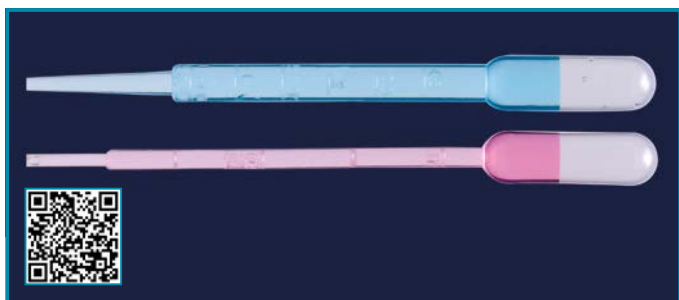

- Manufactured from low density polyethylene. Uniform wall thickness guarantees uniform suction force at all times and offers reproducible drop sizes for each use.
- Ideal for transferring and dispensing liquids safely eliminating the risk of cross contamination.
- Pipette bulb requires very small pressure force. Long and flexible stem can be bent to draw liquids from narrow vessels.
- Featured with embossed volume graduations on the body.

catalogue number	volume	product descriptions	packing specifications	pack quantity
084.02.001	3 ml	non-sterilized	in box	500 pieces
084.22.001	3 ml	gamma sterilized	single pack	100 pieces
084.02.003	1 ml	non-sterilized	in box	500 pieces
084.22.003	1 ml	gamma sterilized	single pack	100 pieces

PIPETTES - "serological" - "polystyrene"

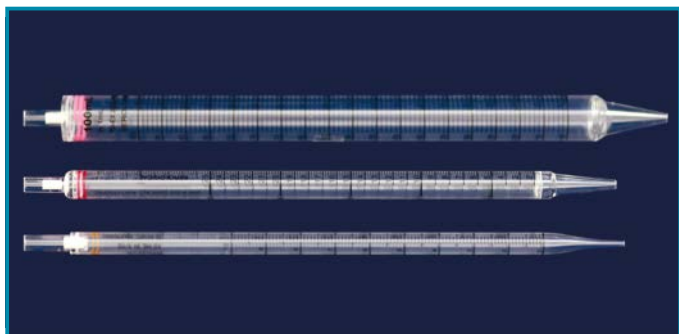

- Manufactured from virgin polystyrene with excellent optical transparency. Sterilized with gamma irradiation. Free of RNase, DNase, DNA and pyrogene.
- Smooth interior prevents cell-hanging and clumping inside the pipette wall. Pipette tip offers constant reproducible flow.
- Optimised mouthpiece perfectly fits to all types of pipette pumps and balls.
- Colour coded ring mark at suction stem allows fast identification and sourcing.
- The sharp, black, highly visible permanent graduations guarantee precise reading.

catalogue number	pipette volume	color code	box quantity
083.13.001	1 ml	yellow	500 pieces
083.13.002	2 ml	green	500 pieces
083.13.005	5 ml	blue	200 pieces
083.13.010	10 ml	orange	200 pieces
083.13.025	25 ml	red	150 pieces
083.13.050	50 ml	purple	100 pieces
083.13.100	100 ml	pink	50 pieces

DISPENSER BOX - "large"

- Manufactured from crystal clear acrylic with excellent field of vision.
- Ideal for storing and dispensing relatively large scale products such as pasteur pipettes.
- Featured with non-skid silicone feet for stable stand.
- Featured with an easy opening hinged lid. Once opened, the lid stands open for easy dispensing.
- Box offers safe and clean storage of pipettes without been effected from enviromental effects.
- Box external dimensions: 175x250x600 mm.



catalogue number	pack quantity
084.05.001	1 piece



PIPETTES - "pasteur" - "glass"



- Manufactured from neutral glass according to ISO 7712 standard.
- Thick walls provide extra strength eliminating the risk of breakage.
- Ideal for transferring and dispensing liquids safely eliminating the risk of cross contamination.
- Featured with a long drawn capillary tip. The design of the suction part allows cotton plugging.

catalogue number	length	pack quantity	box quantity
084.01.001	150 mm	250 pieces	4 packs
084.01.002	230 mm	250 pieces	4 packs

BULB - "for glass pasteur pipettes"



- Manufactured from natural rubber particularly to be used with glass pasteur pipettes.

catalogue number	pack quantity
084.03.001	100 pieces

volumetric measurement & liquid handling

PIPETTES - "glass" - "class AS" - "conformity certified"



➤ Manufactured from neutral tubing according to ISO 648 and DIN 12687 (for volumetric pipettes), ISO 385 and DIN 12699 (for graduated pipettes) standards.

➤ Calibrated according to DIN/ISO Class "AS" standard.

➤ Conformity mark ("DE-M") and batch number printed on the body surface. Batch certificate can be downloaded from website.

➤ Carefully formed and bevelled tips ensure proper flow rate. Color coded ring marks allows fast sourcing.

➤ Inscriptions and nominal values are printed with long lasting enamel color.

graduated pipettes	volumetric pipettes	volume	pack quantity
021.01.001	021.05.001	1 ml	10 pieces
021.01.002	021.05.002	2 ml	10 pieces
	021.05.003	3 ml	10 pieces
	021.05.004	4 ml	10 pieces
021.01.005	021.05.005	5 ml	10 pieces
021.01.010	021.05.010	10 ml	10 pieces
	021.05.011	11 ml	10 pieces
	021.05.015	15 ml	10 pieces
021.01.020	021.05.020	20 ml	10 pieces
021.01.025	021.05.025	25 ml	10 pieces
021.01.050	021.05.050	50 ml	10 pieces

PIPETTES - "glass" - "class A"

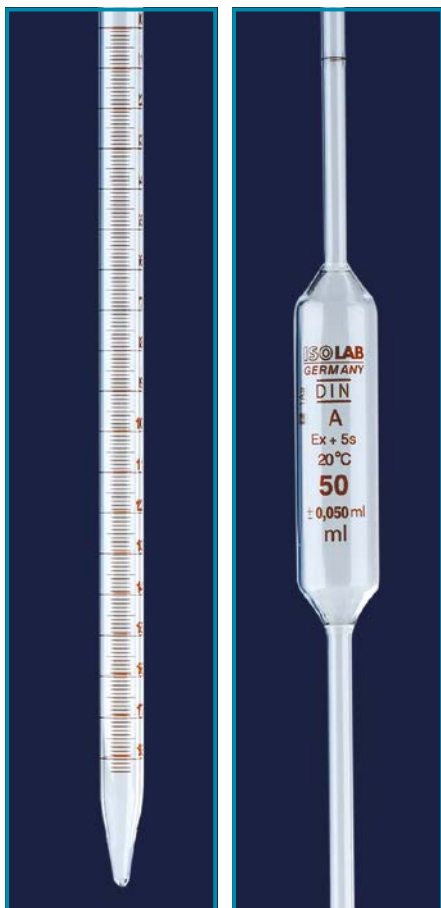

➤ Manufactured from neutral tubing according to ISO 648 and DIN 12687 & ISO 835 and DIN 12699 standards.

➤ Calibrated according to DIN/ISO Class "A" standard.

➤ Carefully formed and bevelled tips ensure proper flow rate. Color coded ring marks allows fast sourcing.

➤ Inscriptions and nominal values are printed with long lasting amber stain.

graduated pipettes	volumetric pipettes	volume	pack quantity
021.11.001	021.15.001	1 ml	10 pieces
021.11.002	021.15.002	2 ml	10 pieces
021.11.005	021.15.005	5 ml	10 pieces
021.11.010	021.15.010	10 ml	10 pieces
021.11.020	021.15.015	20 ml	10 pieces
021.11.025	021.15.020	25 ml	10 pieces
021.11.050	021.15.025	50 ml	10 pieces

Color coded ring mark at suction stem allows fast identification and sourcing.



STAND - "for pipettes" "carrousel"



➤ Manufactured from polypropylene for holding up to 94 pipettes vertically.

➤ The round carrousel stand can rotate 360° around stand axis enabling easy reach to each pipette.

➤ The grid patterned upper disc which is concentric with the carrier plate keeps the pipettes in vertical and correct position.

➤ The carrier plate consists of four concentric troughs with tapered sides and open bottoms which cradle the pipette tips protectively.

➤ Drained liquid is collected by a stationary rack at the bottom part.

catalogue number	height x diameter	pack quantity
022.01.001	48 x 23 cm	1 piece



The grid patterned upper disc which is concentric with the carrier plate keeps the pipettes in vertical and correct position.



The carrier plate consists of four concentric troughs with tapered sides and open bottoms which cradle the pipette tips protectively.

STAND - "linear"



➤ Manufactured from polypropylene for holding up to 12 pipettes horizontally. Easily dismantlable for storage and cleaning purposes.

catalogue
number

022.02.001

pack
quantity

1 piece

TRAY - "for pipettes"



➤ Manufactured from polystyrene for easy organisation of all kind of pipettes.

➤ Crenated design enables holding of large size pipettes in longitudinal direction and short size pipettes in transverse direction.

catalogue
number

022.03.001

dimensions

285 x 215 x 40 mm

pack
quantity

1 piece

TRAY - "for pipettes"



➤ Manufactured from polystyrene for easy organisation of all kind of pipettes.

➤ 1-2-5 and 10 ml pipettes can be stored at 4 different compartments. Can also be used in drawers as well as on bench tops.

catalogue
number

022.03.011

dimensions

300 x 425 x 30 mm

pack
quantity

1 piece

BOX - "for pipettes"



➤ Manufactured from AISI 304 stainless steel with rectangular form. The total box height is not adjustable.

➤ Supplied with a silicone pad that fits to the box base.

➤ Silicone pad acts as a shock absorber and prevents the risk of breakage.

catalogue
number

022.04.001

box base
dimensions

70x70 mm

box
height

210 mm

pack
quantity

1 piece

022.04.002

70x70 mm

430 mm

1 piece

BOX - "for pipettes"



➤ Manufactured from aluminium with cylindrical body form. For to carry pipettes with different height during autoclave sterilisation process. The total box height is adjustable.

➤ Supplied with a silicone pad that fits to the box base. Silicone pad acts as a shock absorber and prevents the risk of breakage.

catalogue
number

022.03.002

box
diameter

60 mm

min. & max.
box height

145-235 mm

pack
quantity

1 piece

022.03.003

60 mm

280-420 mm

1 piece

RACK - "for pipettes"



➤ Manufactured from acrylic for easy organisation of all kinds of pipettes.

➤ 4 shelves guarantee easy and fast reach of all pipettes between 1 ml to 50 ml size with in arm's reach.

➤ Angled design of the pipette shelves prevents the risk of pipettes falling out even the shelf is fully filled.

➤ Featured with magnetic clamps on both sides for arrangement of multiple box assembly.

catalogue
number

022.06.001

dimensions

290x90x400 mm

pack
quantity

1 piece

volumetric measurement & liquid handling

PIPETTE FILLERS - "pi-pump"



- A simple yet practical pipette filler for all pipettes from 2 ml to 25 ml volume range.
- Even very small volumes can be dispensed precisely.
- Pipette stem smoothly fits to the flexible silicone chuck and are firmly hold in position.
- Rotating the existing handwheel on the body upwards draws the liquid precisely to the desired level.
- Rotating the handwheel downwards let the liquid in the pipette discharge partially.
- A slight pressure applied to the fast release lever let the liquid flow-out for complete delivery.



catalogue number	for pipette volume	pack quantity
011.01.002	up to 2 ml	1 piece
011.01.010	up to 10 ml	1 piece
011.01.025	up to 25 ml	1 piece



PIPETTE FILLERS - "maxi"



- Advance pipette filler for all pipettes from 1 ml to 100 ml volume range.
- The optimised valve system allows easy draw of liquid without excess pressure.
- Pipette stem smoothly fits to the flexible silicone chuck and are firmly hold in position.
- Very easy to use; before attaching the pipette first squeeze the silicone bulb and release the air inside.
- Attach the pipette. Move the pipetting knob up-ward for filling, down-ward for discharging.
- For blow-out just push the discharge bellow.
- A replaceable hydrophobic membrane filter in the intake cone prevents cross contamination.

catalogue number	product descriptions
011.02.003	pipette filler
011.02.003.3	spare filter



PIPETTE FILLER - "macro"



- Bulb manufactured from natural rubber. Most common pipette filler for all types of pipettes up to 100 ml volume. Standard model can be used up to 10 ml pipettes. Universal model can be used up to 100 ml pipettes.
- Evacuation can be easily done by pressing the related automatic valves. Offers an easy single hand use. Pressing the valve the liquid is drawn-up to the desired level, dispensed partially or blown-out.

catalogue number	model	for pipettes	pack quantity
011.02.001	standard	up to 10 ml	1 piece
011.02.002	universal	up to 100 ml	1 piece



PIPETTE FILLER



- Simple and easily controllable pipette filler for all pipettes up to 15 ml volume.
- Very easy to use; First squeeze the bulb and release the air inside. Then attach the pipette. Release the bulb pressure and fill the pipette. For discharge squeeze the bulb again.

catalogue number	pack quantity
011.04.001	1 piece



catalogue number	for pipette volume	pack quantity
011.04.003	max 3 ml	10 pieces
011.04.005	max 5 ml	10 pieces
011.04.010	max 10 ml	10 pieces

PIPETTE FILLER

- Manufactured from silicone. Ideal for simple pipetting applications.
- Offered with three different volume capacity.



volumetric measurement & liquid handling

PIPETTE PUMP - "electrical"



- For all kinds of pipettes from 0,1 ml to 100 ml volume range.
- Ergonomic, light weight and well balanced body offers full comfort and fatigue-free pipetting.
- Powerful pump can fill a 25 ml pipette under 4 seconds.
- Pump speed can be adjusted to 8 different levels. LCD display visually shows the selected speed. Also offers gravimetric drain.
- Changeable lithium-ion batteries provide 8 hours continuous use. LCD display shows remaining battery power.
- The high-tech charger prevents over charging and provides long life cycle. 2-3 hours is required for full charge.
- Silicone adapter in the intake cone holds firmly the pipettes in position. Replaceable hydrophobic 0,45µm PTFE filter prevents cross contamination.
- Supplied with a wall mounting and a dual-position stand.

catalogue number	for pipettes	speed range	pack quantity
010.01.005	0,1 - 100 ml	adjustable	1 piece



Replaceable hydrophobic 0,45 µm PTFE filter secures cross contamination.
Catalogue No: 610.01.005

Silicone adapter in the intake cone holds firmly the pipettes in position.

PIPETTE PUMP - "electrical"



- For all kinds of pipettes from 0,1 ml to 100 ml volume range.
- Ergonomic, light weight and well balanced body offers full comfort and fatigue-free pipetting.
- Powerful pump can fill a 25 ml pipette under 4 seconds.
- Pump speed can be selected as high and low speed modes. Also offers gravimetric drain.
- Changeable lithium-ion batteries provide 8 hours continuous use. Featured with a visual red bulb low battery indicator.
- The high-tech charger prevents over charging and provides long life cycle. 2-3 hours is required for full charge.
- Silicone adapter in the intake cone holds firmly the pipettes in position. Replaceable hydrophobic 0,45µm PTFE filter prevents cross contamination.
- Supplied with a wall mounting and a single-position stand.

catalogue number	for pipettes	speed range	pack quantity
010.01.006	0,1 - 100 ml	adjustable	1 piece



Replaceable hydrophobic 0,45 µm PTFE filter secures cross contamination.
Catalogue No: 610.01.006

Silicone adapter in the intake cone holds firmly the pipettes in position.

volumetric measurement & liquid handling



BURETTE - "digital" - "manuel control"

- Guarantees reliable measuring results with bubble-free dispensing and consistent delivery.
- Discharge tube can be turned to any desired position since the body can rotate 360° round the axis.
- The angled, large and 4 digit LCD display clearly shows the titration values till to 99,99 ml and eliminate meniscus level errors.
- Continuous display of dispensed volume with zero reset feature for multiple titrations.
- PTFE plunger and borosilicate glass barrel allow dispensing of most aggressive solutions.
- Visible glass barrel allows inspection of the liquid before and during dispensing.
- Precision valve ensures easy priming and minimum waste with no back leakage into the reservoir bottle.
- Supplied with a battery with a lifetime for 60.000 titrations.
- Featured with a low battery indicator on the LCD display.

- Featured with a height adjustable telescopic intake tube that can fit to variable heights of different reservoir bottles.
- Supplied with an individual calibration certificate and various reservoir bottle neck adaptors.



The angled, large and 4 digit LCD display clearly shows the titration values till to 99,99 ml and eliminate meniscus level errors.

catalogue number	volume range	volume accuracy	pack quantity
007.01.001	50 ml	0,01 ml	1 piece

DISPENSER - "repetitive"



- Ergonomically designed and light weight dispenser for fast and simple serial dispensing of liquids.
- Perfect tool for applications where repetitive dispensing is a must and where time is valuable.
- Very easy to use; first fill the dispenser tip with the liquid similar to a syringe. Then press the pipette button for each dispensing step.
- All functions can be controlled only by three control mechanisms.
- Offers 5 volume settings and 7 different dispenser tip sizes results with 35 alternative different volumes.
- Depending on the size & volume of the tip used - it is possible to dispense between 0,5 ml to 50 ml liquid in multi-interval.
- Works on the positive displacement principle which enables dispensing of even high density and high vapour liquids.
- Dispensing volume can be selected from the volume scale on the body.

catalogue number	pack quantity
008.06.001	1 piece

DISPENSER TIPS - "repetitive"

- Dispenser tips are manufactured from clear polypropylene.
- 7 different tip sizes offer 35 alternative different volumes.
- Graduation on the side of the tips enables visual confirmation of the volume.



Adapter for 25 & 50 ml tip should be ordered separately
Cat. No: 008.06.002

catalogue number	dispenser tip volume	pack quantity
008.06.005	0.50 ml	10 pieces
008.06.012	1.25 ml	10 pieces
008.06.025	2.50 ml	10 pieces
008.06.050	5.00 ml	10 pieces
008.06.125	12.50 ml	10 pieces
008.06.250	25.00 ml	10 pieces
008.06.500	50.00 ml	10 pieces
008.06.002	adapter for 25 & 50 ml	

DISPENSERS - "advanced model"



➤ Guarantees reliable results with bubble-free dispensing of liquids. Fully autoclavable body provides high precision with consistent delivery.

➤ Available in 6 volume ranges covering a range from 2,5 ml to 100 ml.

➤ Individually calibrated according to ISO 8655 standard and supplied with a calibration certificate.

➤ All wetted parts are PTFE, FEP, PFA and borosilicate glass ensuring highest degree of chemical resistance.

➤ Springless PTFE valve manifold ensures excellent chemical compatibility and leak-proof functioning.

➤ This also ensures wiper like movement of the piston making it suitable for all kinds of crystalline liquids.

➤ PTFE piston and viton "O" ring guarantees fatigue-free, smooth, effortless piston movement and high accuracy.

➤ Dosing cylinder is protected against breakage by a polypropylene sleeve.

➤ Large volume scale printed on both sides of the body guarantees fast, easy and precise volume readings.

➤ Adapter rotates freely 360° on the bottle neck and redirects the discharge to the desired position.

➤ Easy volume setting with 180° rotating volume adjustment knob.

➤ Discharge tube cap prevents drying and accidental dropping.

➤ Supplied with 4 adaptors (28, 38, 40 & 45 mm diameter) to fit almost all available reservoir bottle necks.

➤ The telescopic extractable intake tube can be adjusted simply by pulling according to different bottle heights.

➤ Specially designed calibration tool is provided with each dispenser for convenient and fast user recalibration.

➤ **Alternative 2 dispensers:** • without recirculation valve • with recirculation valve



Volume scale printed on both sides of the body guarantees precise volume readings.



Built in recirculation valve prevents reagent loss during purging,



Adapter rotates freely 360° on the bottle neck and redirects the discharge to the desired position.



Fast, easy and reliable volume setting with 180° rotating volume adjustment knob.



Discharge tube cap reduces contact with the air and prevents drying. Also prevents accidental dropping.



Supplied in a perfectly designed modern and sturdy box featured for compartments for every piece.

volume	without re-circulation valve	with re-circulation valve	pack quantity
0.3 - 2.5 ml	008.12.002	008.15.002	1 piece
0.5 - 5 ml	008.12.005	008.15.005	1 piece
1.0 - 10 ml	008.12.010	008.15.010	1 piece
2.5 - 30 ml	008.12.030	008.15.030	1 piece
5.0 - 60 ml	008.12.060	008.15.060	1 piece
10.0 - 100 ml	008.12.100	008.15.100	1 piece

volumetric measurement & liquid handling

MICROPIPETTES - "adjustable volume"

- 9 models covers volume range from 0,25 µl to 10 ml and combines all the requirements of a modern pipette.
- Each pipette is individually calibrated according to ISO 8655 and certified. Supplied with an individual calibration certificate.
- Ultralight and well balanced body offers greatest comfort for extended pipetting periods.
- Contoured and ergonomic body shape fits perfectly to all hand sizes.
- Guarantees fast and easy volume setting with single hand. Volume display is always fully visible.
- Thumb friendly soft spring pipetting system reduce plunger pressure.
- Ergonomic finger hook offers comfortable handling and to take the weight for a more relaxed grip.
- Tip ejector with large pad reduces thumb pressure workload and guarantees easy tip ejection. (except 011.05.910)

non-autoclavable pipettes	autoclavable pipettes	volume range	pack quantity
011.06.002	011.05.002	0.1 - 2.5 µl	1 piece
011.06.010	011.05.010	0.5 - 10 µl	1 piece
011.06.020	011.05.020	2 - 20 µl	1 piece
011.06.050	011.05.050	5 - 50 µl	1 piece
011.06.100	011.05.100	10 - 100 µl	1 piece
011.06.200	011.05.200	20 - 200 µl	1 piece
011.06.901	011.05.901	100 - 1000 µl	1 piece
011.06.905	011.05.905	1000 - 5000 µl	1 piece
011.06.910	011.05.910	1000 - 10000 µl	1 piece



PIPETTING RESERVOIRS - "non-sterile & sterile" - "disposable"



Bottoms with a sloping "V" form and tapered in a narrow through.



- Manufactured from polystyrene featured with thick walls and crush-resistant corners as single, disposable use.
- Offers a clean, practical and economical alternative to all other re-usable pipetting reservoirs.
- Featured with a visible volume marking on the side wall.
- Large pour-back spouts at the corners guarantee safe pouring back the remaining liquid in to the original container.
- Easily stackable due to the tapered body form for reducing storage space. Liquid reservoirs do not stick to each other even stacked.
- Bottoms with a sloping "V" form and tapered in a narrow through guarantee maximum liquid recovery.

catalogue number	volume	product specifications	pack quantity
006.03.030	30 ml	non-sterile	100 pieces
006.13.030	30 ml	gamma sterile	10 pieces
006.03.055	55 ml	non-sterile	100 pieces
006.13.055	55 ml	gamma sterile	10 pieces
006.03.110	110 ml	non-sterile	100 pieces
006.13.110	110 ml	gamma sterile	10 pieces

MICROPIPETTES - "adjustable volume" - "autoclavable" - "for research"



- ▶ One pipette with exchangeable fix-volume controllers solves all your problems. Offer as single channel and 8 channel models.
- ▶ 9 models cover volume range from 0,2 µl to 10 ml and fulfill all the requirements of a modern pipette.
- ▶ Autoclavable, ultralight and well balanced body offers greatest comfort for extended pipetting periods.
- ▶ PP/PVDF/ anodised aluminium and stainless steel body construction guarantees the highest level of accuracy and precision.
- ▶ Dual "O" ring technology guarantees best tip fit. Outer "O" rings makes tip loading easy.
- ▶ Fast and easy volume setting with single hand. Volume setting requires 50% fewer turns compared to some brands.
- ▶ Volume lock prevents accidental volume changes during operation. Volume display is always fully visible.
- ▶ Thumb friendly soft spring pipetting system reduces plunger pressure by up to 50% and guarantees the whole procedure more comfortable.
- ▶ Ergonomic finger hook offers comfortable handling and to take the weight for a more relaxed grip.
- ▶ Color-coded tip ejector reduces thumb workload by 70 % compared with other brands.
- ▶ Large pad of tip ejector guarantees easy tip ejection.
- ▶ Each pipette is individually calibrated and certified. Serial number is printed on each pipette.

volume range	single channel	inaccuracy	imprecision %	8 channel	inaccuracy	imprecision %	color code	pack quantity
0.2 - 2.0 µl	011.20.002	12.00/2.00	6.00/1.00					1 piece
0.5 - 10 µl	011.20.010	2.50/1.00	1.80/0.50	011.21.010	5.00/2.00	3.60/1.00		1 piece
2 - 20 µl	011.20.020	5.00/1.00	1.50/0.30					1 piece
5 - 50 µl	011.20.050	2.00/1.00	1.20/0.30	011.21.050	3.20/1.40	1.60/0.60		1 piece
10 - 100 µl	011.20.100	2.50/0.70	1.00/0.20					1 piece
20 - 200 µl	011.20.200	2.50/0.60	0.70/0.20	011.21.200	1.80/1.20	0.80/0.40		1 piece
30 - 300 µl		1.66/1.40	0.60/0.30	011.21.300	1.66/1.40	0.60/0.30		1 piece
100 - 1000 µl	011.20.901	2.00/0.80	0.60/0.20					1 piece
1 - 5 ml	011.20.905	1.20/0.60	0.30/0.15					1 piece
1 - 10 ml	011.20.910	3.00/0.60	0.60/0.15					1 piece

volume lock feature



Select the desired volume and lock the indicator.

- ▶ Volume lock feature allows selecting the desired volume and locking the indicator to achieve a more reliable pipetting experience.
- ▶ Locking feature prevents accidental volume changes during pipetting procedures.
- ▶ Simply slide the button to the upper position to lock or lower to release.

dual "O" ring

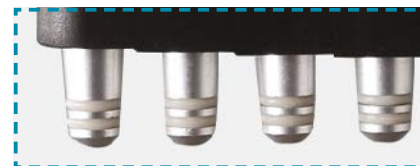

Dual "O" ring technology: guarantees best tip fit.

- ▶ Outer "O" rings make tip loading easier. The first "O" ring creates a smooth seal while the second "O" ring creates a positive stop to ensure that the tips are airtight, sealed, and can be ejected with the smallest amount of force.

volumetric measurement & liquid handling



PIPETTE TIPS - “precision” - “for research”

- Manufactured from FDA approved polypropylene with consistent quality.
- Manufactured in fully automatic, human touch-free, clean room facilities as DNase, RNase, Pyrogen free. Certified on lot basis.
- Low retention is achieved by a special resin which offers minimum retention and maximum accuracy allowing complete retrieval of precious samples.
- Maximum sample recovery eliminates sample hold-up, providing the most accurate sample delivery.
- Exclusive molding technology reduces the sample loss, saves costly reagents and maximises accuracy and precision.
- Filtered tips prevents cross contamination from sample to sample by creating a physical barrier in the tip to inhibit and block aerosols.
- Optimised shape fits to all common pipettes to give perfect seal between the pipette tip and the pipette shaft.
- Different lengths within the same volume range for different applications.



Alternative packing options:

Puncture resistant bags:

- Base with a wide gusset enables self-standing and allows single-handed access.
- Heat sealed above the zip-lock closure, product integrity and cleanliness is assured right down to the last tip.

Durable boxes:

- Easy to open-close hinged lid boxes with internal rib structure provide an extremely strong platform.
- Features recessed wells to ensure perfect tip allignment.



catalogue number	product descriptions	packing specifications
T-B-010	pipette tip - ISOLAB - clear - 10 µl - bag	1000 pieces / bag
T-R-010	pipette tip - ISOLAB - clear - 10 µl - box	96 pieces / box
T-R-S-010	pipette tip - ISOLAB - clear - 10 µl - box - sterile	96 pieces / box
TF-010	pipette tip - filter - ISOLAB - clear - low retention - 10 µl - bag	1000 pieces / bag
TF-R-S-010	pipette tip - filter - ISOLAB - clear - low retention - 10 µl - box - sterile	96 pieces / box
T-B-011	pipette tip - ISOLAB - clear - long - 10 µl - bag	1000 pieces / bag
T-R-011	pipette tip - ISOLAB - clear - long - 10 µl - box	96 pieces / box
T-R-S-011	pipette tip - ISOLAB - clear - long - 10 µl - box - sterile	96 pieces / box
TF-011	pipette tip - filter - ISOLAB - clear - low retention - long - 10 µl - bag	1000 pieces / bag
TF-R-S-011	pipette tip - filter - ISOLAB - clear - low retention - long - 10 µl - box - sterile	96 pieces / box
TF-50	pipette tip - ISOLAB - with filter - clear - 50 µl - bag	1000 pieces / bag
TF-R-S-50	pipette tip - ISOLAB - clear - low retention - 50 µl - box - sterile	96 pieces / box
TF-100	pipette tip - filter - ISOLAB - clear - low retention - 100 µl - bag	1000 pieces / bag
TF-R-S-100	pipette tip - filter - ISOLAB - clear - low retention - 100 µl - box - sterile	96 pieces / box
T-B-200	pipette tip - ISOLAB - clear - 200 µl - bag	1000 pieces / bag
T-R-200	pipette tip - ISOLAB - clear - 200 µl - box	96 pieces / box
T-R-S-200	pipette tip - ISOLAB - clear - 200 µl - box - sterile	96 pieces / box
TF-200	pipette tip - filter - ISOLAB - clear - low retention - 200 µl - bag	1000 pieces / bag
TF-R-S-200	pipette tip - filter - ISOLAB - clear - low retention - 200 µl - box - sterile	96 pieces / box
T-B-300	pipette tip - ISOLAB - clear - 300 µl - bag	1000 pieces / bag
T-R-300	pipette tip - ISOLAB - clear - 300 µl - box	96 pieces / box
T-R-S-300	pipette tip - ISOLAB - clear - 300 µl - box - sterile	96 pieces / box
TF-300	pipette tip - filter - ISOLAB - clear - low retention - 300 µl - bag	1000 pieces / bag
TF-R-S-300	pipette tip - filter - ISOLAB - clear - low retention - 300 µl - box - sterile	96 pieces / box
T-B-1000	pipette tip - ISOLAB - clear - 1000 µl - bag	1000 pieces / bag
T-R-1000	pipette tip - ISOLAB - clear - 1000 µl - box	96 pieces / box
T-R-S-1000	pipette tip - ISOLAB - clear - 1000 µl - box - sterile	96 pieces / box
TF-1000	pipette tip - filter - ISOLAB - clear - low retention - 1000 µl - bag	1000 pieces / bag
TF-R-S-1000	pipette tip - filter - ISOLAB - clear - low retention - 1000 µl - box - sterile	96 pieces / box
T-B-1250	pipette tip - ISOLAB - clear - 1250 µl - bag	1000 pieces / bag
T-R-1250	pipette tip - ISOLAB - clear - 1250 µl - box	96 pieces / box
T-R-S-1250	pipette tip - ISOLAB - clear - 1250 µl - box - sterile	96 pieces / box
TF-1250	pipette tip - filter - ISOLAB - clear - low retention - 1250 µl - bag	1000 pieces / bag
TF-R-S-1250	pipette tip - filter - ISOLAB - clear - low retention - 1250 µl - box - sterile	96 pieces / box
T-B-5000	pipette tip - ISOLAB - clear - 5000 µl	250 pieces / bag
T-R-S-5000	pipette tip - ISOLAB - clear - 5000 µl - box - sterile	50 pieces / box
T-B-10000	pipette tip - ISOLAB - clear - 10000 µl	200 pieces / bag
T-R-S-10000	pipette tip - ISOLAB - clear - 10000 µl - box - sterile	25 pieces / box

maximum sample recovery



Isolab tip after dispensing 100 µl sample.

ISOLAB tips are made from low liquid retention resins that provides superior sample recovery while increasing accuracy and reproducibility.

- Allows for complete retrieval of precious samples.
- Saves costly reagents by reducing sample loss.
- Optimizes accuracy of the pipettor and also transfer of blood plasma.
- Avoids denaturation of nucleic acids and protein samples.



Other brand standart tip after dispensing 100 µl sample.

filter tips

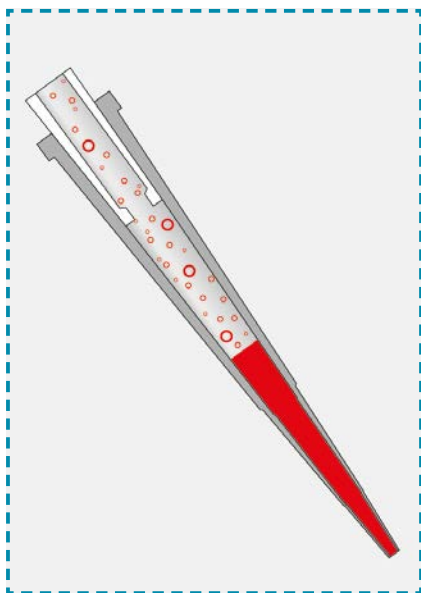

ISOLAB filter tips offer the ultimate in protection against contamination.

- Filter barriers block aerosols by coalescing radioactive, chemical or biological contaminants before they can come in contact of pipettor shaft.
- Their usage is mostly essential in critical applications such as PCR, DNA sequencing and other techniques that involve the use of vaporous, biohazardous or corrosive material.
- Tip filters also act as a safety barrier against accidental over-pipetting of liquids without risk of sample lock-up.

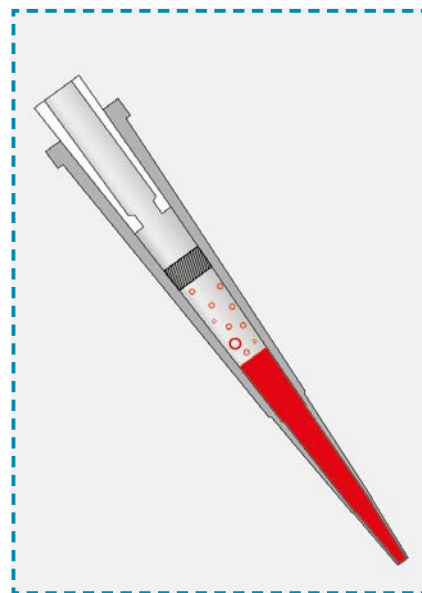

PIPETTE TIPS - "economical"

- Manufactured from high quality pure polypropylene which is highly resistant to chemicals and thermal effects.

- Produced to match wide variety of pipettors for secure sealing and easy tip ejecting.

- Uniformity in size and shape allows perfect fitting with almost all micropipettes.

- Flashfree and uniform delivery orifice for consistent accuracy and reproducible sample delivery.

- Thin wall and small surface area at the tip minimize the possible tip retaining samples droplets.

catalogue number	capacity	color	pack quantity
005.01.001	10 µl	clear	1000 pcs
005.01.002	200 µl	yellow	1000 pcs
005.01.003	1000 µl	blue	500 pcs
005.01.004	5 ml	clear	250 pcs
005.01.005	10 ml	clear	100 pcs
005.01.015	10 ml	clear	100 pcs

- Please kindly order 005.01.005 pipette tips for 011.05.910

- Please kindly order 005.01.015 pipette tips for 011.06.910 and 011.20.910

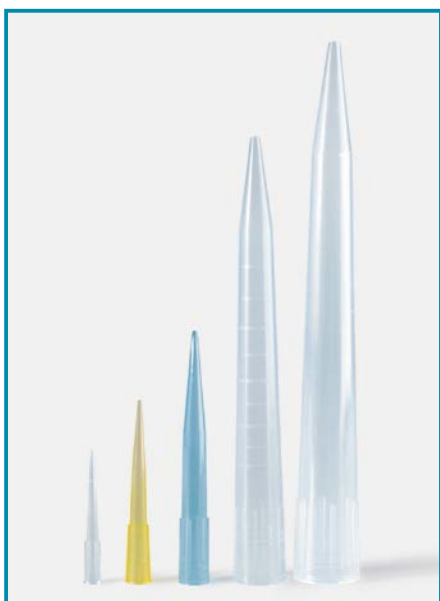

volumetric measurement & liquid handling



STAND - "micropipette" "carrousel"

- Manufactured from polypropylene for using with most common micropipette brands.
- This space saving, robust stand can hold up to 6 pipettes comfortably.
- The round carrousel stand can rotate 360° around the axis enabling easy reach of any pipette.

catalogue number	base diameter	total height	pack quantity
006.11.005	160 mm	320 mm	1 piece



STAND - "micropipette" "linear"

- Manufactured from polypropylene for using with most common micropipette brands.
- Offers practical and easy direct access to micropipettes.
- This space saving, robust stand can hold up to 6 pipettes comfortably.



Linear micropipette stand can also hold multi-channel pipettes.

catalogue number	dimensions	pack quantity
006.11.006	143 x 290 x 290 mm	1 piece



STAND - "micropipette" "adjustable"

- Manufactured from acrylic with ergonomic angled body form with adjustable pipette holding option.
- Can be used with most pipette brands.
- Depending on the stand size enables easy holding and handling of 4 or 6 single channel pipettes.



The unique adjustable pipette holding design guarantees the use with different height pipettes.

catalogue number	dimensions	pack quantity
006.12.004	130 x 260 x 220 mm	1 piece
006.12.006	150 x 380 x 220 mm	1 piece



STAND - "micropipette" - "with bin"

- Manufactured from acrylic with a bin. The top support can hold 4 single channel pipettes.
- Generous opening of the bin provides easy and safe access to partitions.
- Cover is featured with easy opening sliding lid. Once opened, the lid stays open and enables easy filling and dispensing.
- Bin guarantees safe and clean storage of box pipette tips without been effected from dust, moisture and other environmental effects.
- Featured with non-skid silicone feet for safe and stable stand on the laboratory desks.

catalogue number	dimensions	pack quantity
006.05.001	200 x 178 x 173 mm	1 piece



Bin guarantees safe and clean storage of pipette tips without been effected from dust, moisture and other environmental effects.

Cover is featured with easy opening sliding lid. Once opened, the lid stays open and enables easy filling and dispensing.



ISOLAB

Laborgeräte GmbH



lab consumables & labware



lab consumables & labware



BEAKERS - "glass"

➤ Manufactured from heat resistant, borosilicate glass 3.3 according to ISO 3819 and DIN 12331 standards.

➤ Thick wall, heavy base and reinforced rim prevent breakage.

catalogue number	volume	pack quantity
025.01.005	5 ml	10 pieces
025.01.010	10 ml	10 pieces
025.01.025	25 ml	10 pieces
025.01.050	50 ml	10 pieces
025.01.100	100 ml	10 pieces
025.01.150	150 ml	10 pieces
025.01.250	250 ml	10 pieces
025.01.400	400 ml	10 pieces
025.01.600	600 ml	10 pieces
025.01.800	800 ml	10 pieces
025.01.901	1000 ml	10 pieces
025.01.902	2000 ml	6 pieces
025.01.905	5000 ml	1 piece
025.01.910	10000 ml	1 piece

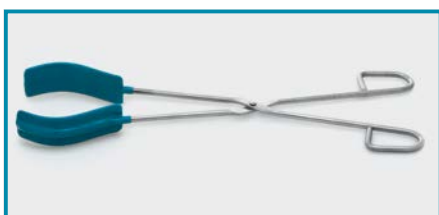

Various beaker tongs can be selected from catalogue page no 52.



BEAKERS - "polypropylene" - "embossed & printed scale"

➤ Manufactured from ultra clear polypropylene according to ISO 7056 standard with thick walls. Resistant to most acids, bases and many commonly used solvents. Functional large spout minimize possible spills during liquid transfer.

embossed scale	volume	pack quantity
026.01.025	25 ml	1 piece
026.01.050	50 ml	1 piece
026.01.100	100 ml	1 piece
026.01.250	250 ml	1 piece
026.01.500	500 ml	1 piece
026.01.901	1000 ml	1 piece
026.01.902	2000 ml	1 piece



BEAKERS - "stainless steel"

➤ Manufactured from AISI 304 grade stainless steel.

➤ Highly polished smooth interior enables much easier cleaning.

catalogue number	volume	pack quantity
025.04.100	100 ml	1 piece
025.04.250	250 ml	1 piece
025.04.500	500 ml	1 piece
025.04.901	1000 ml	1 piece



blue printed scale	volume	pack quantity
026.03.025	25 ml	1 piece
026.03.050	50 ml	1 piece
026.03.100	100 ml	1 piece
026.03.250	250 ml	1 piece
026.03.500	500 ml	1 piece
026.03.901	1000 ml	1 piece
026.03.902	2000 ml	1 piece

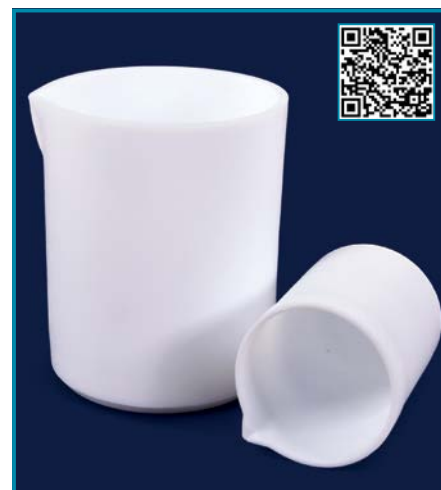

BEAKERS - "PTFE"

➤ Manufactured from chemically inert PTFE with excellent chemical resistance, and high temperature resistance between -200°C to +260°C.

catalogue number	volume	pack quantity
025.03.050	50 ml	1 piece
025.03.100	100 ml	1 piece
025.03.250	250 ml	1 piece
025.03.500	500 ml	1 piece
025.03.901	1000 ml	1 piece



BEAKERS WITH HANDLE - "P.P" - "embossed & printed scale"

- Manufactured from ultra clear polypropylene according to ISO 7056 standard with thick walls. Resistant to most acids, bases and many commonly used solvents.
- Functional large spout minimize possible spills during liquid transfer.
- Easily stackable due to the tapered body form for reducing storage space.

embossed scale	volume	pack quantity
026.02.250	250 ml	1 piece
026.02.500	500 ml	1 piece
026.02.901	1000 ml	1 piece
026.02.902	2000 ml	1 piece
026.02.903	3000 ml	1 piece

blue printed	volume	pack quantity
026.04.250	250 ml	1 piece
026.04.500	500 ml	1 piece
026.04.901	1000 ml	1 piece
026.04.902	2000 ml	1 piece
026.04.903	3000 ml	1 piece

BEAKERS WITH HANDLE "stainless steel"

- Manufactured from AISI 304 grade stainless steel.
- Highly polished smooth interior enables much easier cleaning.
- Moulded graduations on the side wall offer easy volume identification.

catalogue number	volume	pack quantity
025.05.500	500 ml	1 piece
025.05.901	1000 ml	1 piece
025.05.902	2000 ml	1 piece

FLASKS - "glass" "round & flat bottom"

➤ Manufactured from heat resistant, borosilicate glass 3.3 according to ISO 1773 standard.

➤ Thick wall, heavy base and reinforced rim prevent breakage.



round bottom	volume	pack quantity
029.02.050	50 ml	10 pieces
029.02.100	100 ml	10 pieces
029.02.250	250 ml	10 pieces
029.02.500	500 ml	10 pieces
029.02.901	1000 ml	10 pieces
029.02.902	2000 ml	6 pieces
029.02.904	4000 ml	1 piece
029.02.906	6000 ml	1 piece
029.02.910	10000 ml	1 piece

flat bottom	volume	pack quantity
029.01.050	50 ml	10 pieces
029.01.100	100 ml	10 pieces
029.01.250	250 ml	10 pieces
029.01.500	500 ml	10 pieces
029.01.901	1000 ml	10 pieces
029.01.902	2000 ml	6 pieces
029.01.904	4000 ml	1 piece
029.01.906	6000 ml	1 piece
029.01.910	10000 ml	1 piece

Various flask stands can be selected from catalogue page no 99.

lab consumables & labware

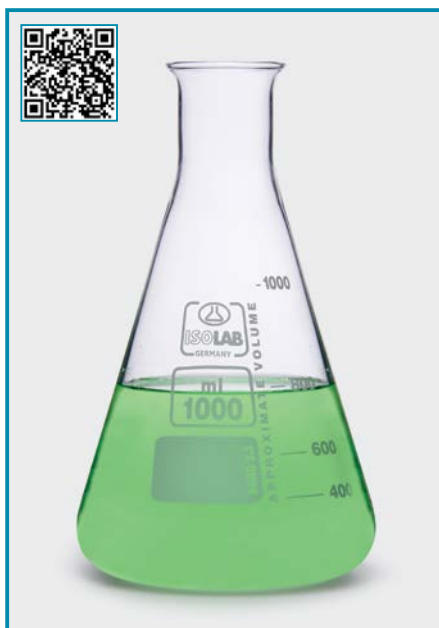

ERLENMEYERS - "clear" "glass" - "narrow neck"

➤ Manufactured from heat resistant, borosilicate glass 3.3 according to ISO 1773 standard.

➤ Thick wall, heavy base and reinforced rim prevent breakage.

catalogue number	volume	pack quantity
027.01.025	25 ml	10 pieces
027.01.050	50 ml	10 pieces
027.01.100	100 ml	10 pieces
027.01.250	250 ml	10 pieces
027.01.300	300 ml	10 pieces
027.01.500	500 ml	10 pieces
027.01.901	1000 ml	10 pieces
027.01.902	2000 ml	6 pieces
027.01.903	3000 ml	1 piece
027.01.905	5000 ml	1 piece



ERLENMEYERS - "clear" "glass" - "screw cap"

➤ Manufactured from heat resistant, borosilicate glass 3.3 with a leak-proof screw cap.

➤ Thick wall, heavy base and reinforced rim prevent breakage.

➤ Supplied with a polypropylene screw cap with large ridges for increased grip.

➤ Unique internal flanged design of the caps guarantees leak-proof closure.

catalogue number	neck size	volume	pack quantity
027.03.100	GL 32	100 ml	1 piece
027.03.250	GL 32	250 ml	1 piece
027.03.500	GL 32	500 ml	1 piece
027.03.901	GL 32	1000 ml	1 piece



ERLENMEYERS - "clear" "polypropylene" - "screw cap"

➤ Manufactured from clear polypropylene.

➤ Thick wall, heavy base and reinforced rim prevent breakage.

➤ Supplied with a polypropylene screw cap with large ridges for increased grip.

➤ Unique internal flanged design of the caps guarantees leak-proof closure.

catalogue number	neck size	volume	pack quantity
028.03.050	GL 40	50 ml	1 piece
028.03.100	GL 40	100 ml	1 piece
028.03.250	GL 52	250 ml	1 piece
028.03.500	GL 52	500 ml	1 piece
028.03.901	GL 52	1000 ml	1 piece

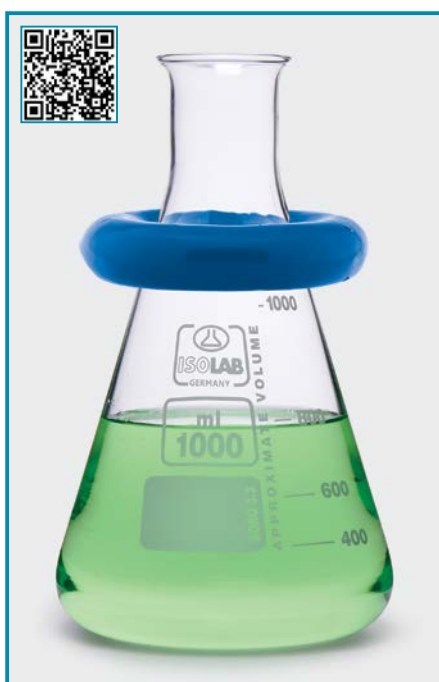

STABILISING RINGS - "for erlenmeyers & flasks"

➤ Manufactured from heavy alloy with different internal diameters for perfect fit to the necks of various volume erlenmeyers and flasks.

➤ Can fit neatly around the neck of erlenmeyers and other flasks preventing falling over or floating risks in water baths.

➤ Soft vinyl coated ring surface prevents scratching the glass surface during use.



catalogue number	internal diameter	external diameter	recommended for	pack quantity
027.11.048	48 mm	85 mm	100 ml - 500 ml	1 piece
027.11.056	56 mm	100 mm	250 ml - 1000 ml	1 piece
027.11.061	61 mm	115 mm	500 ml - 2000 ml	1 piece
027.11.074	74 mm	129 mm	1000 ml - 4000 ml	1 piece



Featured with 4 integrated baffles for efficient mixing. Baffles create a turbulent flow, enlarge gas exchange surface and increase oxygen intake.

ERLENMEYERS - "baffled - straight neck - for cell culture"

➤ Manufactured from borosilicate glass. Featured with 4 integrated baffles for efficient mixing.

➤ Baffles create a turbulent flow, enlarge gas exchange surface and increase oxygen intake. Baffles also allow stable swirling for effective mixing.

➤ Widely used in microbiology for the preparation of microbial suspension culture. Ideal for cultivating *S. Cerevisiae* and aerobic bacteria cultures.

➤ Thick wall, heavy base and reinforced rim prevent breakage. Supplied without caps.

catalogue number	volume	neck diameter	largest outer dia.	height	pack quantity
027.06.100	100 ml	38 mm	64 mm	112 mm	1 piece
027.06.250	250 ml	38 mm	85 mm	145 mm	1 piece
027.06.500	500 ml	38 mm	105 mm	182 mm	1 piece
027.06.901	1000 ml	38 mm	129 mm	230 mm	1 piece
027.06.902	2000 ml	38 mm	165 mm	275 mm	1 piece



CAP - "aluminium"

➤ Manufactured from aluminium for perfect fit to the necks of glass baffled erlenmeyers with straight neck.

➤ Chrome nickel springs grip to the neck of the outer wall of the vessel.

catalogue number	pack quantity
027.06.101	1 piece



STOPPER - "cellulose"

➤ Manufactured from additive free autoclavable. Air permeable, actively breathing best quality cellulose.

➤ Provide excellent sealing for microbiological samples in tissue culture tubes, flasks etc.

catalogue number	pack quantity
051.24.009	10 pieces

ERLENMEYERS - "for cell culture" - "sterile"

➤ Manufactured from autoclavable PETG. Caps are manufactured from polypropylene.

➤ Widely used for the preparation of suspension cultures both in cell culture and microbiological applications such as *E.coli*, plant callus, etc.



volume	catalogue number	cap type	catalogue number	cap type	pack quantity
250 ml	027.17.250	plug	027.18.250	filter	12 pieces
500 ml	027.17.500	plug	027.18.500	filter	12 pieces
1000 ml	027.17.901	plug	027.18.901	filter	6 pieces

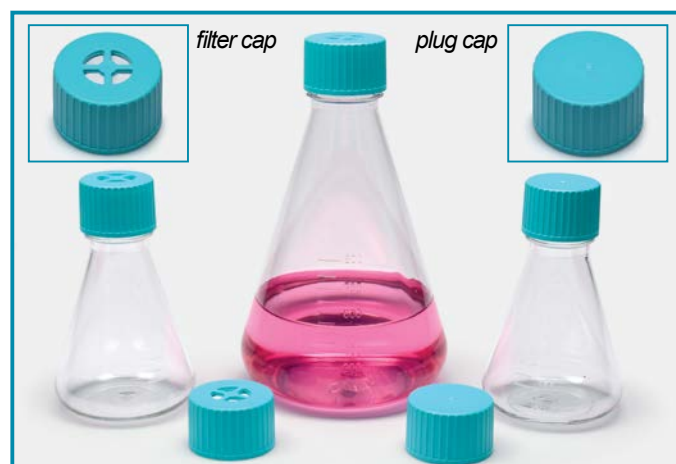

lab consumables & labware

BOTTLES - "ISO" - "borosilicate glass"

- Manufactured from heat resistant, durable borosilicate glass with thick walls and crush-resistant corners.
- These impact resistant, excellently thermal stable bottles are autoclavable at 121°C. Caps should not be closed during autoclaving.
- Angled neck form allows unrestricted liquid flow out without leaving any residue at the bottle neck.
- A large GL 45 bottle neck provides easy filling and pouring. Unique design pouring ring prevents drops and spillage.
- Caps are made from polypropylene with large ridges with increased grip. Cap inner design ensures hermetical and leak-proof closure.
- Volume graduations on wall side offers better liquid level viewing. Graduations and inscriptions are printed with white enamel.

Color coded caps enable easy and practical identification of bottle content. Color coded caps can be selected from page no 69.



volume	neck NS size	clear bottles	pack quantity	amber bottles	pack quantity
100 ml	GL 45	061.01.100	10 pieces	061.02.100	1 piece
250 ml	GL 45	061.01.250	10 pieces	061.02.250	1 piece
500 ml	GL 45	061.01.500	10 pieces	061.02.500	1 piece
1000 ml	GL 45	061.01.901	10 pieces	061.02.901	1 piece
2000 ml	GL 45	061.01.902	4 pieces	061.02.902	1 piece
3000 ml	GL 45	061.01.903	1 piece	061.02.903	1 piece
5000 ml	GL 45	061.01.905	1 piece	061.02.905	1 piece
10000 ml	GL 45	061.01.910	1 piece	061.02.910	1 piece
20000 ml	GL 45	061.01.920	1 piece	061.02.920	1 piece



COATED BOTTLES - "glass" - "clear & amber"

- When handling dangerous and/or valuable solutions coated bottles are highly recommended.
- They are featured with identical technical specifications of clear and amber bottles with codes 061.01.xxx and 061.02.xxx.
- Bodies of these bottles are coated with a special formulated coating which reduces the impacts. Coating covers the body like a protective glove and holds the broken parts unscattered.
- The coating also holds the broken glass together so that the leakage will be minimum. In most of the cases this coating keeps the solutions still inside the flask body without leakage.
- The coating is highly transparent and can resist up to 135°C with maximum period of 30 minutes. These bottles can be cleaned at maximum 95°C and can be repeatedly autoclaved at 121°C.
- Coated bottles should not be exposed directly to open flame.

volume	neck NS size	coated clear bottles	coated amber bottles	pack quantity
100 ml	GL 45	061.01.100C	061.02.100C	1 piece
250 ml	GL 45	061.01.250C	061.02.250C	1 piece
500 ml	GL 45	061.01.500C	061.02.500C	1 piece
1000 ml	GL 45	061.01.901C	061.02.901C	1 piece
2000 ml	GL 45	061.01.902C	061.02.902C	1 piece



BOTTLES - "ISO" - "polypropylene"



Sterile bottles are manufactured at aseptically sterile production halls and then sent to gamma sterilisation.

Such informations as lot number, production and expiry dates etc. are indicated on the packing.

- Manufactured from special formulated polypropylene with thick walls and crush-resistant corners.
- Featured with high transparency and best chemical heat tolerance.
- These impact resistant, excellently thermal stable bottles are autoclavable at 121°C. Caps should not be closed during autoclaving.
- Angled neck form allows unrestricted liquid flow out without leaving any residue at the bottle neck.
- A large GL 45 bottle neck provides easy filling and pouring. Unique design of the neck with moulded pouring ring prevents drops and spillage.
- Cap with large ridges with increased grip featured with self lock and internal security ring. Cap inner design ensures hermetical and leak-proof closure.
- Embossed volume graduations on wall side offers better liquid level viewing and reproducible filling of the bottle without the need of a measuring cylinder.

➤ **Alternative 2 bottles:** ➤ **Clear bottles**
➤ **Amber bottles**

- Clear bottles are manufactured from very clear polypropylene resulting with high transparency and for better view of the bottle content.
- Amber bottles are manufactured from special formulated polypropylene preventing UV light penetration into the flask yet still offering high transparency.

➤ **Alternative 2 products:** ➤ **Non-sterile bottles**
➤ **Gamma sterile bottles**

- Sterile bottles are manufactured at aseptically sterile production halls and then send to gamma sterilisation. Such informations as lot number, production and expiry dates etc are indicated on the packing.

clear bottles non-sterile	clear bottles gamma sterile	amber bottles non-sterile	amber bottles gamma sterile	neck size	volume	pack quantity
061.15.100	061.16.100	061.17.100	061.18.100	GL 45	100 ml	100 pieces
061.15.250	061.16.250	061.17.250	061.18.250	GL 45	250 ml	100 pieces
061.15.500	061.16.500	061.17.500	061.18.500	GL 45	500 ml	100 pieces
061.15.901	061.16.901	061.17.901	061.18.901	GL 45	1000 ml	50 pieces
061.15.902	061.16.902	061.17.902	061.18.902	GL 45	2000 ml	50 pieces



Unique design of the cap with intended top plate guarantees tight and leakproof closure.



Integral security ring of the cap ensures safe and untouched protection of the bottle content.



Caps are made from robust and thick polyethylene with large ridges for increased grip.



Unique neck design with moulded pouring ring prevents drops and liquid splash.

lab consumables & labware

BOTTLES - "square" - "wide neck" - "polyethylene"

- Manufactured from polyethylene with thick walls and crush-resistant corners.
 - A large bottle neck provides easy filling and pouring.
 - Cap offers increased grip. Featured with an insert plug for hermetical and leak-proof closure.
 - Bottle neck and the cap carry holes for enabling the insertion of the security seal wire.
 - The space between the cap and the insert plug can be used for securing confidential notes.
 - Embossed volume graduations on wall side offers better liquid level viewing and reproducible filling of the bottle without the need of a measuring cylinder.
- **Alternative 2 bottles:**
- **Clear bottles**
 - **Amber bottles**
- Clear bottles are manufactured from very clear P.E resulting with high transparency and for better view of the bottle content.
 - Amber bottles are manufactured from special formulated P.E preventing UV light penetration into the flask yet still offering high transparency.



clear bottles	amber bottles	bottle volume	dimensions	pack quantity
061.07.050	061.08.050	50 ml	37x39x73 mm	50 pieces
061.07.100	061.08.100	100 ml	50x45x90 mm	50 pieces
061.07.250	061.08.250	250 ml	64x57x112 mm	50 pieces
061.07.500	061.08.500	500 ml	85x72x140 mm	50 pieces
061.07.901	061.08.901	1000 ml	104x82x173 mm	50 pieces
061.07.902	061.08.902	2000 ml	134x100x210 mm	50 pieces



The space between cap and insert plug can be used for private and confidential notes.

SECURITY SEALS

- Security seal is used to ensure the safety locking and durability of the product inside the bottles.
- 4 different colors are used to identify among the seals with identification numbers printed on the seal plate.



061.09.0B1 061.09.0R1 061.09.0Y1 061.09.0G1

catalogue number	color	pack quantity
061.09.0B1	blue	10 pieces
061.09.0R1	red	10 pieces
061.09.0Y1	yellow	10 pieces
061.09.0G1	green	10 pieces



Insert the seal wire through the holes of both the cap and bottle itself. Then insert the wire into the hole of the seal as shown.



Last step is to wind the seal key clockwise until the seal wire gets tight enough to provide optimum security lock.

SECURITY SEAL CUTTER

- Security seal cutter is a perfect tool to cut security seal wires easily.

catalogue number	pack quantity
061.20.001	1 piece



BOTTLES - "glass" - "wide neck"

- Manufactured from neutral glass with thick walls and crush-resistant corners.
- Ideal for safe storage and transportation of liquids and powders.
- Thick wall, heavy base and reinforced rim prevent breakage during washing and transportation.
- A large bottle neck provides easy filling and pouring. Unique design of the neck prevents drops and spillage.
- Caps are made from polypropylene with large ridges for fast closure.
- Cap inner design with polypropylene washer ensures hermetical and leak-proof closure.
- **Alternative 2 bottles:**
 - Clear bottles
 - Amber bottles
- Amber bottles prevents UV light penetration into the bottle and protects sensitive samples.



clear bottles	amber bottles	volume	neck size	bottle diameter	bottle height	pack quantity
061.10.050	061.11.050	50 ml	32 mm	44 mm	75 mm	10 pieces
061.10.100	061.11.100	100 ml	40 mm	50 mm	93 mm	10 pieces
061.10.250	061.11.250	250 ml	55 mm	70 mm	113 mm	10 pieces
061.10.500	061.11.500	500 ml	55 mm	85 mm	154 mm	10 pieces
061.10.901	061.11.901	1000 ml	68 mm	104 mm	181 mm	10 pieces

BOTTLES - "aluminium"

- These odour-natural, impervious to light and rust proof bottles are manufactured from aluminium.
- Ideal for storing and transporting of samples and products which have to be stored totally unaltered.
- Bottle neck provides easy filling and pouring. Unique design of the neck prevents drops and spillage.
- Caps with large ridges with increased grip featured with self lock and internal security ring. Cap inner design ensures hermetical and leak-proof closure.
- These bottles are supplied with an insert plug for hermetical and leak-proof closure.
- Round neck form allows unrestricted liquid flow out without leaving any residue at the bottle neck.
- 6 lt, 12 lt and 31 lt aluminium bottles are featured with a sturdy handle for easy carrying.



Bottles are supplied with an insert plug for hermetical leak-proof closure.



catalogue number	volume	neck size	bottle diameter	bottle height	pack quantity
061.14.025	25 ml	GL 18	40 mm	80 mm	10 pieces
061.14.060	60 ml	GL 32	45 mm	90 mm	10 pieces
061.14.120	120 ml	GL 32	50 mm	120 mm	10 pieces
061.14.300	300 ml	GL 32	55 mm	165 mm	10 pieces
061.14.600	600 ml	GL 45	75 mm	195 mm	10 pieces
061.14.901	1200 ml	GL 45	90 mm	225 mm	10 pieces
061.14.906	6 L	GL 60	173 mm	335 mm	1 piece
061.14.912	12 L	GL 50	215 mm	430 mm	1 piece
061.14.931	31 L	GL 50	310 mm	500 mm	1 piece



catalogue number	volume	recommended for	neck size	bottle Ø x H	pack quantity
061.47.050	50 ml	for powders	GL 40	50x78 mm	10 pieces
061.47.125	125 ml	for powders	GL 40	55x109 mm	10 pieces
061.47.250	250 ml	for powders	GL 60	69x130 mm	10 pieces
061.47.500	500 ml	for powders	GL 60	82x172 mm	10 pieces
061.47.901	1000 ml	for powders	GL 60	100x210 mm	10 pieces
061.46.901	1000 ml	for liquids	GL 45	100x222 mm	10 pieces
061.46.902	2500 ml	for liquids	GL 45	140x300 mm	10 pieces



item no	catalogue number	volume	neck size	neck O.D	W x L x H (mm)	UN code	pack quantity
1	061.41.500	500 ml	GL 45	45 mm	90 x 90 x 163		50 pieces
2	061.41.901	1000 ml	GL 45	45 mm	95 x 95 x 207		50 pieces
3	061.41.902	2500 ml	GL 45	45 mm	127 x 127 x 310	3H1/Y1,9/150/0517	25 pieces
4	061.41.905	5000 ml	GL 45	45 mm	145 x 145 x 386		25 pieces



Unique design of the cap with inverted top plate guarantees tight and leakproof closure.

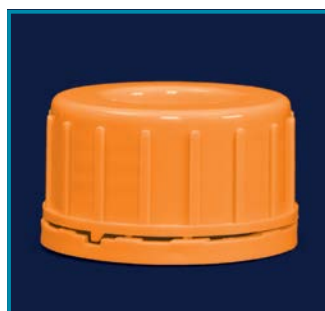

Integral security ring of the cap ensures safe and untouched protection of the bottle content.



Caps are made from robust and thick polyethylene with large ridges for increased grip.



GL 45 caps for liquid bottles are featured with a PTFE protective insert for additional safety.

BOTTLES - "glass"

- Manufactured from neutral glass with thick walls and amber color.
- Amber bottles prevent UV light penetration into the bottle and protect sensitive samples.
- Specially recommended for safe storage and transportation of liquids, powders and pastes.
- Thick wall, heavy base and reinforced rim prevent breakage during washing and transportation.
- Bottle necks provide easy filling and pouring of samples.
- Caps are made from P.E with large ridges for fast closure.
- Cap inner design with inverted top plate ensures hermetical and leak-proof closure. GL 45 caps for liquid bottles are featured with a PTFE protective insert.
- Featured with self lock and internal security ring for safe protection of the bottle content.

BOTTLES - "HDPE" - "for liquids"

- Manufactured from best quality high density polyethylene with thick walls and crush-resistant corners to minimise deformation by vacuum.
- They offer remarkable resistance and durability with highest safety. Wide base avoids the risk of tip over.
- Bottles 2,5 Lt and higher volume are featured with a full hand handle for easier and safe product pouring.
- The large bottle neck provides easy filling and pouring. Unique design of the neck with moulded pouring ring prevents drops and spillage.
- Cap inner design with inverted top plate ensures hermetical and leak-proof closure. **GL 45 caps for liquid bottles are featured with a PTFE protective insert.**
- Featured with self lock and internal security ring for safe protection of the bottle content.

BOTTLES - "HDPE"

➤ Manufactured from best quality high density polyethylene with thick walls and crush-resistant corners to minimise deformation by vacuum.

➤ They offer remarkable resistance and durability with highest safety. Wide base avoids the risk of tip over of the bottle and maximises safety.

➤ These bottles guarantee optimum solutions for safe handling, storage and transport of solid chemicals.

➤ The large bottle neck provides easy filling and pouring. Unique design of the neck with moulded pouring ring prevents spillage.

➤ Cap inner design with inverted top plate ensures hermetical and leak-proof closure.

➤ Featured with self lock and internal security ring for safe protection of the bottle content.



item no	catalogue number	volume	neck size	neck O.D	W x L x H (mm)	UN code	pack quantity
1	061.42.125	125 ml	GL 45	45 mm	60 x 60 x 96		6 pieces
2	061.42.250	250 ml	GL 63	63 mm	86 x 86 x 145		6 pieces
3	061.42.500	500 ml	GL 63	63 mm	90 x 90 x 175		6 pieces
4	061.42.901	1000 ml	GL 63	63 mm	96 x 96 x 207	1H2/Y1,2/S/1118	6 pieces
5	061.42.911	1500 ml	GL 63	63 mm	116 x 116 x 246		6 pieces
6	061.42.902	2500 ml	GL 80	80 mm	127 x 127 x 272		4 pieces



Unique design of the cap with inverted top plate guarantees tight and leakproof closure.



Integral security ring of the cap ensures safe and untouched protection of the bottle content.

BOTTLES - "PET" - "sterile"

➤ Manufactured from special formulated PET with thick walls and crush-resistant corners. Specially recommended for safe storage and transportation of cell culture media.

➤ These bottles are manufactured at aseptically sterile production halls and then send to gamma sterilisation. They can be used for all analysis where a sterile sample is required.

➤ The bottle neck provides easy filling and pouring. Their square shape offers maximum space saving. Caps are made from polyethylene with large ridges for fast closure.

➤ Embossed volume graduations on wall side offer better liquid level viewing.

catalogue number	volume	neck size	bottle W x L x H	pack quantity
061.09.125	125 ml	32 mm	53x53x105 mm	36 pieces
061.09.250	250 ml	32 mm	59x59x147 mm	32 pieces
061.09.500	500 ml	32 mm	77x77x174 mm	32 pieces
061.09.901	1000 ml	32 mm	93x93x214 mm	24 pieces



BOTTLES - "for water sampling" - "polypropylene"



► Manufactured from polypropylene for taking, transporting and storing of water samples for microbiological analysis. They can be used for all analysis where a sterile sample is required.

► Bottles are manufactured at aseptically sterile production halls and then sent to gamma sterilisation. Such informations as lot number, production and expiry dates etc are indicated on the packing.

► Square bottle form offers easy handling and optimum space saving solutions. GL 50 wide bottle neck provides easy filling and pouring.

► Cap with large ridges with increased grip featured with self lock and internal security ring. Cap inner design ensures hermetical and leak-proof closure. Caps are made of polyethylene.

► Embossed volume graduations on wall side offer better liquid level viewing.

► **Alternative 2 bottles:** ► Without sodium thiosulfate
► With sodium thiosulfate

► Bottles with sodium thiosulfate (20 mg/l - according to ISO/FIS 19458/2006 standard) are ideal for water analysis where chlorine may modify the composition of the sample.

► "Bulk packed", where bottles are packed as a group in a box.

► **Alternative 2 packing:** ► "Single packed", where bottles are first individually packed in P.E bags and then repacked in a box.

► **Alternative 2 colors:** ► Clear bottles
► Amber bottles



Self sealing lock caps with integral security ring. Cap inner design ensures hermetical closure and guarantees an excellent leak proof closure.



Each bottle is labelled specifying sample and source descriptions, code and lot numbers, expiry date and other informations.



Cap with large ridges with increased grip featured with self lock and internal security ring. Cap inner design ensures hermetical and leak-proof closure.



► Clear bottles are manufactured from very clear P.P resulting with high transparency and for better view of the bottle content.

► Amber bottles are manufactured from special formulated P.P preventing UV light penetration into the flask yet still offering high transparency.

"Single packed", where bottles are first individually packed in P.E bags and then repacked in a box.

bulk packed bottles	bottle volume	bottle dimensions	clear bottles W/O sodium thiosulfate	clear bottles with sodium thiosulfate	amber bottles W/O sodium thiosulfate	amber bottles with sodium thiosulfate	packing specifications
	125 ml	57 x 57 x 90	061.21.125	061.23.125	061.22.125	061.24.125	180 pcs in box
	250 ml	60 x 60 x 115	061.21.250	061.23.250	061.22.250	061.24.250	108 pcs in box
	500 ml	70 x 70 x 145	061.21.500	061.23.500	061.22.500	061.24.500	84 pcs in box
	1000 ml	90 x 90 x 175	061.21.901	061.23.901	061.22.901	061.24.901	30 pcs in box
single packed bottles	bottle volume	bottle dimensions	clear bottles W/O sodium thiosulfate	clear bottles with sodium thiosulfate	amber bottles W/O sodium thiosulfate	amber bottles with sodium thiosulfate	packing specifications
	125 ml	57 x 57 x 90	061.25.125	061.27.125	061.26.125	061.28.125	130 pcs in box
	250 ml	60 x 60 x 115	061.25.250	061.27.250	061.26.250	061.28.250	72 pcs in box
	500 ml	70 x 70 x 145	061.25.500	061.27.500	061.26.500	061.28.500	42 pcs in box
	1000 ml	90 x 90 x 175	061.25.901	061.27.901	061.26.901	061.28.901	22 pcs in box



CONTAINER CUP

- Manufactured from clear polypropylene with 40 ml effective volume.
- The press-on cap ensures hermetical and leak-proof closure. Scale on side wall for easy volume identification.
- Frosted marking area on side wall enables easy marking and labelling.

catalogue number	product description	pack quantity
087.02.001	non-sterile cups	1000 pieces
087.02.002	aseptic sterile cups	500 pieces



JARS - "glass" - "wide neck"

- Manufactured from neutral glass with thick walls and crush-resistant corners.
- Ideal for safe storage and transportation of liquids and powders.
- Enamaled steel cap inner design ensures hermetical and leak-proof closure.

catalogue number	volume	jar diameter	pack quantity
061.29.040	40 ml	43 mm	10 pieces
061.29.105	105 ml	49 mm	10 pieces
061.29.370	370 ml	72 mm	10 pieces
061.29.720	720 ml	90 mm	10 pieces
061.29.901	1000 ml	95 mm	10 pieces



JARS - "PP" - "wide neck"

- Manufactured from special formulated polypropylene with thick walls and crush-resistant corners.
- Resistant to most acids, bases and many commonly used solvents.
- Ideal for safe storage and transportation of liquids and powders.
- Caps are made from polypropylene with large ridges with increased grip. Cap ensures leak-proof closure.

catalogue number	volume	jar diameter	pack quantity
061.13.001	250 ml	90 mm	1 piece
061.13.002	410 ml	90 mm	1 piece
061.13.004	1270 ml	140 mm	1 piece
061.13.006	1420 ml	140 mm	1 piece
061.13.008	1800 ml	140 mm	1 piece

ICE BUCKETS

- Manufactured from rigid, single-moulded polyurethane with excellent insulation properties.
- Recommended for ice, dry ice and liquid nitrogen involved techniques.
- Guarantees perfect durability needed for chilling temperature sensitive samples.
- Guarantees excellent temperature resistance between -196°C to +90°C.
- Lid with a recessed knob keeps the evaporation at the minimum level.
- Easily stackable due to the tapered body form for reducing storage space.

catalogue number	volume	dimensions (mm)	pack quantity
092.19.001	1 L	210 x 190 x 115	1 piece
092.19.004	4 L	380 x 260 x 150	1 piece





BOTTLES - "spray"

- Manufactured from transparent PET with a spray head.
- All media contacting parts perfectly resist to most solvents and chemicals.
- Liquids can be finely vaporised with the pull of the hand pump trigger.
- Feature with a safety lock at the trigger which prevents accidental use.

catalogue number	volume	pack quantity
062.11.250	250 ml	1 piece
062.11.500	500 ml	1 piece

Extremely fine and homogenous vaporisation is guaranteed with the pull of the trigger.



WASH BOTTLES - "integral"

- Manufactured from highly translucent polyethylene. Ergonomic shape offers easy grip and easy squeeze during use.
- Integral moulded delivery tube delivers the liquid in the bottle until the last drop.
- Delivery tube guarantees a fine and straight flow with an application of a slight pressure on the body.

catalogue number	volume	pack quantity
062.08.250	250 ml	1 piece
062.08.500	500 ml	1 piece



Dispensing tip provides extra fine stream. The tip of the delivery tube can be cut in order to increase the liquid flow rate.



WASH BOTTLES - "narrow neck"

- Manufactured from highly translucent and semi-rigid polyethylene with thick walls and crush-resistant corners.
- Round bottle form allows un-restricted liquid flow-out without leaving any residue at the bottle neck.
- Flexible delivery tube guarantees a fine and straight flow with an application of a slight pressure on the body.
- "Goose neck" design of the delivery tube guarantees easy and precise reaching to the flask corners.
- Dispensing tip provides extra fine stream.
- Delivery tube tip can be cut to increase the flow rate.

Colored body and caps enables fast, and easy identification of bottle content.



clear bottles	volume	coloured bottles	volume	bottle color	pack quantity
062.05.100	100 ml	062.05.05R	500 ml	red	1 piece
062.05.250	250 ml	062.05.05Y	500 ml	yellow	1 piece
062.05.500	500 ml	062.05.05G	500 ml	green	1 piece
062.05.901	1000 ml	062.05.05B	500 ml	blue	1 piece





WASH BOTTLES - "wide neck" - "multi-color cap"

- Manufactured from highly translucent and semi-rigid polyethylene with thick walls and crush-resistant corners.
- Round bottle form allows unrestricted liquid flow out without leaving any residue at the bottle neck.
- Angled delivery tube guarantees a fine and straight flow with an application of a slight pressure on the body.
- Dispensing tube design offers optimum backflow and turbulence free liquid transfer.
- Caps acupled with delivery tube are made from polyethylene with large ridges with increased grip. Cap inner design ensures hermetical and leak-proof closure.



Colored caps enables easy identification of the bottle content. Ribbed cap provides perfect grip.

catalogue number	volume	cap color	pack quantity
062.09.05R	500 ml	red	1 piece
062.09.05Y	500 ml	yellow	1 piece
062.09.05G	500 ml	green	1 piece
062.09.05B	500 ml	blue	1 piece

WASH BOTTLES - "wide neck" - "multilingual"

- Manufactured from highly translucent and semi-rigid polyethylene and polypropylene according to European safety regulations (EC)1272/2008(GHS).
- Angled delivery tube guarantees a fine and straight flow with an application of a slight pressure on the body.
- Dispensing tube design offers turbulence free liquid transfer.
- Caps acupled with delivery tube are made from polyethylene with large ridges with increased grip.
- Cap inner design ensures leak-proof closure.
- Chemical names, formulas, CAS numbers and other key safety informations are printed on the body surface in 4 (English / French / German and Spanish) languages.



Warning words as "flammable", to identify the the hazardous liquids, "how-to-use" instructions in four languages are printed on the body.

Chemical names, formulas, CAS numbers and pictograms showing the latest changes in regulations are printed on the body.

catalogue number	wash bottle label name	bottle material	bottle volume	cap color	pack quantity
062.50.500	acetone	P.P	500 ml	red	1 piece
062.51.500	water	P.E	500 ml	blue	1 piece
062.51.501	distilled water	P.E	500 ml	blue	1 piece
062.51.502	deionised water	P.E	500 ml	blue	1 piece
062.52.500	ethanol	P.E	500 ml	green	1 piece
062.53.500	ethyl acetate	P.E	500 ml	white	1 piece
062.54.500	iso-propanol	P.E	500 ml	yellow	1 piece
062.55.500	methanol	P.E	500 ml	orange	1 piece
062.56.500	methylethylketone	P.P	500 ml	brown	1 piece
062.57.500	tetrahydrofuran	P.P	500 ml	black	1 piece
062.58.500	toluene	P.E	500 ml	torquise	1 piece



JERRYCANS - "polyethylene"

- Manufactured from UV stabilised, thick polyethylene with sturdy carrying handles.
- Featured with a wide neck for easy filling and draining.
- Caps are made from polypropylene with large ridges with increased grip.
- Cap with self-locking internal security ring ensures leak-proof closure.
- 20 and 30 lt jerrycans are featured with a leak-proof stopcock which prevents vacuum formation during draining.



Caps are made from polypropylene with large ridges for increased grip.

catalogue number	volume	pack quantity
062.21.902	2 L	1 piece
062.21.903	3 L	1 piece
062.21.905	5 L	1 piece
062.21.910	10 L	1 piece
062.21.920	20 L	1 piece
062.21.930	30 L	1 piece



CARBOYS - "aspirator bottles" - "with stopcock" - "polypropylene"

- Manufactured from UV stabilised, thick polypropylene with sturdy carrying handles.
- Featured with a wide neck for easy filling and draining.
- Caps are made from polypropylene with large ridges with increased grip. Cap ensures leak-proof closure.
- Featured with a leak-proof stopcock.



Caps are made from polypropylene with large ridges with increased grip.



Featured with a leak-proof stopcock which prevents vacuum formation during draining.

catalogue number	volume	carboy Ø	carboy H	cap Ø	pack quantity
062.28.905	5 L	170 mm	345 mm	55 mm	1 piece
062.28.910	10 L	200 mm	455 mm	55 mm	1 piece
062.28.920	20 L	265 mm	550 mm	55 mm	1 piece



BOTTLES - "aspirator" - "with stopcock" - "glass"

- Manufactured from heat resistant, durable borosilicate glass with thick wall, heavy base and reinforced rim.
- Featured with a wide neck for easy filling and draining.
- Caps are made from polypropylene with large ridges with increased grip.
- Cap inner design ensures leak-proof closure.
- Featured with a leak-proof stopcock.



Caps are made from polypropylene with large ridges with increased grip.



Featured with a leak-proof stopcock which prevents vacuum formation during draining.

catalogue number	volume	pack quantity
062.27.905	5 L	1 piece
062.27.910	10 L	1 piece
062.27.920	20 L	1 piece

BOTTLES - "dropping"



➤ Manufactured from transparent polyethylene with a dropping cap. Cap can be easily dismantled for cleaning.

➤ Dispensing tip provides similar size drops at all times. Supplied with a push-to-open cap for safety reasons.

catalogue number	volume	pack quantity
062.10.010	10 ml	10 pieces
062.10.015	15 ml	10 pieces
062.10.020	20 ml	10 pieces
062.10.030	30 ml	10 pieces



BOTTLES - "dropping"



➤ Manufactured from heat resistant, durable borosilicate glass with a glass dropping cap.

➤ Dispensing tip provides similar size drops at all times.

➤ Amber bottles prevent UV lights to penetrate into the bottle.

clear bottles	amber bottles	volume	pack quantity
062.02.100	062.03.100	100 ml	1 piece



BOTTLES - "dropping"



➤ Manufactured from heat resistant, durable borosilicate glass with a rubber dropping cap. Cap can be easily dismantled for cleaning.

➤ Dispensing tip provides similar size drops at all times.

➤ Amber bottles prevent UV lights to penetrate into the bottle.

clear bottles	amber bottles	volume	pack quantity
062.12.050	062.13.050	50 ml	1 piece
062.12.100	062.13.100	100 ml	1 piece



BOTTLES - "dropping"



➤ Manufactured from transparent polyethylene with a dropping cap. Cap can be easily dismantled for cleaning.

➤ Dispensing tip provides similar size drops at all times. The dispensing tip can be cut to increase the drop volume

➤ Amber bottles prevent UV lights to penetrate into the bottle.

clear bottles	amber bottles	volume	pack quantity
062.04.100	062.04.101	100 ml	1 piece



CARRIERS - "for bottles"

- Manufactured from epoxy coated steel wire for safe transportation of 500 ml, 1 lt and 2,5 lt standard chemical bottles.
- Easy to grab sturdy handle offers perfect balance and comfort during use.

catalogue number	for bottle max. dia.	bottle array	pack quantity
062.66.500	100 mm	6 x 500 ml	1 piece
062.66.901	105 mm	4 x 1000 ml	1 piece
062.66.902	140 mm	2 x 2500 ml	1 piece



BASKET - "for bottles"

- Manufactured from ABS for safe and convenient transportation up to 6 wash bottles.
- Although highly recommended for 500 ml bottles can also carry 250 ml bottles.
- Strong, light weight body construction and ergonomic handle offer both comfort and control.
- Easily stackable due to the tapered body form for reducing storage space.

catalogue number	for bottle max. diameter	pack quantity
062.66.001	90 mm	1 piece



TRANSPORT BOX

- Manufactured from polypropylene for storing and transporting small size products.
- Clasp lid ensures safe closure and guarantees the interior being not effected by dust, humidity and other enviromental conditions.
- The clarity of the box enables the user to visibly check the sample integrity and use the box safely.
- Carry handle folds neatly allowing the boxes can be stacked on each other.
- The lid can open fully 180° offering easy access to the contents and easy cleaning of interior.

catalogue number	pack quantity
062.66.004	1 piece

BOX - "with compartments" - "acrylic"



- Manufactured from acrylic featured with different size compartments.
- Offers practical positioning of different size small objects such as magnetic stirrers.
- The long compartment is ideal to store longer objects including magnetic bar retrievers.
- Featured with a lid protecting the box interior.

catalogue number	box width	box length	box height	compartment quantity	pack quantity
057.02.101	330 mm	110 mm	35 mm	12	1 piece

DISPENSER BOXES



➤ Manufactured from crystal clear acrylic with excellent field of vision.

➤ Ideal assistants for storing and dispensing small sized products such as pipette tips, tubes, vials and many others.

➤ Generous openings provide easy and safe access to partiations.

➤ Covers are featured with easy opening hinged lids. Once opened, the lid stands open and enables easy handling.

➤ Their flip-top covers guarantee safe and clean storage without been effected from enviromental effects.

➤ Featured with non-skid silicone feet for safe and stable stand on the desks.

catalogue number	specifications	external dimensions	pack quantity
006.15.001	1 compartment	175 x 250 x 330 mm	1 piece
006.15.002	2 compartments	175 x 250 x 330 mm	1 piece
006.15.003	3 compartments	265 x 250 x 330 mm	1 piece



BOXES - "double opening"

➤ Manufactured from polypropylene for storing and transporting all products including food stuff.

➤ Clasping lid ensures safe closure and guarantees the interior being not effected by dust, humidity and other enviromental conditions.

➤ The clarity of the box enables the user to visibly check the sample integrity and safe use of the box safely.

➤ Easily stackable due to the tapered body form for reducing storage space.

➤ The lid can open fully 180° with two steps offering easy access to the contents and easy cleaning of interior.



catalogue number	dimensions (mm)	box volume	pack quantity
062.39.900	95 x 150 x 75	0,75 L	1 piece
062.39.901	125 x 185 x 65	1,00 L	1 piece
062.39.902	125 x 185 x 90	1,50 L	1 piece
062.39.903	155 x 230 x 110	3,00 L	1 piece
062.39.905	200 x 280 x 125	5,00 L	1 piece
062.39.907	255 x 355 x 122	7,50 L	1 piece
062.39.910	250 x 345 x 150	10,00 L	1 piece
062.39.913	255 x 355 x 200	13,00 L	1 piece



BOXES - "click lock lid"

➤ Manufactured from polypropylene for easy and safe storage of most products.

➤ "Click-lock" system enables safe closure and easy opening of the box lid.

➤ The clarity of the box enables the user to visibly check the sample integrity and safe use of the box.

➤ Easily stackable due to the tapered body form for reducing storage space.

catalogue number	dimensions (mm)	box volume	pack quantity
062.36.910	385 x 260 x 155	10 L	1 piece
062.36.920	460 x 320 x 180	20 L	1 piece
062.36.930	510 x 355 x 230	30 L	1 piece



TEST TUBES - "glass"

- Manufactured by automated machines with consistent length and thickness.
- Due to the properties of borosilicate glass highly recommended for over heated applications.

tube dimensions	neutral glass test tubes	borosilicate glass tubes	pack quantity
6 x 40 mm	077.01.000		100 pieces
10x75 mm	077.01.001	077.02.001	100 pieces
12x75 mm	077.01.021		100 pieces
12x100 mm	077.01.002	077.02.002	100 pieces
13x100 mm	077.01.003	077.02.003	100 pieces
13x130 mm	077.01.031		100 pieces
16x100 mm	077.01.004	077.02.004	100 pieces
16x160 mm	077.01.005	077.02.005	100 pieces
18x180 mm	077.01.006	077.02.006	100 pieces
20x200 mm	077.01.007		100 pieces
20x220 mm	077.01.008		100 pieces

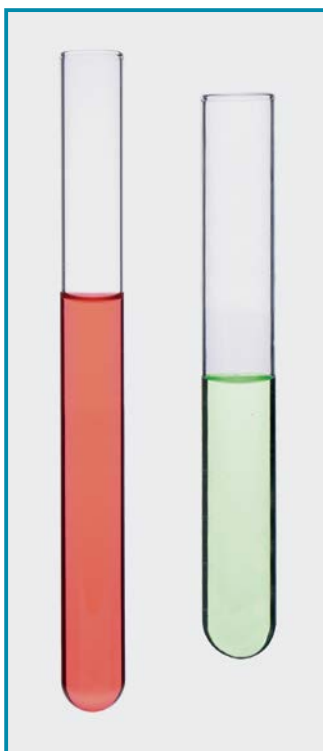

TEST TUBES - "P.P or P.S"

- Manufactured from clear polypropylene or from polystyrene for disposable use.

PS tubes	PP tubes	tube dimensions	bottom form	pack quantity
077.04.001	077.04.002	12x75 mm	round	1000 pieces
077.04.003	077.04.004	16x100 mm	round	500 pieces
077.04.005	077.04.006	16x100 mm	conical	500 pieces



TEST TUBES "glass" - "with screw cap"

- Manufactured from neutral glass featured with a polypropylene screw cap.
- Hermetic caps guarantee absolute leak-proof closure.
- Specially recommended for tissue culture or other similar applications.
- Tubes and caps are delivered in separate packings.

catalogue number	tube dimensions	pack quantity
077.03.001	16x100 mm	100 pieces
077.03.002	16x160 mm	100 pieces

CENTRIFUGE TUBES - "glass"

- Manufactured from neutral glass with wall thickness 1,0 - 1,1 mm.
- Nominal capacity is approximately 15 ml. They stand up to 3.500 RCF and guarantee problem free centrifugation.

tube centrifuge	tube dimensions	product specifications	pack quantity
078.01.001	16x100 mm	non-graduated	100 pieces
078.01.002	16x100 mm	graduated	10 pieces

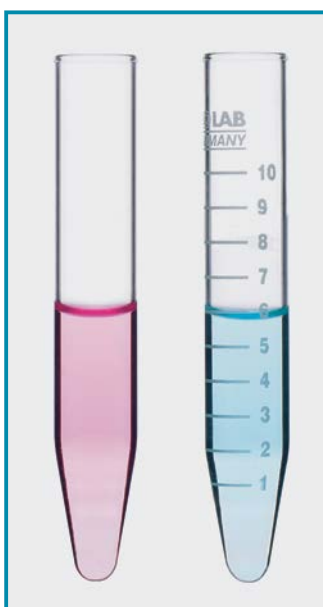

Various beaker tongs can be selected from catalogue page no 69.

TUBE RACKS - "epoxy coated steel"

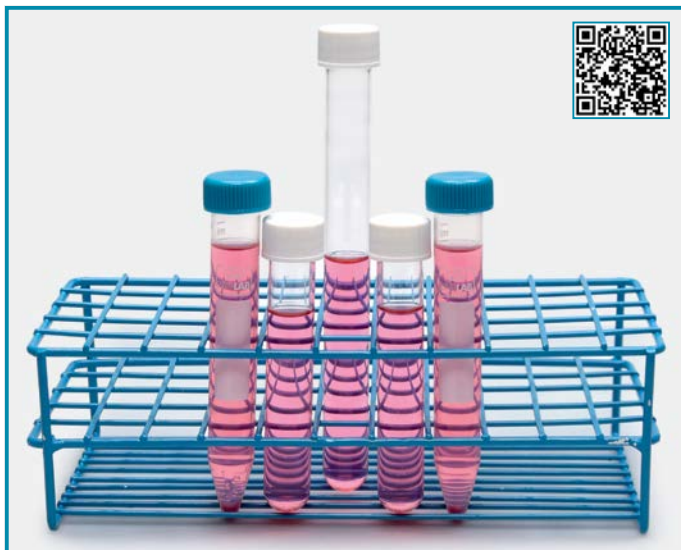

- They offer ideal solutions with square tube holes, reinforced edges and slotted bottom design for secure handling.
- Manufactured from high quality steel wire, welded and coated with heat cured blue epoxy.
- The epoxy coating is absolutely corrosion proof and can resist to salts, moderate acids, moderate alkalis and organic solvents.
- Ideal for autoclaving. Can resist from -200°C to +121°C.

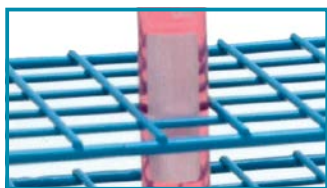

Square tube holes and slotted bottom design guarantees firm hold of the tubes at exact positions.

catalogue number	for tubes	well quantity	tube array	rack L x W x H	pack quantity
079.01.101	13 mm	84	6 x 14	100x231x68 mm	1 piece
079.01.102	16 mm	55	5 x 11	118x260x74 mm	1 piece
079.01.103	18 mm	55	5 x 11	110x235x75 mm	1 piece
079.01.104	20 mm	40	4 x 10	100x235x70 mm	1 piece
079.01.105	25 mm	32	4 x 8	116x230x93 mm	1 piece
079.01.106	30 mm	21	3 x 7	110x260x95 mm	1 piece

TUBE RACKS - "with silicone grips"



- Manufactured from modified ABS which enables the racks to be used in water baths without floating.
- Bottom of each tube compartment is featured with a silicone grip that firmly holds the tubes in position without wobble.
- Tubes can be inserted and extracted with a gentle push or pull.

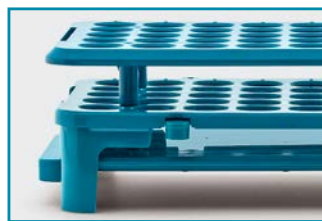

PUSH & EJECT function

Just simply press upwards the bottom layer of the tube rack by two hands. The eject mechanism automatically releases the tubes from their positions simultaneously and immediately.



SILICONE GRIP function

Bottom of each tube compartment is featured with a silicone grip that firmly holds the tubes in position without wobble.

catalogue number	tube diameter	tube qty	tube array	pack quantity
079.11.016	15/16 mm	50	5x10	1 piece

TUBE RACKS - "st. steel"



- Manufactured from high quality, chemical and corrosion resistant AISI 304 grade stainless steel.
- Robust and seamless construction guarantees long life cycle. Smooth polished surface provides fast and easy cleaning.
- Offers a very long life cycle due to the very robust construction.
- Perfect design of the tube holes firmly keeps the tubes at their position.

catalogue number	tube diameter	tube quantity	tube array	pack quantity
079.02.001	13 mm	50	5x10	1 piece
079.02.002	16 mm	50	5x10	1 piece
079.02.003	18 mm	40	4x10	1 piece

TUBE RACKS - "polypropylene" - "dismantled"



➤ Manufactured from modified polypropylene which enables the racks to be used in water baths without floating.

➤ Guarantees temperature resistance between -20°C to +121°C.

➤ 4 different color options offer visual sorting and organising of different samples.

➤ The alpha numeric grid reference on the top tier of the rack ensures an easy tube location and sample positioning.

➤ Racks are supplied dismantled for reducing storage area.

➤ Racks can be easily assembled less than half a minute with the help of supplied instruction manual.

item no	for tubes	well quantity	tube array	rack L x W x H	white racks catalogue no	blue racks catalogue no	red racks catalogue no	orange racks catalogue no	pack quantity
1	13 mm	84	6 x 14	125x265x70 mm	079.01.001W	079.01.001B	079.01.001R	079.01.001O	1 piece
2	16 mm	55	5 x 11	125x265x70 mm	079.01.002W	079.01.002B	079.01.002R	079.01.002O	1 piece
3	18 mm	55	5 x 11	125x265x70 mm	079.01.003W	079.01.003B	079.01.003R	079.01.003O	1 piece
4	20 mm	40	4 x 10	125x265x70 mm	079.01.004W	079.01.004B	079.01.004R	079.01.004O	1 piece
5	25 mm	32	4 x 8	125x265x90 mm	079.01.005W	079.01.005B	079.01.005R	079.01.005O	1 piece
6	30 mm	21	3 x 7	125x265x90 mm	079.01.006W	079.01.006B	079.01.006R	079.01.006O	1 piece

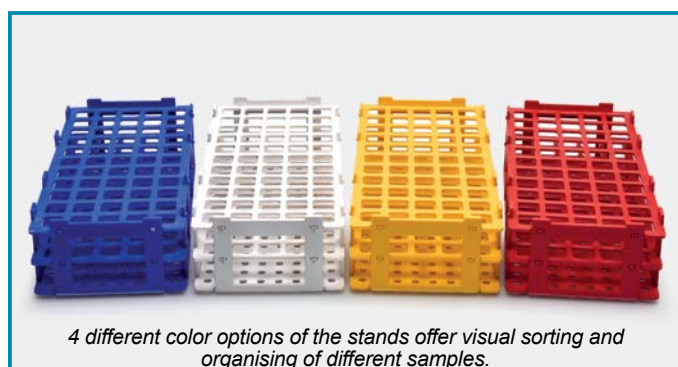
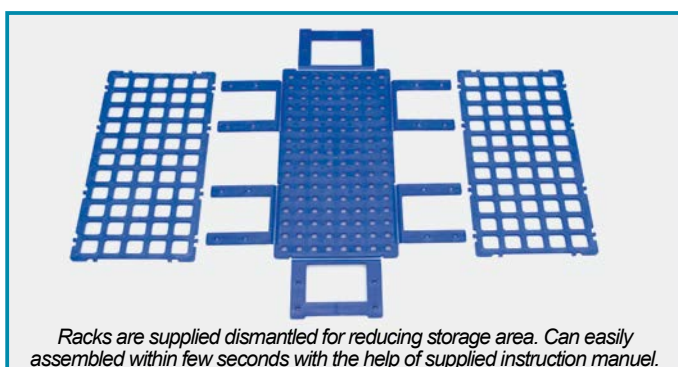

TUBE RACK - "4 sides"

➤ Manufactured from modified polypropylene which enables the racks to be used in water baths without floating.

- 4 sides offer 4 different tube holding alternative.
- Side 1: holds 4 x 30 mm dia. tube with 2 x 2 array
 - Side 2: holds 32 x 12 mm dia. tube with 4 x 8 array
 - Side 3: holds 12 x 17 mm dia. tube with 2 x 6 array
 - Side 4: holds 96 x 7 mm dia. tube with 8 x 12 array

➤ Racks are designed with an interlocking system for connection to each other in order to form multi rack rows.

➤ Alphanumeric index on tube rows enables easy identification of tube positions.

catalogue number	tube diameter	tube volume	tube quantity	tube array	pack quantity
080.01.001	30 mm	50 ml	4	2 x 2	1 piece
	12 mm		32	4 x 8	
	17 mm	15 ml	12	2 x 6	
	7 mm		96	8 x 12	



TUBE RACKS - "polypropylene" - "foldable"



- Manufactured from modified polypropylene which enables the racks to be used in water baths without floating.
- Guarantees temperature resistance between -20°C to +121°C.
- 4 different color options offer visual sorting and organising of different samples.
- Raised tube sockets guarantee firm hold of the tubes at their exact positions.
- The alpha numeric grid reference on the top tier of the rack ensures an easy tube location and sample positioning.
- Racks are supplied assembled and folded. Can be ready for use in few seconds with a simple action.
- These racks can be folded after use for reducing storage area.

for tubes	well quantity	tube array	rack L x W x H	white racks catalogue no	blue racks catalogue no	red racks catalogue no	orange racks catalogue no	pack quantity
13 mm	50	5 x 10	160x275x70 mm	079.03.001W	079.03.001B	079.03.001R	079.03.001O	1 piece
16 mm	50	5 x 10	160x275x70 mm	079.03.002W	079.03.002B	079.03.002R	079.03.002O	1 piece
18 mm	50	5 x 10	160x275x70 mm	079.03.003W	079.03.003B	079.03.003R	079.03.003O	1 piece
20 mm	45	5 x 9	160x275x70 mm	079.03.004W	079.03.004B	079.03.004R	079.03.004O	1 piece
30 mm	26	4 x 6/7	160x275x70 mm	079.03.005W	079.03.005B	079.03.005R	079.03.005O	1 piece

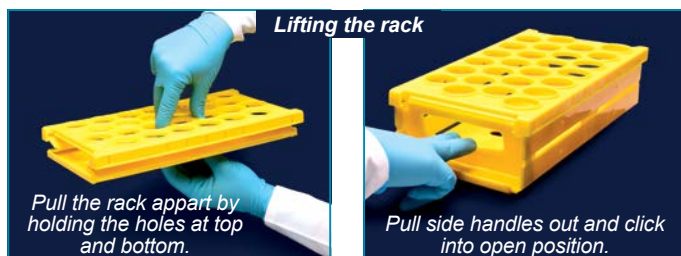



STANDS - "rectangular"

- Highly stable rectangular base is manufactured from enamel coated sheet steel.
- Silicone feet placed under the base prevents the stand from sliding.
- Supplied without rods. Kindly select the suitable rod from below table.

catalogue number	dimensions	pack quantity
049.01.130	130 x 210 mm	1 piece
049.01.150	150 x 300 mm	1 piece
049.01.200	200 x 315 mm	1 piece

SUPPORT RODS

- Manufactured either from galvanised steel or stainless steel with a M10 thread.

galvanised steel	rod length	rod diameter	pack quantity
049.06.004	600 mm	12 mm	1 piece
049.06.005	750 mm	12 mm	1 piece
049.06.006	1000 mm	12 mm	1 piece

stainless steel	rod length	rod diameter	pack quantity
049.07.004	600 mm	12 mm	1 piece
049.07.005	750 mm	12 mm	1 piece
049.07.006	1000 mm	12 mm	1 piece

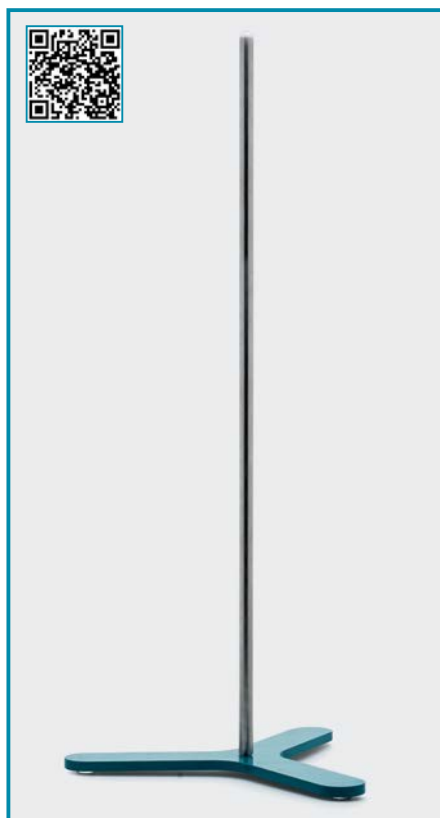

STANDS - "triangle"

- Highly stable triangle base is manufactured from enamel coated sheet steel.
- Silicone feet placed under the base prevents the stand from sliding.
- Supplied without rods. Kindly select the suitable rod from below table.

catalogue number	foot length	base thickness	pack quantity
049.03.115	115 mm	8 mm	1 piece
049.03.150	150 mm	8 mm	1 piece

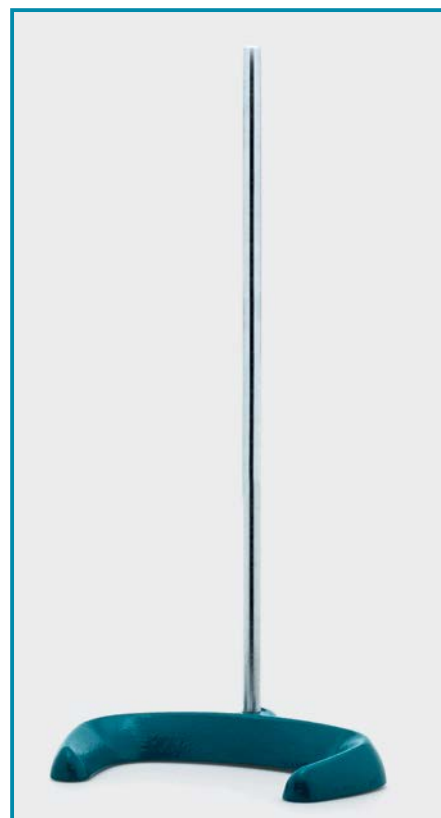

STANDS - "horse shoe"

- The most sturdy stand type.
- Extremely stable horse shoe base is manufactured from enamel coated cast steel.
- Highly recommended for various applications such as titration, assembly of stirrers etc. Supplied with rods.

catalogue number	size	rod dia.	rod height	pack quantity
049.09.180	small	12 mm	600 mm	1 piece
049.09.250	medium	14 mm	700 mm	1 piece
049.09.320	large	16 mm	800 mm	1 piece



WIRE GAUZES

- Manufactured from galvanised steel with a ceramic circular plate at the center.

catalogue number	wire gauze dimensions	pack quantity
050.06.001	150x150 mm	1 piece

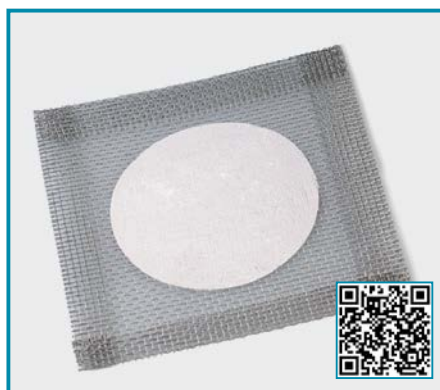



STANDS - "ABS"

- Highly stable rectangular base is manufactured from ABS.
- Base with dimensions 175x300 mm has two rod holding holes.
- Same rod can be placed either at the center or at the rear of the base offering multi advantages.
- White base color guarantees perfect visual observation of color changes during titration applications.
- Delivered complete with a screw-in galvanized support rod of 600 mm height.

catalogue number	base width	base length	pack quantity
049.04.175	175 mm	300 mm	1 piece



LABORATORY JACKS

- Table and base plate are manufactured from anodized aluminium. Scissors are made from stainless steel.
- Large control knob enables smooth and continuous control of table height.

catalogue number	plate width	plate length	pack quantity
050.05.150	150 mm	150 mm	1 piece
050.05.200	200 mm	200 mm	1 piece



TRIPOD - "fix height"

- Manufactured from chrome plated steel.
- Holding ring with 125 mm diameter offers practical use with all sizes of ceramic triangles and wire gauzes.

catalogue number	fix height	pack quantity
050.04.001	200 mm	1 piece



150 mm standard diameter of circular ring can be reduced to 125 mm with the help of supplied reduction ring.

TRIPOD - "adjustable height"

- Manufactured from chrome plated steel. Height can be adjustable from 200 mm to 300 mm.
- Holding ring with 150 mm diameter can be reduced to 125 mm with the supplied reduction attachment.

catalogue number	pack quantity
050.04.002	1 piece

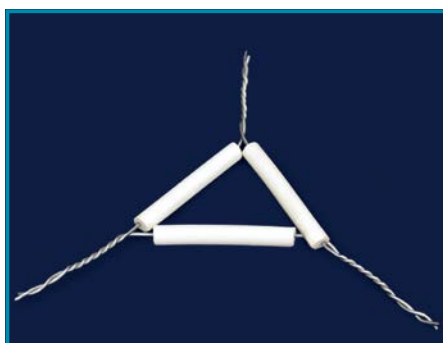

CERAMIC TRIANGLES

- Consists of ceramic pipes around galvanized steel wire.

catalogue number	ceramic cylinder dimension	pack quantity
050.07.050	50 mm	1 piece
050.07.060	60 mm	1 piece



CLAMP - "2 jaws" - "without bosshead"

➤ Manufactured from high quality, corrosion resistant chromated steel holding for various objects in the most secure way.

➤ PVC coated insulated jaws guarantee perfect heat insulation. Soft and elastic coating holds the glassware gently and prevent possible breakage.

➤ Individually adjustable clamps guarantee perfect and precise control of holding pressure and holding position.

➤ Clamps can be opened and closed smoothly with a 50 mm grip diameter.

catalogue number	pack quantity
045.01.001	1 piece



CLAMP - "2 jaws" - "with bosshead"

➤ Manufactured from high quality, corrosion resistant chromated steel holding for various objects in the most secure way.

➤ Featured with a swivel bosshead which provides 360° swivel of the clamped object around their axis. Bosshead locking feature guarantees perfect position hold of the clamped objects. Adjustable clamps guarantee perfect pressure control.

➤ PVC coated insulated jaws guarantee perfect heat insulation. Soft coating holds the glassware gently and prevent breakage.

➤ Clamps can be opened and closed smoothly with a 50 mm grip diameter.

catalogue number	pack quantity
045.04.001	1 piece



CLAMP - "3 jaws" - "without bosshead"

➤ Manufactured from high quality, corrosion resistant chromated steel holding for various objects in the most secure way.

➤ PVC coated insulated jaws guarantee perfect heat insulation. Soft and elastic coating holds the glassware gently and prevent possible breakage.

➤ Individually adjustable clamps guarantee perfect and precise control of holding pressure and holding position.

➤ Clamps can be opened and closed smoothly with a 70 mm grip diameter.

catalogue number	pack quantity
045.03.001	1 piece



CLAMP - "3 jaws" - "with bosshead"

➤ Manufactured from high quality, corrosion resistant chromated steel holding for various objects in the most secure way.

➤ Featured with a swivel bosshead which provides 360° swivel of the clamped object around their axis. Bosshead locking feature guarantees perfect position hold of the clamped objects. Adjustable clamps guarantee perfect pressure control.

➤ PVC coated insulated jaws guarantee perfect heat insulation. Soft coating holds the glassware gently and prevent breakage.

➤ Clamps can be opened and closed smoothly with a 70 mm grip diameter.

catalogue number	pack quantity
045.06.001	1 piece



CLAMP - "for frame work"

➤ Manufactured from high quality, corrosion resistant chromated steel.

➤ Ideal for frame works and fixing perpendiculars.

➤ Clamps can be opened and closed smoothly by a screw thread with a 12 mm grip diameter.

catalogue number	pack quantity
046.07.001	1 piece



CLAMP - "for thermometers"

- Manufactured from high quality, corrosion resistant chromated steel for holding thermometers in the most secure way.
- Featured with a swivel bosshead which provides 360° swivel of the clamped object around their axis.
- Bosshead locking feature guarantees perfect position hold of the clamped objects.
- Fixing head featured with flexible springs offers easy insertion and extraction of the thermometers.
- Clamps can be opened and closed smoothly with a 30 mm grip diameter.

catalogue number	pack quantity
060.04.001	1 piece



BOSSEHEAD - "standard" - "fix position"

- Manufactured from high quality, corrosion resistant chromated steel for holding rods in the most secure way.
- Holds the objects on a fixed position.
- Clamps can be opened and closed smoothly with a 20 mm grip diameter.

catalogue number	pack quantity
046.01.001	1 piece



BOSSEHEAD - "heavy duty" - "fix position"

- Manufactured from high quality, corrosion resistant chromated steel for holding rods in the most secure way.
- Holds the objects on a fixed position.
- Clamps can be opened and closed smoothly with a 15 mm grip diameter.

catalogue number	pack quantity
046.05.001	1 piece



BOSSEHEAD - "heavy duty" - "fix position"

- Manufactured from high quality, corrosion resistant powder coated steel for holding rods in the most secure way.
- Holds the objects on a fixed position.
- Sturdy construction guarantees the use with heavy objects.
- Clamps can be opened and closed smoothly with a 30 mm grip diameter.

catalogue number	pack quantity
046.05.002	1 piece



BOSSEHEAD - "standard" - "swivel head"

- Manufactured from high quality, corrosion resistant chromated steel for holding rods in the most secure way.
- Featured with a swivel bosshead which provides 360° swivel of the clamped object around their axis.
- Bosshead locking feature guarantees perfect position hold of the clamped objects.
- Clamps can be opened and closed smoothly with a 20 mm grip diameter.

catalogue number	pack quantity
046.01.002	1 piece

lab consumables & labware



TONGS - "rod jaws"

- Manufactured from high quality, corrosion resistant chromated steel for holding erlenmeyers and flasks in the most secure way.
- Soft and elastic coating holds the glassware gently and prevent possible breakage.

- PVC coated insulated jaws guarantees perfect heat insulation.

catalogue number	pos. no	pack quantity
029.03.001	1	1 piece
026.03.001	2	1 piece

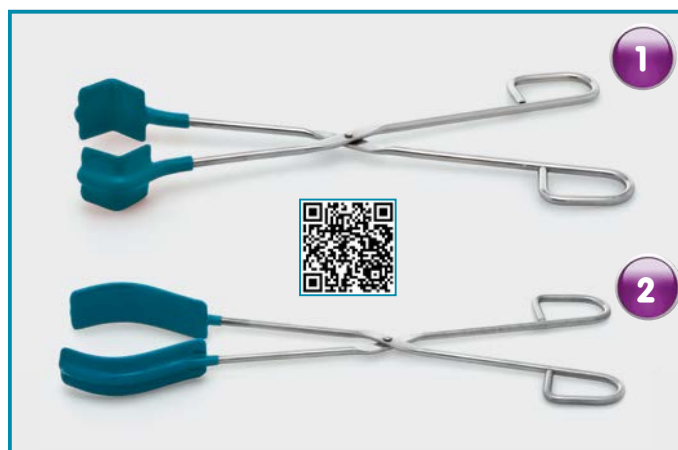

TONGS - "flat jaws"

- Manufactured from high quality, corrosion resistant chromated steel for holding erlenmeyers and flasks in the most secure way.
- Soft and elastic coating holds the glassware gently and prevent possible breakage.

- PVC coated insulated jaws guarantees perfect heat insulation.

catalogue number	pos. no	pack quantity
029.03.002	1	1 piece
026.03.002	2	1 piece



TONGS - "for evaporating dishes"

- Manufactured from high quality, chromated steel.

- Unique design with grabbing jaws enables safe holding of dishes.

catalogue number	total length	pack quantity
038.05.001	280 mm	1 piece



TONGS - "for crucibles"

- Manufactured from high quality, chromated steel for holding crucibles.

- Unique design with grabbing jaws enables safe holding of crucibles.

catalogue number	total length	pack quantity
038.06.250	250 mm	1 piece
038.06.300	300 mm	1 piece
038.06.400	400 mm	1 piece

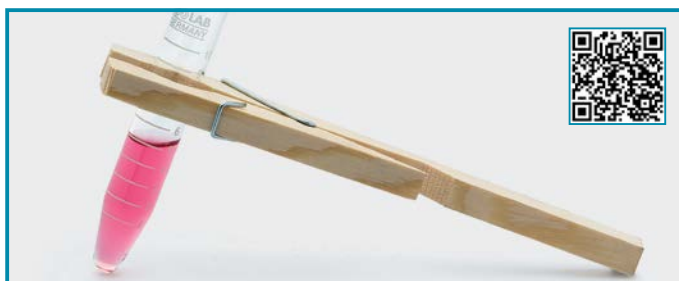

CLAMP - "for tubes" - "wood"

- Manufactured from hardened wood for holding tubes in the most secure way.

- Featured with a steel spring for tight and firm holding of the tubes.

catalogue number	total length	pack quantity
080.04.001	180 mm	1 piece



CLAMP - "for tubes" - "steel"

- Manufactured from chromated steel for holding tubes in the most secure way.

- Featured with a steel spring and a finger for tight and firm holding of the tubes.

catalogue number	total length	pack quantity
080.04.002	150 mm	1 piece



SPATULAS - "st. steel" - "macro spoon"

➤ Manufactured from AISI 304 grade stainless steel. Most commonly used spatula.

➤ Featured with a macro spoon for medium and large size particles at one end and a straight/flat spatula at the other end.

catalogue number	total length	pack quantity
047.01.120	120 mm	1 piece
047.01.150	150 mm	1 piece
047.01.180	180 mm	1 piece
047.01.210	210 mm	1 piece
047.01.250	250 mm	1 piece
047.01.300	300 mm	1 piece

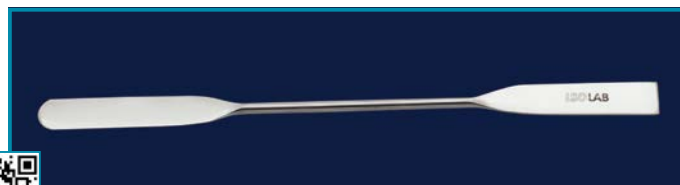

SPATULAS - "st. steel" - "double end"

➤ Manufactured from AISI 304 grade stainless steel. Suitable for transferring products from flat or sticky surfaces.

➤ Featured with a round/flat spatula at one end and a straight/flat spatula at the other end.

catalogue number	total length	pack quantity
047.07.130	130 mm	1 piece
047.07.150	155 mm	1 piece
047.07.185	180 mm	1 piece
047.07.210	210 mm	1 piece
047.07.250	255 mm	1 piece
047.07.300	300 mm	1 piece

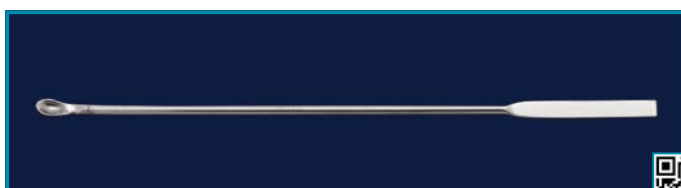

SPATULAS - "st. steel" - "micro spoon"

➤ Manufactured from AISI 304 grade stainless steel. Featured with a micro spoon for small size particles at one end and a straight/flat spatula at the other end.

catalogue number	total length	pack quantity
047.06.150	150 mm	1 piece
047.06.180	180 mm	1 piece
047.06.210	210 mm	1 piece

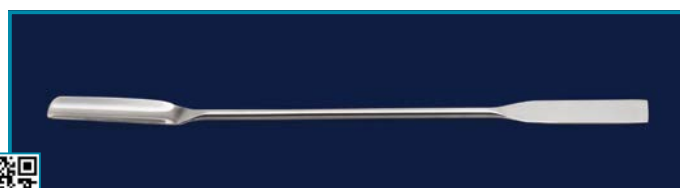

SPATULAS - "st. steel" - "round grooved"

➤ Manufactured from AISI 304 grade stainless steel. Featured with a grooved spoon at one end and a straight/flat spatula at the other end.

catalogue number	total length	pack quantity
047.02.150	150 mm	1 piece
047.02.180	185 mm	1 piece
047.02.210	210 mm	1 piece



SPATULAS - "st. steel" - "curved end"

➤ Manufactured from AISI 304 grade stainless steel. Featured with a curved/flat spatula at one end and a curved /flat spatula at the other end.

catalogue number	total length	pack quantity
047.03.150	150 mm	1 piece
047.03.180	180 mm	1 piece
047.03.210	210 mm	1 piece



SPATULAS - "st. steel" - "poly"

➤ Manufactured from AISI 304 grade stainless steel. Featured with a ellipsoidal/curved spoon at one end and a straight/flat triangular spatula at the other end.

catalogue number	total length	pack quantity
047.08.150	150 mm	1 piece
047.08.180	180 mm	1 piece
047.08.210	210 mm	1 piece



SPATULAS - "st. steel" - "chattaway"

➤ Manufactured from AISI 304 grade stainless steel. Suitable for transferring products from flat or sticky surfaces. Featured with a curved/flat spatula at one end and a straight/flat spatula at the other end.

catalogue number	total length	pack quantity
047.09.100	100 mm	1 piece
047.09.130	130 mm	1 piece
047.09.150	150 mm	1 piece
047.09.180	180 mm	1 piece
047.09.210	210 mm	1 piece



SPATULAS - "st. steel" - "flat knife"

➤ Manufactured from AISI 304 grade stainless steel with a wooden handle. Suitable for large size transferring products. Featured with a flat knife formed spatula at one end and a wooden handle at the other end.

catalogue number	knife length	pack quantity
047.10.075	75 mm	1 piece
047.10.100	100 mm	1 piece
047.10.150	150 mm	1 piece
047.10.200	200 mm	1 piece
047.10.300	300 mm	1 piece

lab consumables & labware

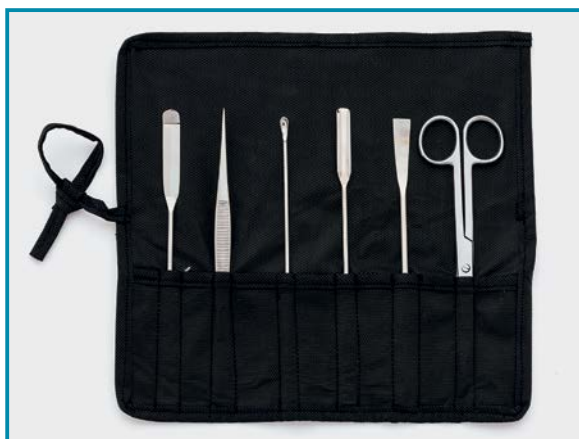

SPATULAS - "in a wallet"

➤ A practical set of 6 most common and frequently used spatulas all manufactured from high quality, chemical and corrosion resistant AISI 304 grade stainless steel .

➤ Set consists of one of each micro spoon / curved and ground/ chattaway spatula with all 180 mm length and dissecting forcep / blunt - sharp scissors with 160 mm length.

➤ All spatulas are placed into suitable holding pockets of the wallet that keeps the spatulas away from disorder and exterior effects.

spatula set	pack quantity
047.05.001	1 piece

empty wallet	pack quantity
047.05.002	1 piece

SCOOPS - "polypropylene" - "self standing"



➤ Manufactured from high quality polypropylene which resists to most acids, bases and many commonly used solvents.

➤ Guarantees excellent temperature resistance between -20°C to +121°C.

➤ Perfect shape and size enable efficient sampling of various powder, granulate and paste form samples.

➤ 9 volume sizes from 2 ml to 1000 ml offer a wide sampling option from smallest to largest sample volume.

➤ Due to their flat bottom construction these scoops can stand horizontal on the flat surfaces and can also be used as a weighing pan.

➤ With the help of precision formed sharp edge they offer best performance while picking up samples even from wet surfaces.



Featured with easy to grip handles for comfortable use. Approximate volume values are printed on the handles.

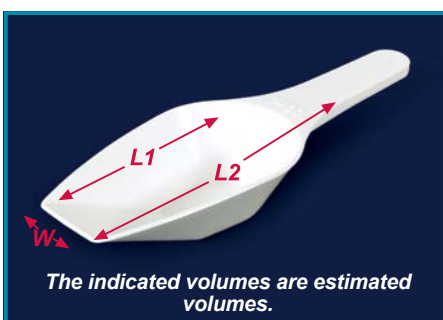

white scoops	blue scoops	volume	L1	L2	W	pack quantity
037.30.002W	037.30.002B	2 ml	31 mm	62 mm	10 mm	1 piece
037.30.005W	037.30.005B	5 ml	42 mm	82 mm	13 mm	1 piece
037.30.010W	037.30.010B	10 ml	56 mm	96 mm	16 mm	1 piece
037.30.025W	037.30.025B	25 ml	74 mm	128 mm	21 mm	1 piece
037.30.050W	037.30.050B	50 ml	92 mm	164 mm	27 mm	1 piece
037.30.100W	037.30.100B	100 ml	118 mm	203 mm	34 mm	1 piece
037.30.250W	037.30.250B	250 ml	153 mm	263 mm	44 mm	1 piece
037.30.500W	037.30.500B	500 ml	195 mm	317 mm	57 mm	1 piece
037.30.901W	037.30.901B	1000 ml	250 mm	390 mm	72 mm	1 piece



Due to their flat bottom construction these scoops can stand horizontal on a flat surface and can also be used as a weighing pan.



Same size scoops are easily stackable for reducing storage space. Different color options offer easy visual sorting.



With the help of precision formed sharp edge they offer best performance while picking up samples even from wet surfaces.

SCOOPS - "polystyrene" - "self standing" - "with & without lid"



► Manufactured from high quality polystyrene which resists to most acids, bases and many commonly used solvents. Guarantees temperature resistance between -10°C to +70°C.

► Perfect shape and size enable efficient sampling of various powder, granulate and paste form samples.

► 6 volume sizes from 25 ml to 500 ml offer an wide sampling option from smallest to largest sample volume.

► Due to their flat bottom and slightly inclined handle construction these scoops stand horizontal on the flat surfaces and can also be used as weighing pans.

► Easy to grip and long handle increases the distance between the hand and the sample to reduce cross contamination risks and also offers comfortable use.

► Approximate volume values are printed on the handles.

► **Alternative 2 scoops:** ► **Non-sterile scoops**
► **Gamma sterile scoops**

► Sterile scoops are manufactured at aseptically sterile production halls and then send to gamma sterilisation. Such informations as lot number, production and expiry dates etc are indicated on the packing.

► Sterile scoops are manufactured as single use. They eliminate the cost of separate sterile bags or containers in sample collection process.

► Sterile scoops are featured with a press-on, transparent lid which enables easy identification of sample and protects the samples from dust, moisture and other environmental effects.

► The transparent lid should be closed immediately after the sampling procedure to secure a sterile and contamination-free sample. Lid is featured with a frosted write on area.

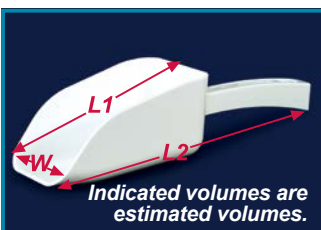

non-sterile white scoops	non-sterile blue scoops	gamma sterile white scoops with lid	volume	L1	L2	W	pack quantity
037.35.025W	037.35.025B	037.36.025W	25 ml	57 mm	137 mm	30 mm	1 piece
037.35.050W	037.35.050B	037.36.050W	50 ml	68 mm	158 mm	33 mm	1 piece
037.35.100W	037.35.100B	037.36.100W	100 ml	96 mm	200 mm	38 mm	1 piece
037.35.150W	037.35.150B	037.36.150W	150 ml	107 mm	215 mm	41 mm	1 piece
037.35.250W	037.35.250B	037.36.250W	250 ml	127 mm	243 mm	50 mm	1 piece
037.35.500W	037.35.500B	037.36.500W	500 ml	162 mm	292 mm	65 mm	1 piece



Precision formed sharp edge offers best performance while picking up samples even from wet surfaces.



Flat bottom and slightly inclined handle construction offer horizontal stand on the flat surfaces.



Easy to use: Detach the lid → Take the sample → Press-on the lid



Sterile scoops are featured with a press-on, transparent lid.

Non-sterile scoops are supplied without the lid.

lab consumables & labware



SCOOPS - "stainless steel"

- Manufactured from high quality, AISI 304 stainless steel.
- Suitable for spooning medium and large size products. Featured with a round formed spoon at one end and a steel handle at the other end.
- Robust and seamless construction guarantees long life cycle. Smooth polished surfaces provide easy cleaning.

catalogue number	scoop (∅) W	scoop L1	handle L2	pack quantity
037.08.050	50 mm	96 mm	92 mm	1 piece
037.08.075	75 mm	145 mm	100 mm	1 piece
037.08.100	100 mm	203 mm	102 mm	1 piece
037.08.120	120 mm	230 mm	105 mm	1 piece

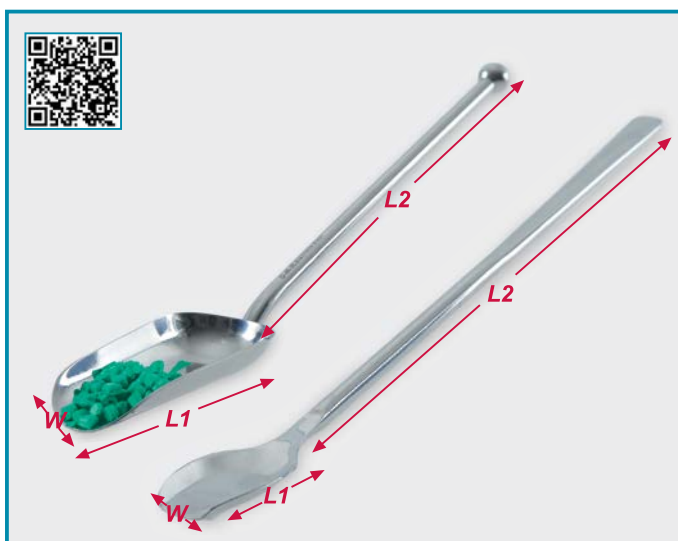

SCOOP & SPOON - "stainless steel"

- Manufactured from high quality, chemical and corrosion resistant AISI 304 grade stainless steel.
- Suitable for spooning small to medium size products. Featured with a round formed spoon at one end and a handle at the other end.
- Robust and seamless construction guarantees long life cycle.
- Smooth polished surfaces provide fast and easy cleaning.

scoop cat. no.	scoop (∅) W	scoop L1	handle L2	pack quantity
047.18.002	21 mm	63 mm	140 mm	1 piece

spoon cat. no.	scoop (∅) W	scoop L1	handle L2	pack quantity
047.18.001	11 mm	30 mm	160 mm	1 piece



SPOONS - "polystyrene" - "sterile"

- Manufactured from high quality polystyrene as single use.
- Resists to most acids, bases and many commonly used solvents. Guarantees temperature resistance between -10°C to +70°C.
- Sterile spoons are "DNase, RNase and pyrogen-free" since sterilised by gamma irradiation after production step. Individually single packed with lot number, production date and expiry date printed on the package.
- Approximate volume values are printed on the handles.
- Perfect shape and size enable efficient sampling of various powder, granulate and paste form samples.
- Easy to grip and long handle increases the distance between the hand and the sample to reduce cross contamination risks.

catalogue number	spoon volume	scoop (∅) W	spoon L1	handle L2	pack quantity
037.36.002	2,5 ml	22 mm	36 mm	54 mm	1 piece
037.36.010	10 ml	31 mm	56 mm	110 mm	1 piece

SPATULAS - "polypropylene" - "macro spoon"

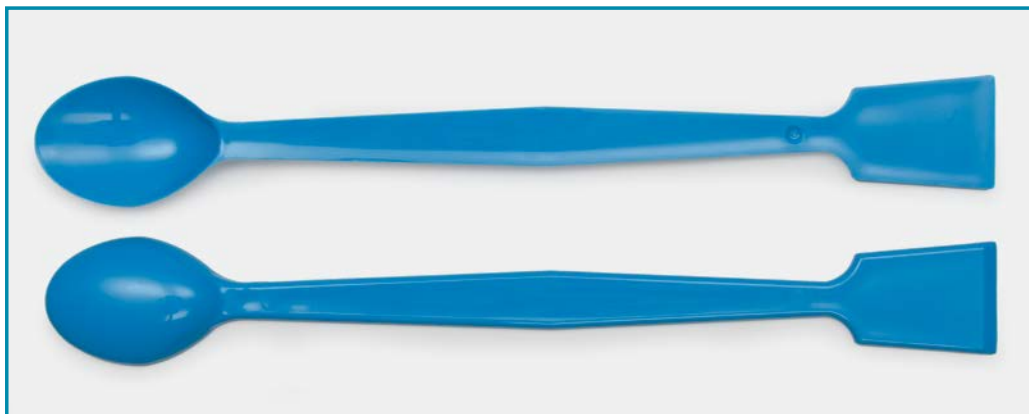

Flexible body form offers best sampling and collection options even for wet pastes.

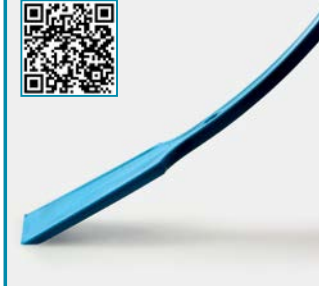

- Manufactured from high quality flexible polypropylene.
- Most commonly used spatula. Featured with a macro spoon form for small, medium and large size particles at one end and a straight/flat spatula form at the other end.
- Robust and seamless construction guarantees long life cycle. Smooth polished surfaces provide fast and easy cleaning.
- Also offers practical solutions for mixing and stirring solutions manually by hand.
- Flat end has 35 degree sharp edges for easy removal of the residues on flat surfaces.

- Flexible body form offers best sampling and collecting.

➤ Alternative 2 spatulas: ➤ Non-sterile spatulas ➤ Gamma sterile spatulas

- Gamma sterilised sterile spatulas carry such informations as lot number, production and expiry dates etc on the packing.

total length	non-sterile spatulas	gamma sterile spatulas	pack quantity
150 mm	047.32.150	047.33.150	1 piece
180 mm	047.32.180	047.33.180	1 piece
210 mm	047.32.210	047.33.210	1 piece



Featured with a macro spoon form for small, medium and large size particles

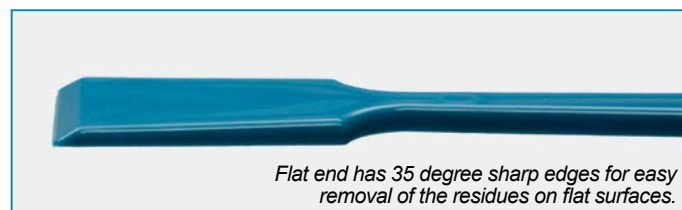

Flat end has 35 degree sharp edges for easy removal of the residues on flat surfaces.

SPATULAS - "sterile" - "with lid" - "polystyrene"

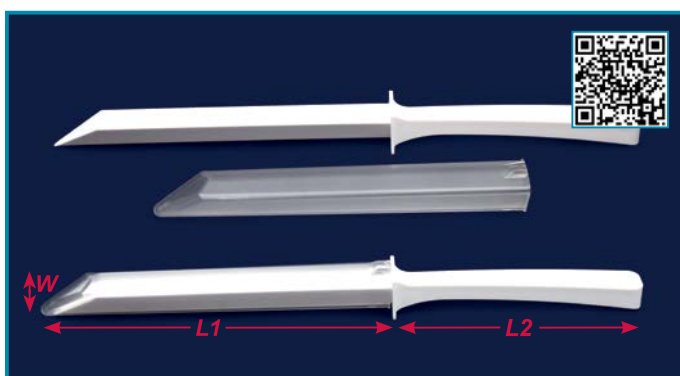

Sharp blade penetrates directly into paper or plastic bags for optimum and quick sampling process.

Spatulas are featured with a lid high protects the samples from dust, moisture and other effects.

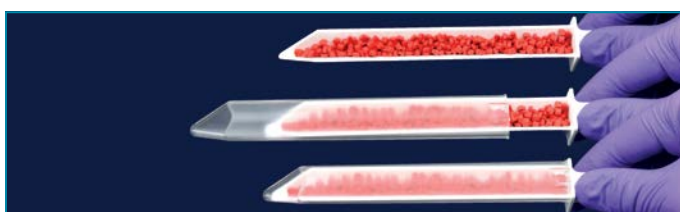

- Manufactured from high quality polystyrene which resists to most acids, bases and many commonly used solvents. Guarantees temperature resistance between -10°C to +70°C.

- Gamma sterile spatulas are manufactured as single use. They eliminate the cost of separate sterile bags or containers in sample collection.

- Perfect shape and size enable efficient sampling of various powder, granulate and paste form samples.

- Sharp blade penetrates directly into paper or plastic bags for optimum and quick sampling process.

- Easy to grip and long handle increases the distance between the hand and the sample to reduce cross contamination risks.

- Approximate volume values are printed on scoop handles.

- Sterile spatulas are featured with a transparent lid which protects the samples from dust, moisture and other effects.

- The transparent lid should be closed immediately after the sampling to secure a sterile and contamination-free sample.

- Lid is featured with a frosted write on area for practical use.

catalogue number	spatula (Ø) W	spatula L1	handle L2	pack quantity
037.36.001	13 mm	150 mm	110 mm	1 piece

lab consumables & labware



FORCEPS - "general use"

► Manufactured from AISI 304 grade stainless steel. Most commonly used forceps. Featured with a blunt point tip without jaw.

catalogue number	total length	pack quantity
048.01.105	105 mm	1 piece
048.01.115	115 mm	1 piece
048.01.130	130 mm	1 piece
048.01.145	145 mm	1 piece
048.01.160	160 mm	1 piece
048.01.200	200 mm	1 piece
048.01.250	250 mm	1 piece
048.01.300	300 mm	1 piece

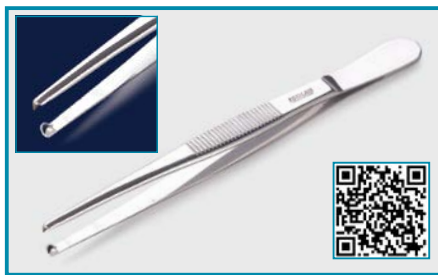

FORCEPS - "with tooth"

► Manufactured from AISI 304 grade stainless steel. Featured with a blunt point tip with a 1:2 array jaws for much effective and forced grasping.

catalogue number	total length	pack quantity
048.02.115	115 mm	1 piece
048.02.130	130 mm	1 piece
048.02.145	145 mm	1 piece
048.02.160	160 mm	1 piece



FORCEPS - "non-sterile"

► Manufactured from high quality, chemical and corrosion resistant ABS. Fine sharp tips and straight body form offer multiple advantages.



catalogue number	total length	pack quantity
048.10.110	110 mm	10 pieces



FORCEPS - "general use" - "sterile"

► Manufactured under germ-free gamma sterile conditions with extreme sterility control from ABS. Certified as "DNase, RNase and pyrogen-free since sterilised by gamma irradiation after production step.

► Individually single packed with lot number, production date and expiry date printed on the package.

catalogue number	total length	pack quantity
048.11.110	110 mm	1 piece



FORCEPS - "dissecting use"

► Manufactured from AISI 304 grade stainless steel. Most commonly used forceps for dissecting.

► Featured either with an straight fine sharp point tip or with curved inclined fine sharp point tip.

forceps with straight tip	forceps with curved tip	total length	pack quantity
048.07.105	048.08.105	105 mm	1 piece
048.07.115	048.08.115	115 mm	1 piece
048.07.130	048.08.130	130 mm	1 piece
048.07.150		150 mm	1 piece
048.07.160		160 mm	1 piece
048.07.200		200 mm	1 piece



FORCEPS - "for cover glasses"

► Manufactured from AISI 304 grade stainless steel. Most commonly used forceps for handling cover glasses.

► Featured either with a flat inclined tip or with a flat straight tip.

forceps with inclined tip	forceps with straight tip	total length	pack quantity
048.03.001	048.03.002	105 mm	1 piece



SCISSORS - "general use" - "sharp tip" & "blunt tip" & "blunt/sharp tip"

➤ Manufactured from AISI 304 grade stainless steel with straight form. Most commonly used scissors.

➤ Robust and seamless construction guarantees long life cycle.

total length	scissors sharp tip	scissors blunt tip	scissors blunt / sharp tip	pack quantity
130 mm	048.22.130	048.23.130	048.24.130	1 piece
160 mm	048.22.160	048.23.160	048.24.160	1 piece



SCISSORS - "dissecting use"

➤ Manufactured from AISI 304 grade stainless steel. Most commonly used scissors for dissecting.

➤ Featured either with a straight and fine sharp point tip or curved and fine sharp point tip.

scissor straight tip	scissor curved tip	total length	pack quantity
048.25.130	048.26.130	130 mm	1 piece



SCISSORS - "general use"

➤ Scissor part manufactured from high quality steel. Commonly used scissors for general applications. Featured with a straight and fine sharp point tips.

catalogue number	total length	pack quantity
048.30.130	130 mm	1 piece
048.30.160	160 mm	1 piece
048.30.200	200 mm	1 piece



SCISSORS - "heavy duty"

➤ Scissor part manufactured from high quality steel. Most commonly used scissor for cutting all materials even thin layer of metal sheets.

➤ Spring supported ergonomic plastic handle with safety lock offers easy, fast and safe use.

catalogue number	total length	pack quantity
048.31.001	185 mm	1 piece



CUTTERS

➤ Can be used as a cutter, as a safety knife suitable for detailed precise cutting. Both models are featured with both a break-off device.

➤ Large cutter is also featured with an auto-lock knob as additional safety.

➤ Light weight and ergonomic handle offers excellent grip option.

catalogue number	blade length	blade width	pack quantity
048.06.001	80 mm	9 mm	1 piece
048.06.002	100 mm	18 mm	1 piece

lab consumables & labware

SCALPEL - "with safety cover"

- Single packed sterile scalpel featured with highest grade stainless steel cutting blade.
- Handle is manufactured from polypropylene with a soft grip option.
- The safety cover closes the blade part securely and prevents the unexpected cut risks.

catalogue number	total length	blade length	pack quantity
048.50.003	140 mm	40 mm	1 piece

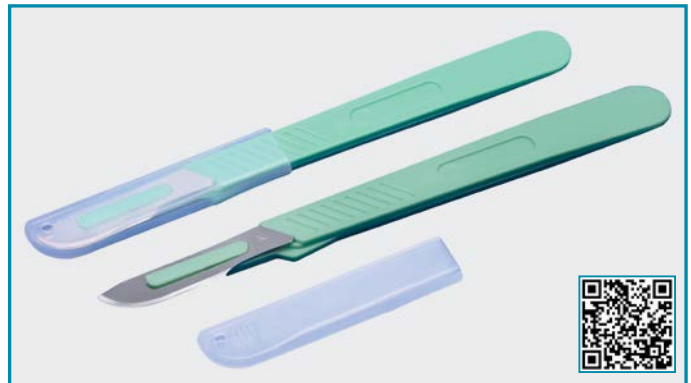

SCALPEL HANDLES

- Manufactured from stainless steel with approximate length of 130 mm.
- Handle no: 1 carries blades size from 10 to 18. Handle no: 2 carries blade size from 18 to 24.
- Grids at the front part guarantees perfect control during usage.

catalogue number	handle no	total length	pack quantity
048.50.001	1	130 mm	1 piece
048.50.002	2	130 mm	1 piece



SCALPEL BLADE - "no:10"

- Manufactured from carbon steel and sterilised with gamma radiation.
- Suitable to be used with scalpel handle no: 1.

catalogue number	for handle	blade length	pack quantity
048.51.010	no:1	25 mm	100 pieces



SCALPEL BLADE - "no:11"

- Manufactured from carbon steel and sterilised with gamma radiation.
- Suitable to be used with scalpel handle no: 1.

catalogue number	for handle	blade length	pack quantity
048.51.011	no:1	20 mm	100 pieces

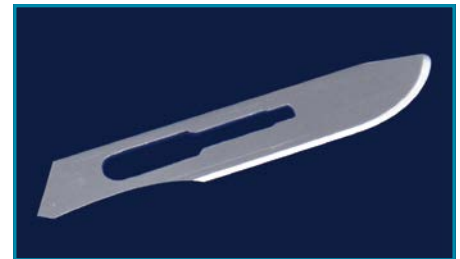

SCALPEL BLADE - "no:21"

- Manufactured from carbon steel and sterilised with gamma radiation.
- Suitable to be used with scalpel handle no: 2.

catalogue number	for handle	blade length	pack quantity
048.51.021	no:2	35 mm	100 pieces



DISSECTING NEEDLES

- Needle parts are manufactured from stainless steel with sharp ends.
- Supplied as a set consisting of 3 needles:

- dissecting needle, **straight**
- dissecting needle, **bent**
- dissecting needle, **lanceolated**

catalogue number	pack quantity
052.30.001	1 set



BUNSEN BURNER "standard type"

- Most common used Bunsen burner with flame adjustment.
- Can be used with all gases such as neutral gas, butane gas and coal gas.
- Offers practical control of flame from very slow heating to rapid boiling with an adjustable air and gas regulation ring.
- Precise flame adjustment is guaranteed by a screw driven gas control knob.

catalogue number	pack quantity
050.01.001	1 piece



BUNSEN BURNER "advanced type"

- Preferably used if higher heating capacity is required.
- Can be used with all gases such as neutral gas, butane gas and coal gas.
- Offers practical control of flame from very slow heating to rapid boiling with an adjustable air and gas regulation ring.
- Precise flame adjustment is guaranteed by a screw driven gas control knob.

catalogue number	pack quantity
050.01.002	1 piece



BUNSEN BURNER "meker type"

- For very high heating heating up to 1700°C is required.
- Can be used with all gases such as neutral gas, butane gas and coal gas.
- Offers practical control of flame from very slow heating to rapid boiling with an adjustable air and gas regulation ring.
- Precise flame adjustment is guaranteed by a screw driven gas control knob.

catalogue number	pack quantity
050.01.003	1 piece



BUNSEN BURNER STABILIZER

- There is always a tilt over risk for Bunsen burners.
- Bunsen burner stabilizer provides a very stable and robust additional base and holds the attached Bunsen burner firmly avoiding above mentioned risk.
- The nest perfectly fits to the bases of Bunsen burners with catalogue no: 050.01.002 and 050.01.003.
- First insert the Bunsen burner into the stabilizer nest. Then stabilize the Bunsen burner by fixing the provided screw tightly.

catalogue number	pack quantity
050.09.001	1 piece



CAMP BURNER

- Can be used where connection to a gas pipe line is not existing. Supplied without gas cartridge.

catalogue number	pack quantity
050.01.004	1 piece



BLOW LAMP "cartridge type"

- Multi purpose blow lamp can be used where connection to a gas pipe line is not existing.
- Precise flame adjustment by a screw driven gas control knob.
- Supplied without gas cartridge. Kindly order gas cartridge separately.

blow lamp	spare gas cartridge	pack quantity
050.02.001	050.03.001	1 piece



HOSES - "for Bunsen burners"

- Manufactured from extra thick walled rubber. Specially designed to be used with Bunsen burners. Reinforced ends fits perfect to the Bunsen burner at one side and the gas tap at the other side assuring gas leakage free connection.

catalogue number	pack quantity
050.08.075	1 piece
050.08.100	1 piece



DESICCATORS "glass" - "non-vacuum"

- Manufactured thick, robust and heat resistant, durable borosilicate glass without vacuum stopcock.
- Excellent smooth grinded body and lid flanges guarantee airtight closure. Supplied with a porcelain perforated desiccator plate.

catalogue number	desiccator diameter	pack quantity
039.01.200	200 mm	1 piece
039.01.250	250 mm	1 piece
039.01.300	300 mm	1 piece

spare lid for non-vacuum desc.	lid diameter	pack quantity
039.06.200	200 mm	1 piece
039.06.250	250 mm	1 piece
039.06.300	300 mm	1 piece



DESICCATORS "glass" - "vacuum"

- Manufactured from borosilicate glass. Featured with a 2-way high vacuum stopcock enabling consistent and uniform vacuum draw and release.
- Excellent smooth grinded body and lid flanges guarantee airtight closure. Supplied with a porcelain perforated desiccator plate.

catalogue number	desiccator diameter	pack quantity
039.02.200	200 mm	1 piece
039.02.250	250 mm	1 piece
039.02.300	300 mm	1 piece

spare lid for vacuum desc.	lid diameter	pack quantity
039.07.200	200 mm	1 piece
039.07.250	250 mm	1 piece
039.07.300	300 mm	1 piece



DESICCATORS "P.P & P.C" - "vacuum"

- Manufactured P.P base with transparent P.C cover. Featured with a 3-way high vacuum stopcock enabling consistent and uniform vacuum draw and release.
- Silicone gasket between body and the lid ensures airtight closure. Supplied with a polypropylene perforated desiccator plate.

catalogue number	desiccator diameter	pack quantity
039.12.200	200 mm	1 piece
039.12.250	250 mm	1 piece
039.12.300	300 mm	1 piece

spare porcelain desiccator plates	lid diameter	pack quantity
039.05.200	190 mm	1 piece
039.05.250	235 mm	1 piece
039.05.300	300 mm	1 piece

SILICA - GEL DESICCANT BEADS

- Silica-Gel beads are moisture absorbing self - indicating drying agents.
- Perfect substitute of classical desiccator moisture absorbents.
- Beads has a grain size variable from 1 to 3 mm. They are free from any heavy and environmentally compatible.
- Original orange color gradually turns to white as the gel absorbs moisture.
- Color change offers monitoring of the saturation level.
- Silica-Gel beads can be regenerated when heated at a temperature of maximum 120°C.
- The color turns back to original orange color.
- Packed as 1 kg in a sealed P.P bottle in order to prevent preabsorption of moisture.

catalogue number	packing specification
039.16.001	1 kg in P.P bottle





MORTARS - "agate"

- Manufactured from high quality, natural agate stone with standard depth.
- Supplied with a pestle with relevant size to agate mortar.

catalogue number	volume	ext. dia	height	pack quantity
038.07.050	9 ml	50 mm	25 mm	1 piece
038.07.075	22 ml	75 mm	30 mm	1 piece
038.07.100	50 ml	100 mm	40 mm	1 piece
038.07.125	120 ml	125 mm	45 mm	1 piece
038.07.150	270 ml	150 mm	55 mm	1 piece

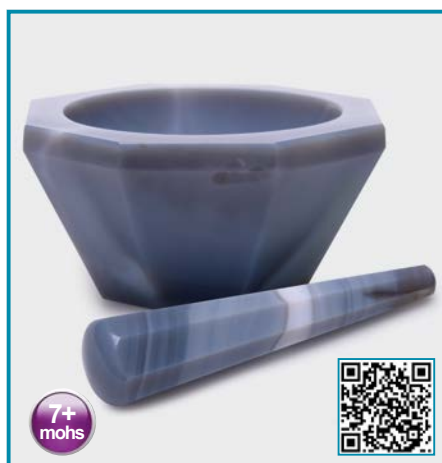

MORTARS - "deep form"

- Manufactured from high quality, natural agate stone with extra depth compared to standard deep mortars.
- Supplied with a pestle with relevant size to agate mortar.

catalogue number	volume	ext. dia	height	pack quantity
038.09.060	25 ml	60 mm	35 mm	1 piece
038.09.070	35 ml	70 mm	40 mm	1 piece
038.09.080	60 ml	80 mm	45 mm	1 piece
038.09.100	100 ml	100 mm	55 mm	1 piece
038.09.120	165 ml	120 mm	60 mm	1 piece



MORTARS - "black agate"

- Manufactured from high quality, natural black agate stone with standard depth.
- Supplied with a pestle with relevant size to agate mortar.

catalogue number	volume	ext. dia	height	pack quantity
038.18.065	25 ml	65 mm	30 mm	1 piece
038.18.085	70 ml	85 mm	35 mm	1 piece
038.18.110	140 ml	115 mm	45 mm	1 piece
038.18.125	210 ml	125 mm	50 mm	1 piece
038.18.150	350 ml	150 mm	55 mm	1 piece



MORTARS - "alsint"

- Manufactured from extremely chemical resistant pure 99,7 % aluminium oxide (alsint).
- Recommended for use absolute contamination free crushing.
- Supplied with a pestle with relevant size to alsint mortar.

catalogue number	volume	ext. dia	height	pack quantity
038.08.050	7 ml	50 mm	26 mm	1 piece
038.08.075	30 ml	75 mm	40 mm	1 piece
038.08.100	80 ml	100 mm	48 mm	1 piece
038.08.125	120 ml	125 mm	70 mm	1 piece
038.08.150	150 ml	150 mm	75 mm	1 piece



MORTARS - "porcelain"

- Manufactured from high quality, glazed porcelain according to DIN 12906 standard.
- Grinding chamber made from unglazed porcelain provides perfect hold of the samples during crushing without splattering.
- **Supplied without pestle. Please select the appropriate pestle.**

catalogue number	volume	ext. dia	height	pack quantity
038.02.065	70 ml	80 mm	40 mm	1 piece
038.02.090	170 ml	105 mm	55 mm	1 piece
038.02.130	400 ml	150 mm	70 mm	1 piece
038.02.150	700 ml	175 mm	70 mm	1 piece
038.02.180	1000 ml	207 mm	80 mm	1 piece



PESTLES - "porcelain"

- Manufactured from high quality, glazed porcelain according to DIN 12906 standard.
- Grinding head made from unglazed porcelain for crushing without splattering.

catalogue number	head diameter	total length	pack quantity
038.03.115	24 mm	115 mm	1 piece
038.03.135	30 mm	135 mm	1 piece
038.03.150	36 mm	150 mm	1 piece
038.03.175	42 mm	175 mm	1 piece
038.03.210	55 mm	210 mm	1 piece



EVAPORATING DISHES "porcelain" - "flat base"

➤ Manufactured from high quality, glazed porcelain according to DIN 12903 standard.

catalogue number	volume	ext. dia	height	pack quantity
038.11.060	20 ml	63 mm	13 mm	6 pieces
038.11.080	40 ml	80 mm	20 mm	6 pieces
038.11.100	80 ml	110 mm	25 mm	6 pieces
038.11.125	270 ml	125 mm	27 mm	6 pieces
038.11.160	450 ml	160 mm	35 mm	6 pieces

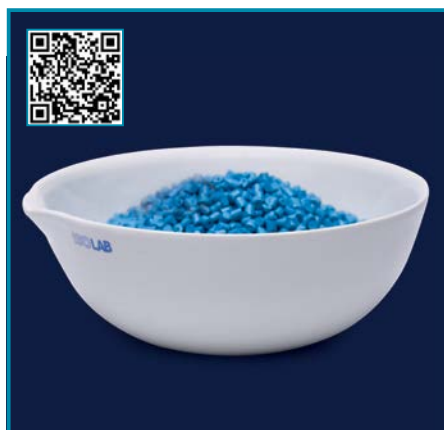

EVAPORATING DISHES "porcelain" - "round base"

➤ Manufactured from high quality, glazed porcelain according to DIN 12903 standard.

catalogue number	volume	ext. dia	height	pack quantity
038.12.060	40 ml	60 mm	25 mm	6 pieces
038.12.080	75 ml	80 mm	30 mm	6 pieces
038.12.100	180 ml	100 mm	45 mm	6 pieces
038.12.125	310 ml	125 mm	48 mm	6 pieces
038.12.160	640 ml	160 mm	58 mm	6 pieces



CRYSTALLIZATION DISHES "glass" - "flat base"

➤ Manufactured from heat resistant, durable borosilicate glass according to DIN 12338.

catalogue number	volume	ext. dia	height	pack quantity
049.05.060	85 ml	60 mm	35 mm	1 piece
049.05.100	110 ml	70 mm	40 mm	1 piece
049.05.150	160 ml	80 mm	45 mm	1 piece
049.05.300	280 ml	95 mm	55 mm	1 piece
049.05.900	860 ml	140 mm	75 mm	1 piece



EVAPORATING DISHES "st. steel" - "round base"

➤ Manufactured from high quality, chemical and corrosion resistant AISI 304 grade stainless steel.

catalogue number	volume	ext. dia	height	pack quantity
038.14.060	50 ml	60 mm	30 mm	1 piece
038.14.080	125 ml	80 mm	40 mm	1 piece
038.14.100	250 ml	100 mm	55 mm	1 piece



CRYSTALLIZATION DISHES "st. steel" - "flat base"

➤ Manufactured from high quality, chemical and corrosion resistant AISI 304 grade stainless steel.

catalogue number	volume	ext. dia	height	pack quantity
049.08.070	100 ml	70 mm	35 mm	1 piece
049.08.085	150 ml	85 mm	45 mm	1 piece
049.08.110	400 ml	110 mm	55 mm	1 piece



CRUCIBLES "st. steel" - "medium form"

➤ Manufactured from high quality, chemical and corrosion resistant AISI 304 grade stainless steel.

catalogue number	external diameter	height	pack quantity
038.13.S35	44 mm	35 mm	1 piece
038.13.S45	51 mm	45 mm	1 piece
038.13.S50	63 mm	50 mm	1 piece



COMBUSTION BOATS - "porcelain"

➤ Manufactured from high quality, glazed porcelain.

➤ In order to prevent breakage controlled cooling and preventing use with direct flame is recommended.

catalogue number	dimensions	height	pack quantity
038.17.001	88 x 12 mm	10 mm	10 pieces



CRUCIBLES - "porcelain"

► Manufactured from high quality, glazed porcelain according to DIN 12904 standard.

► In order to prevent breakage controlled cooling and preventing use with direct flame is recommended.

► Supplied without lid. Please select the appropriate size from lid options.



catalogue number	external diameter	height	pack quantity
038.14.L30	30 mm	18 mm	6 pieces
038.14.L35	35 mm	23 mm	6 pieces
038.14.L40	40 mm	25 mm	6 pieces
038.14.L45	45 mm	29 mm	6 pieces
038.14.L50	50 mm	32 mm	6 pieces
038.14.L60	60 mm	38 mm	6 pieces
038.14.L70	70 mm	48 mm	6 pieces

catalogue number	external diameter	height	pack quantity
038.14.M35	35 mm	28 mm	6 pieces
038.14.M40	40 mm	32 mm	6 pieces
038.14.M45	45 mm	36 mm	6 pieces
038.14.M50	50 mm	40 mm	6 pieces
038.14.M60	60 mm	50 mm	6 pieces
038.14.M70	70 mm	60 mm	6 pieces
038.14.M82	82 mm	65 mm	6 pieces

catalogue number	external diameter	height	pack quantity
038.14.H30	30 mm	38 mm	6 pieces
038.14.H35	35 mm	44 mm	6 pieces
038.14.H40	40 mm	49 mm	6 pieces
038.14.H46	46 mm	58 mm	6 pieces
038.14.H51	51 mm	65 mm	6 pieces
038.14.H60	60 mm	79 mm	6 pieces

CRUCIBLE LIDS

► Manufactured from high quality, glazed porcelain according to DIN 12904 standard.



catalogue number	external diameter	pack quantity
038.19.035	35 mm	6 pieces
038.19.043	43 mm	6 pieces
038.19.046	46 mm	6 pieces
038.19.052	52 mm	6 pieces
038.19.060	60 mm	6 pieces
038.19.068	68 mm	6 pieces

INCINERATING DISHES
"porcelain" - "cylindrical"

► Manufactured from high quality, glazed porcelain.

catalogue number	internal diameter	height	pack quantity
038.21.040	40 mm	21 mm	1 piece
038.21.050	50 mm	25 mm	1 piece
038.21.060	60 mm	31 mm	1 piece

INCINERATING DISHES
"porcelain" - "rectangular"

► Manufactured from high quality, glazed porcelain.

catalogue number	dimensions	height	pack quantity
038.20.025	50 x 25 mm	10 mm	1 piece
038.20.046	70 x 46 mm	13 mm	1 piece
038.20.055	100 x 55 mm	16 mm	1 piece

CRUCIBLES
"alsint" - "wide & tall form"

► Manufactured from extremely chemical resistant pure 99,7 % aluminium oxide (alsint) resistant to 1700°C.

► In order to prevent breakage controlled cooling and preventing use with direct flame is recommended.

catalogue number	external diameter	height	pack quantity
038.13.A30	30 mm	24 mm	1 piece
038.13.A41	41 mm	37 mm	1 piece
038.13.A48	48 mm	41 mm	1 piece
038.13.A54	54 mm	50 mm	1 piece
038.13.A60	60 mm	50 mm	1 piece
038.13.A66	66 mm	56 mm	1 piece



TUBINGS - "rubber" "standard type"

- Manufactured from natural rubber with standard thickness of durometer 45 A.
- Guarantees excellent chemical and temperature resistance between -25°C to +70°C.

catalogue number	int. / ext. diameter	wall thickness	pack quantity
052.10.001	5/8 mm	1,5 mm	1 meter
052.10.002	5/9 mm	2,0 mm	1 meter
052.10.003	6/9 mm	1,5 mm	1 meter
052.10.004	6/10 mm	2,0 mm	1 meter
052.10.005	7/11 mm	2,0 mm	1 meter
052.10.006	8/12 mm	2,0 mm	1 meter
052.10.007	10/14 mm	2,0 mm	1 meter
052.10.008	12/16 mm	2,0 mm	1 meter



TUBINGS - "rubber" "vacuum type"

- Manufactured from natural rubber with thickness required by vacuum applications with durometer 45 A.
- Guarantees excellent chemical and temperature resistance between -25°C to +70°C.

catalogue number	int. / ext. diameter	wall thickness	pack quantity
052.11.001	6/16 mm	5,0 mm	1 meter
052.11.002	7/17 mm	5,0 mm	1 meter
052.11.003	8/18 mm	5,0 mm	1 meter
052.11.004	10/20 mm	5,0 mm	1 meter



TUBINGS - "silicone" "standard type"

- Manufactured from natural silicone with standard thickness of durometer 45 A.
- Guarantees excellent chemical and temperature resistance between -60°C to +170°C.

catalogue number	int. / ext. diameter	wall thickness	pack quantity
052.12.001	3/6 mm	1,5 mm	1 meter
052.12.002	4/7 mm	1,5 mm	1 meter
052.12.003	5/8 mm	1,5 mm	1 meter
052.12.004	6/10 mm	2,0 mm	1 meter
052.12.005	7/11 mm	2,0 mm	1 meter
052.12.006	8/12 mm	2,0 mm	1 meter
052.12.007	9/13 mm	2,0 mm	1 meter
052.12.008	10/14 mm	2,0 mm	1 meter



TUBINGS - "PTFE" - standard type"

- Manufactured from chemically inert PTFE with excellent mechanical strength.
- Guarantees excellent chemical and temperature resistance between -200°C to +280°C.

catalogue number	int. / ext. diameter	wall thickness	pack quantity
052.13.001	0,5/1 mm	0,25 mm	1 meter
052.13.002	1/1,5 mm	0,25 mm	1 meter
052.13.003	1/2 mm	0,50 mm	1 meter
052.13.004	1,5/3,5 mm	1,00 mm	1 meter
052.13.005	2/4 mm	1,00 mm	1 meter
052.13.006	3/5 mm	1,00 mm	1 meter
052.13.007	4/6 mm	1,00 mm	1 meter
052.13.008	6/8 mm	1,00 mm	1 meter
052.13.009	8/10 mm	1,00 mm	1 meter



SCISSORS - "for hose cutting"

- Offers a clean and sharp cut of all kinds of hoses with external diameter range 6 mm to 25 mm.
- The cutter blade is manufactured from stainless steel with two ends. If one cutting end gets blunt, the other side can be used.

catalogue number	pack quantity
052.08.002	1 piece



Offers a clean and sharp cut of all kinds of hoses with external diameter range 6 mm to 25 mm.



TUBING CLAMPS - "click-lock"

- Manufactured with a stainless steel clamp and HIPS pressure plate for reliable and precise flow control.
- Can be used wherever the flow rates at tubings with liquids and gases need to be regulated or stopped.
- The micro screw system enables a fine and stepless adjusted flow control.
- The clamp can be opened and closed at any position without tiresome screwing.
- The unique construction enables easy mount of the clamp even when the tubing is already connected to a system.
- Adjustable pressure plate compress the tubing over a wide area against the stainless hook in order to prevent damages.

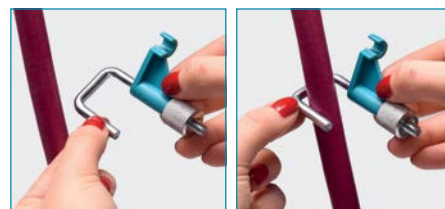

Open the clamp screws

Attach the clamp easily

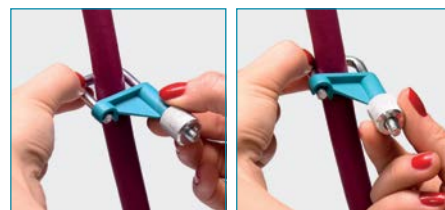

"Click" the clamp

Regulate the flow

max. hose diameter	blue clamps catalogue no	red clamps catalogue no	orange clamps catalogue no	pack quantity
up to 10 mm	052.15.010B	052.15.010R	052.15.010O	1 piece
up to 15 mm	052.15.015B	052.15.015R	052.15.015O	1 piece
up to 20 mm	052.15.020B	052.15.020R	052.15.020O	1 piece



TUBING CLAMPS - "hoffman"

- Manufactured from chrome plated steel for reliable and precise flow control of liquids and gases.
- Can be used wherever the flow rates at tubings with liquids and gases need to be regulated or stopped.
- The swing-open hinged bottom bar enables a fine and stepless adjusted flow control. Variably adjustable up to the total closure of the tubing.
- The unique construction enables easy mount of the clamp even when the tubing is already connected to a system.

catalogue number	for hose	pack quantity
052.17.012	12 mm	1 piece
052.17.020	20 mm	1 piece
052.17.030	30 mm	1 piece



TUBING CLAMPS - "worm drive"

- Ideal clamps for safe fastening and securing tubings on pipe systems or to stopcocks.
- Manufactured from chrome steel according to DIN 3017 standard.

catalogue number	for hose Ø (mm)	pack quantity
052.16.012	8-12	1 piece
052.16.016	10-16	1 piece
052.16.020	12-20	1 piece
052.16.025	16-25	1 piece

TUBE CONNECTORS - "L" - "Y" - "T" - "X"

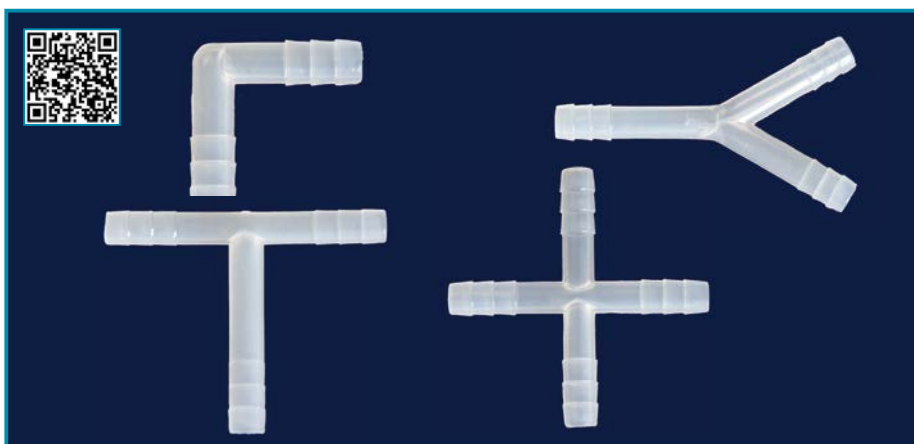

- Manufactured from clear polypropylene for safe connection of tubings with exactly same inner diameter.
- 4 available models provide excellent, leak-proof and multi-functional connection.

ID hose diameters	"L" model catalogue no	"Y" model catalogue no	"T" model catalogue no	"X" model catalogue no	pack quantity
6 mm	052.22.006	052.23.006	052.24.006	052.25.006	1 piece
8 mm	052.22.008	052.23.008	052.24.008	052.25.008	1 piece
10 mm	052.22.010	052.23.010	052.24.010	052.25.010	1 piece



STOPPERS
"rubber"

➤ Manufactured from additive free, best quality natural rubber according to DIN 12871 standard with durometer 40 A.

➤ Guarantees excellent chemical and temperature resistance between -25°C to +70°C.



STOPPERS
"silicone"

➤ Manufactured from chemically inert, autoclavable, best quality natural silicone according to DIN 12871 standard with durometer 50 A.

➤ Guarantees excellent chemical and temperature resistance between -60°C to +170°C.



STOPPERS
"cork"

➤ Manufactured from non-porous, additive free, best quality natural cork according to DIN 12871 standard dimensions.

➤ Offers multi advantages with their light weight yet robust construction. Can be easily drilled.



STOPPERS -
"turn - over flange"

➤ Manufactured from chemically inert, autoclavable, best quality natural silicone.

➤ Guarantees excellent chemical and temperature resistance between -60°C to +170°C.

➤ They provide perfect tight sealing even with poorly finished rims preventing accidental openings.

➤ Offers optional sealing both from inside or outside of the tube wall.

➤ For sampling the upper septum can be easily punctured. Flexible body material reseals.

bottom Ø mm	top Ø mm	height mm	stoppers rubber	stoppers silicone	pack quantity	stoppers cork	pack quantity
3,5	6,5	15,0	051.20.001	051.22.001	10 pcs.	051.23.001	10 pcs.
5,0	9,0	20,0	051.20.002	051.22.002	10 pcs.	051.23.002	10 pcs.
8,0	12,0	20,0	051.20.003	051.22.003	10 pcs.	051.23.003	10 pcs.
10,5	14,5	20,0	051.20.004	051.22.004	10 pcs.	051.23.004	10 pcs.
12,5	16,5	20,0	051.20.005	051.22.005	10 pcs.	051.23.005	10 pcs.
14,0	18,0	20,0	051.20.006	051.22.006	10 pcs.	051.23.006	10 pcs.
17,0	22,0	25,0	051.20.007	051.22.007	10 pcs.	051.23.007	10 pcs.
18,0	24,0	30,0	051.20.008	051.22.008	10 pcs.	051.23.008	10 pcs.
21,0	27,0	30,0	051.20.009	051.22.009	10 pcs.	051.23.009	10 pcs.
23,0	29,0	30,0	051.20.010	051.22.010	10 pcs.	051.23.010	10 pcs.
26,0	32,0	30,0	051.20.011	051.22.011	10 pcs.	051.23.011	10 pcs.
29,0	35,0	30,0	051.20.012	051.22.012	10 pcs.	051.23.012	10 pcs.
31,0	38,0	35,0	051.20.013	051.22.013	10 pcs.	051.23.013	10 pcs.
36,0	44,0	40,0	051.20.014	051.22.014	10 pcs.	051.23.014	10 pcs.
41,0	49,0	40,0	051.20.015	051.22.015	6 pcs.	051.23.015	10 pcs.
47,0	55,0	40,0	051.20.016	051.22.016	6 pcs.	051.23.016	10 pcs.
50,5	59,5	45,0	051.20.017	051.22.017	6 pcs.	051.23.017	10 pcs.
56,0	65,0	45,0	051.20.018	051.22.018	6 pcs.	051.23.018	10 pcs.
60,0	70,0	50,0	051.20.019	051.22.019	6 pcs.	051.23.019	10 pcs.
64,5	75,5	55,0	051.20.020	051.22.020	3 pcs.	051.23.020	10 pcs.
71,0	83,0	60,0	051.20.021	051.22.021	3 pcs.	051.23.021	10 pcs.
79,0	92,0	65,0	051.20.022	051.22.022	3 pcs.	051.23.022	10 pcs.

how to select proper size stopper?

Attached table indicates technical dimensions of NS joints. Please examine the related NS size and select the right stopper from the catalogue list.

Please pay attention to select a larger stopper for perfect closure of the joint.

NS size	total height	diameter narrow end	diameter wide end
10/19	19,00 mm	8,02 mm	10,00 mm
12/21	21,00 mm	10,50 mm	12,50 mm
14/23	23,00 mm	12,17 mm	14,50 mm
19/26	26,00 mm	16,01 mm	18,80 mm
24/29	29,00 mm	20,95 mm	24,00 mm
29/32	32,00 mm	26,12 mm	29,20 mm
34/35	35,00 mm	30,77 mm	34,50 mm



catalogue number	effective diameter	pack quantity
051.26.001	7,1 mm	10 pieces
051.26.002	10,2 mm	10 pieces
051.26.003	12,7 mm	10 pieces
051.26.004	14,9 mm	10 pieces
051.26.005	15,9 mm	10 pieces
051.26.006	19,4 mm	10 pieces
051.26.007	23,7 mm	10 pieces
051.26.008	30,7 mm	10 pieces

STOPPERS - "hallow glass" - "hexagonal"

- Manufactured from borosilicate glass according to DIN 12252.
- Hexagonal flat head prevents the stopper from rolling on the bench and avoids the breakage risk.
- A pointed, round formed "drip-tip" stopper lower end guarantees return of the adhered liquid back to the flasks.

NS size	stoppers clear	pack quantity	stoppers amber	pack quantity
NS 10/19	051.03.001	10 pieces	051.04.001	1 piece
NS 12/21	051.03.002	10 pieces	051.04.002	1 piece
NS 14/23	051.03.003	10 pieces	051.04.003	1 piece
NS 19/26	051.03.004	10 pieces	051.04.004	1 piece
NS 24/29	051.03.005	10 pieces	051.04.005	1 piece
NS 29/32	051.03.006	10 pieces	051.04.006	1 piece
NS 34/35	051.03.007	10 pieces	051.04.007	1 piece



STOPPERS - "rubber" - "drilled"

- Manufactured from additive free, best quality natural rubber according to DIN 12871 standard with durometer 40 A.
- The drilled hole offers labour and time saving applications.

catalogue number	bottom Ø mm	top Ø mm	hole Ø mm	pack quantity
051.21.001	10,5	14,5	3,0	1 piece
051.21.002	12,5	16,5	3,0	1 piece
051.21.003	14,0	18,0	3,0	1 piece
051.21.004	17,0	22,0	4,0	1 piece
051.21.005	18,0	24,0	4,0	1 piece
051.21.006	21,0	27,0	5,0	1 piece
051.21.007	23,0	29,0	5,0	1 piece
051.21.008	26,0	32,0	6,0	1 piece
051.21.009	29,0	35,0	6,0	1 piece
051.21.010	31,0	38,0	7,0	1 piece

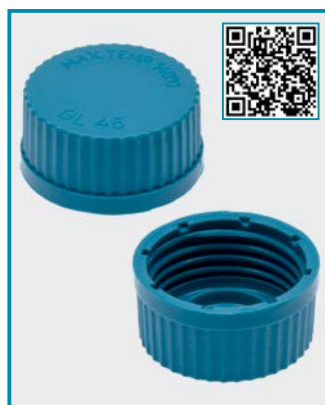

STOPPERS "polyethylene"

- Manufactured from polyethylene for perfect tight sealing for all NS joints.
- Hexagonal flat head prevents the stopper from rolling on the bench and avoids the breakage risk.
- The hallow form of the stopper head collects the adhered liquid and prevents the possible damage risk of the laboratory benches.

catalogue number	NS size	pack quantity
051.08.010	NS 10/19	10 pieces
051.08.012	NS 12/21	10 pieces
051.08.014	NS 14/23	10 pieces
051.08.019	NS 19/26	10 pieces
051.08.024	NS 24/29	10 pieces
051.08.029	NS 29/32	10 pieces



CAPS - "polypropylene"

- Manufactured from polypropylene for perfect and tight closure of GL 45 screw necked laboratory bottles.



- Large ridges on the cap outer surface guarantees for increased grip and fast closure.
- Color coded caps enable fast, easy and practical identification of bottle content.

catalogue number	color	pack quantity
051.09.45R	red	10 pieces
051.09.45Y	yellow	10 pieces
051.09.45B	blue	10 pieces
051.09.45G	green	10 pieces

STOPPERS - "flange" - "polyethylene"

- Manufactured from polyethylene for perfect tight sealing of specially test tubes. Grooved, conical body shape and large size flanges on the stopper perfectly touch to the walls of the tubes and offer the best leak-proof sealing.

catalogue number 13 mm	catalogue number 16 mm	color	pack quantity
051.10.001	051.11.001	clear	100 pieces
051.10.002	051.11.002	dark blue	100 pieces
051.10.003	051.11.003	yellow	100 pieces
051.10.004	051.11.004	red	100 pieces
051.10.005	051.11.005	green	100 pieces

lab consumables & labware

CLING FILM

- Manufactured from PVC based resin with extremely good stretching, and adhesion characteristics. Perfect tool for sealing and wrapping of various labware.
- Offers an easy use and easy for unravel application.
- Stretches and widens up 50% of original length. Clings around the labware and seals labware with leak-proof tightness.
- Waterproof. Chemically inert and resistant to most organic solvents and caustic agents.
- Remains flexible in moderate freezing temperatures. Can resist up to 75°C.



Offers extremely good stretching, and adhesion characteristics. Perfect tool for sealing and wrapping of various labware.

catalogue number	roll width	roll length	foil thickness	pack quantity
058.03.001	300 mm	90 m	0,011 mm	1 piece



SEALING FILM - "parafilm"

- Most common sealing film used in laboratories.
- Manufactured from polioefin and paraffin mixture.
- Guarantees excellent chemical to salt, inorganic and alkaline solutions up to 48 hours and offers temperature resistance between -45°C to +500°C.
- Stretches and widens up 200% of original length.
- Clings around flask necks circumference and seal irregular perimeters of flasks, erlenmeyers, bottles, beakers etc. with leak-proof tightness.
- Also prevents breakage risk of flask neck and spillage of flask contents in case of a tilt over.



Clings around flask neck circumference and seal irregular perimeters of flasks, erlenmeyers, bottles, beakers etc. with leak-proof tightness.

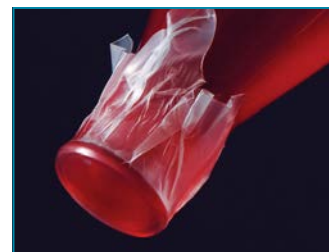

catalogue number	width	length	pack quantity	box quantity
058.01.001	50 mm	75 mt	1 piece	12 pieces
058.01.002	100 mm	38 mt	1 piece	12 pieces



PARAFILM DISPENSER

- Perfect tool for safe and easy cutting of 100 mm and 50 mm width parafilms.
- Keeps the remaining part unaffected from environmental conditions.
- Can cut one roll of 100 mm or simultaneously 2 rolls of 50 mm width parafilm.
- Manufactured from ABS and featured with a double action cutting blade that slides and cuts.
- The clear hinged lid enables visual control of the remaining parafilm roll.
- Unique design of the blade holder guarantees easy handling.
- The cutting blade can easily slide in both directions providing a clean and uninterrupted cut.
- The cutting blade is embedded in a holding block ensuring finger safety.

dispenser cat. number	dimensions	body color	pack quantity
058.02.001B	120 x 140 x 140 mm	blue	1 piece
058.02.001P	120 x 140 x 140 mm	purple	1 piece
058.02.001R	120 x 140 x 140 mm	ruby	1 piece



Push the cutting mechanism of the dispenser backwards.



Place the parafilm and move the mechanism back to original position.



Pull out the necessary length from dispenser for cutting.



Parafilm is cut with one movement of the blade from side to side.

SPARE CUTTING BLADE

- Unique design of the blade holder guarantees easy handling.
- The cutting blade is embedded in a holding block ensuring finger safety.
- It is recommended that after a certain use period the cutting blade should be exchanged for better cutting performance.



catalogue number	pack quantity
058.02.101	1 piece

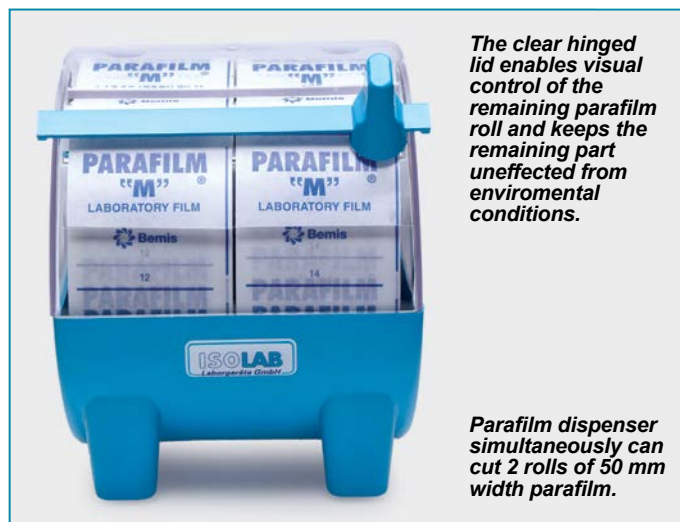

The clear hinged lid enables visual control of the remaining parafilm roll and keeps the remaining part unaffected from environmental conditions.

Parafilm dispenser simultaneously can cut 2 rolls of 50 mm width parafilm.

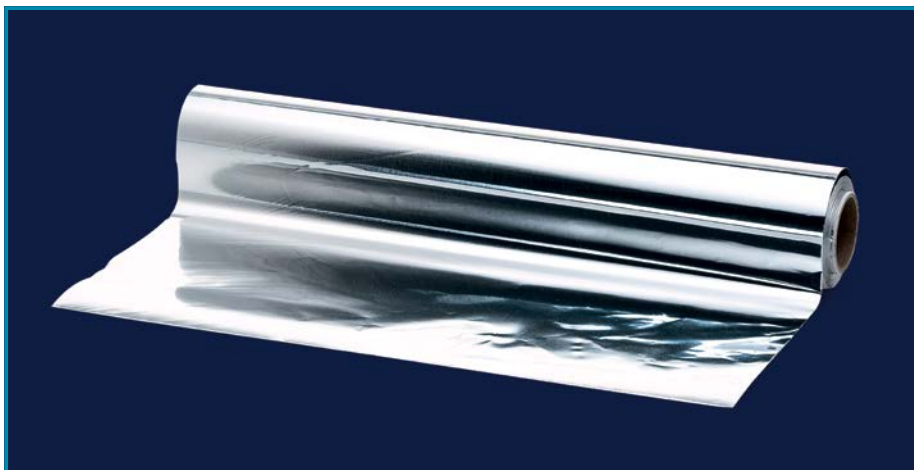

FOIL ROLL - "aluminium"

- Manufactured from polished, pure aluminium sheet for wrapping and sealing of various labware.
- Due to the characteristics also convenient to form temporary containers.
- Offers ideal use during autoclaving, heating, freezing applications.
- Approximate foil thickness is 0,018 mm.

catalogue number	roll width	roll length	pack quantity
058.04.001	300 mm	45 m	1 piece



FOIL DISPENSER

- Perfect dispenser to be used for aluminium folios and cling films.
- Easy and safe to use; Place the roll inside the box, press the lid, pull the necessary length out and start cutting.
- An easy and clean cut without waste is guaranteed with sharp cutting teeth.
- Light weight ensures easy handling with one hand.
- Compact design requires limited working space area.

catalogue number	max. roll width	pack quantity
058.02.002	300 mm	1 piece



ALUMINIUM DISCS

- Manufactured from polished, pure aluminium sheet in circular form for sealing of beakers, erlenmeyers, flasks and other various labware necks.
- Guarantees perfect, dust-free seal and offers ideal use during autoclaving, heating, freezing applications.
- Discs do not stick to each other since they are interleaved with protective tissue papers.
- Approximate foil thickness is 0,03 mm.

Guarantees perfect, dust-free seal and offers ideal use during autoclaving, heating, freezing applications.



catalogue number	diameter	pack quantity
058.05.080	80 mm	1000 pieces
058.05.100	100 mm	1000 pieces
058.05.125	125 mm	1000 pieces
058.05.150	150 mm	1000 pieces

PEN - "engraving"



Easy to operate; hold the pen tightly on the surface, press the power button, let the tip rotate with high speed and provide a permanent inscription on the surface.

- Offers unlimited application for writing, marking and engraving on almost all surfaces without applying pressure.
- Easy to operate; hold the pen tightly on the surface, press the power button, let the tip rotate with high speed and provide a permanent inscription on the surface.
- The inscriptions and markings will not be effected by chemicals or sunshine and stay forever.
- Cordless battery power enables both indoor and outdoor applications. Operates with 2x"AA" battery which is not supplied with the pen.

catalogue
number
099.01.001

pack
quantity
1 piece



PENS - "permanent-ink"- "double tip"

- All purpose pens with round fiber tip for labelling, writing, painting on virtually all materials including glass, metal and plastic surfaces.
- Consists of 2 tips at each end. The "fine" tip at one end has 0,6 mm stroke. The "medium" tip at the other hand has 1,5 mm stroke.
- The pen ink is odorless, smudge-proof, and quick drying. Tips do not dry even if left uncapped for prolonged hours.



Supplied as a pack of 3 pens with red, blue and black colors.

catalogue
number
099.01.002

pack
quantity
set of 3 pens

PENS - "marker"- "double tip"

- All purpose pens with flat fiber tip for marking texts on paper.
- Consists of 2 tips at each end. The "fine" tip at one end has 0,9 mm stroke. The "medium" tip at the other hand has 2,7 mm stroke.
- Airtight pen cap prevents air flow and for extended life cycle.
- Supplied as a pack of 5 pens with purple, blue, green, pink and yellow colors.



Supplied as a pack of 5 pens with purple, blue, green, pink and yellow colors.

catalogue
number
099.01.006

pack
quantity
set of 5 pens



PENS - "permanent-ink"- "single tip"

- All purpose pens with round fiber tip for labelling, writing, painting on virtually all materials including glass, metal and plastic surfaces.
- Consists of a single tip at one end with 3 mm stroke.
- The pen ink is odorless, smudge-proof, and quick drying. Tip do not dry even if left uncapped for prolonged hours.

catalogue
number
099.01.003

pack
quantity
set of 3 pens



Supplied as a pack of 3 pens with blue, red and black colors.

SEALING TAPE - "for petri dishes"



- Perfect tool to protect petri dish interior contents. Stretches and widens up 50% of original length.
- Clings around the petri dish body and seals irregular perimeters of petri dishes.
- Waterproof. Chemically inert and resistant to most organic solvents and caustic agents.
- Remains flexible in moderate freezing temperatures. Can resist up to 100°C.

catalogue number	tape width	pack quantity
058.07.001	19 mm	1 piece

SAFETY LABELS -
"GHS pictograms"

- Designed for easy identification of materials with the universally applicable hazard symbols.
- Manufactured from 100 µm glossy PE film with acrylic resin adhesive back.
- Expands and retracts together with temperature fluctuations and guarantees always a strong adhesive bond.
- Chemically inert, water proof, moisture and most solvents and caustic agents. Can be used between - 20°C to + 80°C temperature range.
- Adheres to any clean surface including PTFE coated surfaces without cracking, peeling and degrading. Peels off without leaving any sticky residue.

product type	signal word	label size 26x37 mm	label size 37x52 mm
GHS 1	warning	099.11.001	099.11.003
GHS 1	danger	099.11.002	099.11.004
GHS 2	warning	099.12.001	099.12.003
GHS 2	danger	099.12.002	099.12.004
GHS 3	warning	099.13.001	099.13.003
GHS 3	danger	099.13.002	099.13.004
GHS 4	warning	099.14.001	099.14.003
GHS 5	warning	099.15.001	099.15.003
GHS 5	danger	099.15.002	099.15.004
GHS 6	danger	099.16.002	099.16.004
GHS 7	warning	099.17.001	099.17.003
GHS 8	warning	099.18.001	099.18.003
GHS 8	danger	099.18.002	099.18.004
GHS 9	warning	099.19.001	099.19.003

By using GHS pictograms you can label all dangerous and hazardous products in your lab and avoid injuries.

"DANGER" word indicates a hazardous situation which if, not avoided will result in death or serious injury.

"WARNING" word indicates a hazardous situation which if, not avoided will result in serious injury.

- Each pictogram is defined with four (German / English / French / Spanish) languages. Supplied as rolls of 250 stickers packed in a dispenser box for practical use.



GHS 01
explosive
warning
danger



GHS 02
flame
warning
danger



GHS 03
oxidizing
warning
danger



GHS 04
gas cylinder
warning



GHS 05
corrosive
warning
danger



GHS 06
toxicity
danger



GHS 07
irritation
warning



GHS 08
health hazardous
warning
danger



GHS 09
environment hazardous
warning

SEALING TAPE - "reinforced"



1- Reinforced Kraft Paper tape: With reinforced layer with fiberglass lamination for excellent resistance to abrasion while transporting. Can adhere to any surface due to the strong adhesive back surface. Suitable for heavy duty packaging, bundling etc.

2- Reinforced Aluminium tape: Made with layers of aluminum, fiberglass yarn and Kraft paper. Resistant to U.V degradation, flame, moisture, many chemicals. Can adhere to any surface due to the strong adhesive back surface. Also suitable for heat/cold reflective wrap along or over insulation, wrapping any product for protection against heat, water, dust and chemicals.

catalogue number	tape name	tape width	tape length	pack quantity
099.04.004	Kraft	60 mm	50 mt	1 roll
099.04.005	Aluminum	50 mm	20 mt	1 roll



CUTTING TOOL - "for tapes"

- A practical cutting tool for all mentioned tapes in this page.

- Practical to use. Easy to handle. Just place the tape in position and start using immediately.

catalogue number	pack quantity
099.04.001	1 piece

TAPES - "for labelling" - "roll"

- Manufactured from colored paper with special resin adhesive that resists to moisture and most solvents.
- Can be used between -5°C to + 110°C temperature range. Also with stands steam autoclaving cycle and gamma irradiation.
- Adheres to any clean surface including PTFE coated surfaces and peels off without leaving any sticky residue.
- Accepts writing from almost all pen types such as pencil, ball point pen, solvent ink marker etc.
- Markings remain absolutely legible under the most demanding laboratory conditions.
- Supplied as white color or as "rainbow pack" pack of 6 different colors matching the universal hazard color codes. (yellow for chemical reactivity / blue for health hazards / green for safety / red for flammability / orange tape for biohazard and white for general purpose.)

catalogue number	tape width	tape length	tape color	box quantity
099.02.001	19 mm	30 meter	rainbow colors	set of 6 rolls
099.02.011	19 mm	30 meter	white	1 roll

TAPE DISPENSER

- Suitable for holding and releasing the tape to be cut to users desire.
- The core perfectly fits to the inner diameter of the tape and keeps the tape rigidly.
- Platform includes a writing surface. Finger holes on the platform enable quick release of the tape and accelerate the cutting step.
- Featured with a cut-off edge for efficient cutting of the tape.
- A weighted base with non-skid pads prevent sliding or lifting.
- Over all dimensions: 155x250x100 mm.
- Cutting platform dimensions: 155x110 mm.

catalogue number	pack quantity
099.02.002	1 piece

LABELS - "rectangular form"

- Manufactured from polypropylene flexible paper with acrylic resin adhesive back.
- This unique combination expands and retracts together with temperature fluctuations and guarantees always a strong adhesive bond.
- Chemically inert, resists to water, moisture and most organic solvents and caustic agents. Can be used between -96°C to +121°C temperature range. Also withstands steam autoclaving cycle and gamma irradiation.
- Adheres to any clean surface including PTFE coated surfaces without cracking, peeling and degrading. Peels off without leaving any sticky residue.

catalogue number	label length	label width	label color	roll quantity	pack quantity
099.03.050	30 mm	50 mm	white	1000 labels	1 roll
099.03.072	72 mm	40 mm	white	1000 labels	1 roll
099.03.090	90 mm	50 mm	white	1000 labels	1 roll

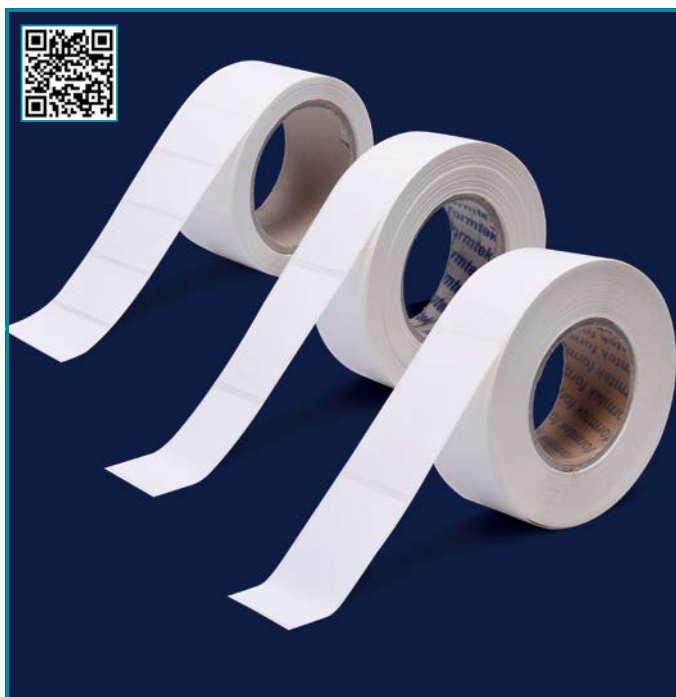
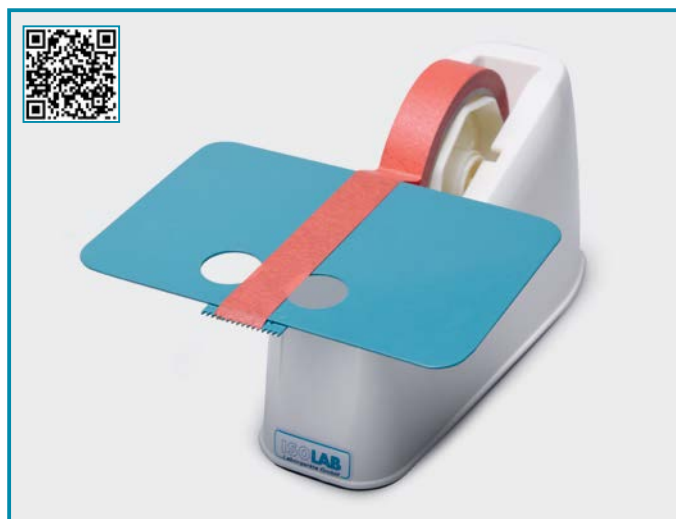
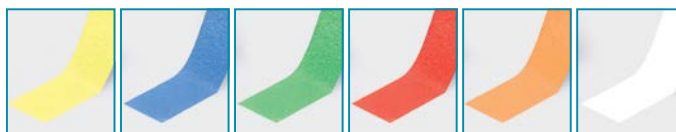



LABEL - "circular form"

- ▶ Manufactured from polyfiber grade flexible paper with acrylic resin adhesive back.
- ▶ This unique combination expands and retracts together with temperature fluctuations and guarantees always a strong adhesive bond.
- ▶ Chemically inert, resists to water, moisture and most organic solvents and caustic agents. Can be used between -196°C to +80°C temperature range.
- ▶ Adheres to any clean surface including PTFE coated surfaces without cracking, peeling and degrading. Peels off without leaving any sticky residue.
- ▶ Recommended to be used on tube caps with different diameters. Supplied as rolls packed in a dispenser box for practical use.
- ▶ Supplied as white color or as "rainbow pack" pack of 6 different colors matching the universal hazard color codes. (yellow for chemical reactivity / blue for health hazards / green for safety / red for flammability / orange tape for biohazard and white for general purpose.)



catalogue number	label diameter	recommended for	label color	roll quantity	pack quantity
099.05.009	9,5 mm	0,5 ml tubes	white	1000 labels	1 roll
099.05.109	9,5 mm	0,5 ml tubes	rainbow pack	1000 labels	6 rolls
099.05.013	13 mm	1,5 & 2,0 ml tubes	white	1000 labels	1 roll
099.05.113	13 mm	1,5 & 2,0 ml tubes	rainbow pack	1000 labels	6 rolls
099.05.019	19 mm	15 ml tubes	white	500 labels	1 roll
099.05.025	25 mm	50 ml tubes	white	500 labels	1 roll



LABEL DISPENSER

- ▶ Perfect organizer for fast and efficient use of labels. Manufactured from clear acrylic and holds 6 label box.
- ▶ Drop the label box in the label dispenser and feed the paper through the slot.
- ▶ The writing surface enables easy and clean writing on the label. The sharp cutting edge helps to tear off the labels.
- ▶ A weighted base with non-skid pads prevent sliding or lifting.
- ▶ Supplied without pen.

catalogue number	pack quantity
099.50.001	1 piece



LABEL REMOVAL

- ▶ A perfect tool for effortless removal self adhesive labels.
- ▶ It works on the adhesive and quickly and gently dissolves adhesive of the label without leaving the sticky residue of the adhesive on the surface.
- ▶ Can be used on glass, porcelain, metal, wood, cardboard and some plastic surfaces.
- ▶ Not recommended to be used with polystyrene.

catalogue number	pack quantity
099.60.001	1 piece



LABELS - "rectangular form"

- Manufactured from polyfiber grade flexible paper with acrylic resin adhesive back.
- This unique combination expands and retracts together with temperature fluctuations and guarantees always a strong adhesive bond.
- Chemically inert, resists to water, moisture and most organic solvents and caustic agents.
- Can be used between -40°C to +121°C temperature range.
- Also withstands steam autoclaving cycle and gamma irradiation.
- Adheres to any clean surface including PTFE coated surfaces without cracking, peeling and degrading. Peels off without leaving any sticky residue.
- Recommended to be used on flat or round surfaces with different diameters.
- Supplied as 1000 label rolls packed in a dispenser box for practice use.

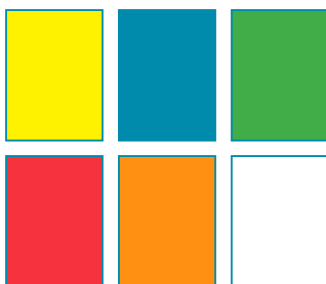

"rainbow pack offers 6 colors"

catalogue number	label dimensions	recommended tube volume	label color	pack quantity
099.06.024	24x13 mm	0,5 ml	white	1 roll
099.06.124	24x13 mm	0,5 ml	rainbow pack	6 rolls
099.06.033	33x13 mm	1,5 & 2,0 ml	white	1 roll
099.06.133	33x13 mm	1,5 & 2,0 ml	rainbow pack	6 rolls
099.06.038	38x19 mm	general purpose	white	1 roll

Supplied as white color or as "rainbow pack" pack of 6 different colors matching the universal hazard color codes. (yellow for chemical reactivity / blue for health hazards / green for safety / red for flammability / orange tape for biohazard and white for general use).



LABELS - "rectangular form"

- Manufactured from polyfiber grade flexible paper with acrylic resin adhesive back.
- This unique combination expands and retracts together with temperature fluctuations and guarantees always a strong adhesive bond.
- Chemically inert, resists to water, moisture and most organic solvents and caustic agents.
- Can be used between -196°C to +80°C temperature range.
- Also with stands gamma irradiation.
- Adheres to any clean surface including PTFE coated surfaces without cracking, peeling and degrading. Peels off without leaving any sticky residue.
- Recommended specially to be used with cryo vials or on any flat or round surface.
- Supplied as 1000 label rolls packed in a dispenser box for practice use.

catalogue number	label dimensions	recommended tube volume	label color	pack quantity
099.07.033	33x13 mm	1,5 & 2,0 ml	white	1 roll
099.07.038	38x19 mm	general purpose	white	1 roll

GHS pictograms can be selected from catalogue page no 74.





BAGS - "autoclavable" - "plain"

- Manufactured from a special grade of polypropylene with high tear and puncture resistance.
- Commonly used for safe disposal of contaminated laboratory waste such as used petri dishes, test tubes, sample vials, cultureware and other biohazardous products.
- Also offers an alternative for storing and transportation of various products.
- Can resist pressure differences during autoclaving.
- Bags should be left open during autoclaving.
- Strong side seams stand safe under pressure or weight and guarantee safe holding of bag content.

catalogue number	bag type	width x height	pack quantity
039.30.001	plain	200 x 300 mm	100 pieces / pack
039.30.002	plain	300 x 600 mm	100 pieces / pack
039.30.003	plain	400 x 700 mm	100 pieces / pack
039.30.004	plain	590 x 890 mm	100 pieces / pack
039.30.005	plain	690 x 1100 mm	100 pieces / pack



BAGS - "autoclavable" - "imprinted"

- Manufactured from a special grade of polypropylene with high tear and puncture resistance.
- Commonly used for safe disposal of contaminated laboratory waste such as used petri dishes, test tubes, sample vials, cultureware and other biohazardous products.
- Also offers an alternative for storing and transportation of various products.
- Can resist pressure differences during autoclaving.
- Bags should be left open during autoclaving.
- Strong side seams stand safe under pressure or weight and guarantee safe holding of bag content
- On the bag surface a large writing area and necessary warnings are imprinted.

catalogue number	bag type	width x height	pack quantity
039.20.001	imprinted	320 x 640 mm	50 pieces / pack
039.20.002	imprinted	420 x 600 mm	50 pieces / pack
039.20.003	imprinted	555 x 745 mm	50 pieces / pack



BAG STAND "adjustable height"

- Manufactured from stainless steel for use with the bags with catalogue no **039.30.001**.
- Ideal for disposal of small objects during daily use at laboratories.
- Due to it's compact size bag stand does not cover space on the laboratory bench.
- The height of the stand is adjustable with the help of adjusting screw.

catalogue number	stand diameter	pack quantity
062.30.002	125 ± 5 mm	1 piece





BAGS - "with wire closure" - "sterile"

- Manufactured from clear and thick polyethylene to be used with chemical, medical, food, biological samples of liquid, powder, solid and paste form.
- With their exceptionally transparent, odour-tight, tear-proof and leakproof properties they offer alternative solutions to laboratory bottles and other flasks.
- Sterilized with gamma irradiation, **free of RNase, DNase, and pyrogene**. Can be frozen to -80°C.
- Unique metal closure system guarantees leak-proof closure preventing odors and any leakage to exterior environment.
- Write-on white patch offers a practical area for writing specific marks and notes.

catalogue number	volume	width x height	wall thickness	wire thickness	packing specifications
039.21.001	60 ml	76 x 127 mm	70 microns	0,5 mm	500 pcs / pack - 1000 pcs / case
039.21.002	120 ml	76 x 178 mm	70 microns	0,5 mm	500 pcs / pack - 1000 pcs / case
039.21.003	540 ml	114 x 229 mm	70 microns	0,5 mm	500 pcs / pack - 1000 pcs / case
039.21.004	720 ml	140 x 229 mm	90 microns	0,5 mm	500 pcs / pack - 1000 pcs / case
039.21.005	1650 ml	180 x 300 mm	100 microns	0,5 mm	250 pcs / pack - 1000 pcs / case



BAGS - "with zip-lock" - "with write - on patch"

- Manufactured from clear and robust polyethylene to be used with chemical, medical, food, biological samples of liquid, powder, solid and paste form.
- Non-sterile, ideal for dust-free storing, collecting, protecting and shipping of specimens and samples.
- Write - on white patch offers a practical area for writing specific marks and notes.
- Rim channel seal can be opened and closed repeatedly with the guarantee of leak-proof closure.

catalogue number	w x L (mm)	pack quantity
039.08.100	70x100	100 pieces
039.08.150	100x150	100 pieces
039.08.220	150x220	100 pieces
039.08.300	200x300	100 pieces



BAG LOCKS

- Manufactured from a special grade of polypropylene for quick closing of the bags.
- Unique design enables damage free opening and multiple use of the same bag lock.

Offers very tight sealing of the bags. Can be opened again once closed.



catalogue number	length	width	pack quantity
039.34.105	105 mm	2,5 mm	100 pieces
039.34.150	150 mm	2,5 mm	100 pieces



BAG LATCHES

- Manufactured from a special grade of polypropylene for quick closing of the bags. Practical closing system guarantees perfect and tight closure of the bags.

catalogue number	length	width	pack quantity
039.35.075	75 mm	15 mm	4 pieces
039.35.145	145 mm	15 mm	4 pieces
039.35.200	200 mm	15 mm	4 pieces

lab consumables & labware

BAGS - "homogenization" - "sterile"

- Manufactured from polyethylene. Specially designed for fast and effective crushing of solid samples to the liquid phase.
- Sterilized with gamma irradiation, **free of RNase, DNase, and pyrogene.**
- Even at low temperatures they maintain the stability of the specimen's microbiological status.
- While working with infectious samples, bags can be sealed by any ordinary bag sealer to prevent the escape of aerosols.
- **Alternative 3 products:**
 - Bag without filter
 - Bag with side filter
 - Bag with full filter

bag with no filter



Bags without filter are generally used for standard and common practises.

bag with side (lateral) filter



Bags with side (lateral) filter divides the bag in 2 non-equal compartments. They are suitable for small samples such as PCR applications.

bag with full (page) surface filter



Bags with full (page) filter divides in 2 equal compartments. Solid sample remains in it's side, while the liquid phase moves to the other side.

catalogue number	bag type	volume	width x height	wall thickness	pore size	packing specifications
039.23.003	no filter	400 ml	190 x 300 mm	70 microns	-	50 pcs / pack - 500 pcs / case
039.23.002	side filter	400 ml	190 x 300 mm	70 microns	< 250 microns	50 pcs / pack - 500 pcs / case
039.23.001	full filter	400 ml	190 x 300 mm	70 microns	< 280 microns	50 pcs / pack - 500 pcs / case

ACCESSORIES - "for homogenization bags"

➤ **BAG STAND - "stainless steel"**: Manufactured from AISI 304 grade stainless steel for hanging homogenization bags.

➤ Can carry 4 homogenisation bags of any type.

catalogue number	pack quantity
608.01.101	1 piece

➤ **BAG STAND - "acrylic"**: Manufactured durable acrylic for hanging homogenisation bags.

➤ Can carry 10 homogenisation bags of any type.

catalogue number	pack quantity
608.01.102	1 piece

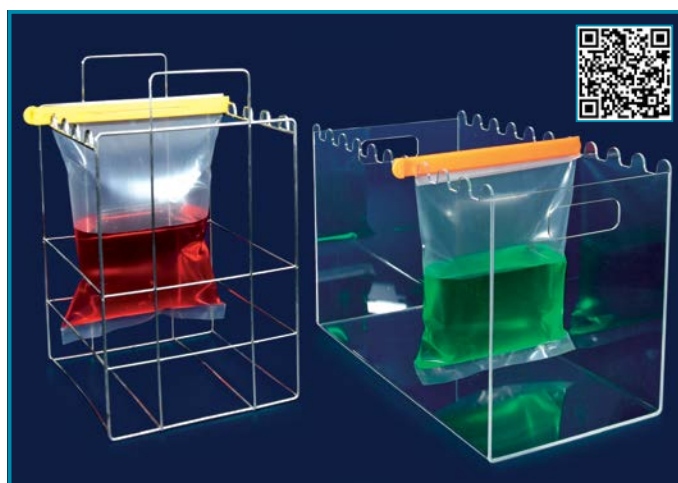

BAG LATCHES

➤ **BAG LATCHES**: Manufactured from a special grade of polypropylene for quick closing of the bags. Practical closing system guarantees perfect and tight closure of the bags.

➤ Color coded in 4 different colors for fast and easy identification.

catalogue number	pack quantity
039.35.200	set of 4





ISOLAB
Laborgeräte GmbH



*distillation & filtration
separation
sample preparation*



distillation & filtration & separation & sample preparation

GROUND JOINTS - "socket"



- ▶ Manufactured from heat resistant, durable borosilicate glass according to DIN 12249 standard with 120 mm length.
- ▶ Excellent grinding quality prevents airleaks and liquid leakage.

catalogue number	joint NS size	pack quantity
063.01.010	10/19	1 piece
063.01.012	12/21	1 piece
063.01.014	14/23	1 piece
063.01.019	19/26	1 piece
063.01.024	24/29	1 piece
063.01.029	29/32	1 piece
063.01.034	34/35	1 piece
063.01.045	45/40	1 piece

GROUND JOINTS - "cone"



- ▶ Manufactured from heat resistant, durable borosilicate glass according to DIN 12249 standard with 120 mm length.
- ▶ Excellent grinding quality prevents airleaks and liquid leakage.

catalogue number	joint NS size	pack quantity
063.02.010	10/19	1 piece
063.02.012	12/21	1 piece
063.02.014	14/23	1 piece
063.02.019	19/26	1 piece
063.02.024	24/29	1 piece
063.02.029	29/32	1 piece
063.02.034	34/35	1 piece
063.02.045	45/40	1 piece

ADAPTERS - "expansion"



- ▶ Manufactured from heat resistant, durable borosilicate glass according to DIN 12257 standard with socket size larger than cone size.

catalogue number	cone NS	socket NS	pack quantity
064.11.001	12/21	14/23	1 pc.
064.11.002	14/23	19/26	1 pc.
064.11.003	14/23	24/29	1 pc.
064.11.004	19/26	24/29	1 pc.
064.11.005	14/23	29/32	1 pc.
064.11.006	19/26	29/32	1 pc.
064.11.007	24/29	29/32	1 pc.
064.11.008	19/26	34/35	1 pc.
064.11.009	24/29	34/35	1 pc.
064.11.010	29/32	34/35	1 pc.
064.11.011	24/29	45/40	1 pc.
064.11.012	29/32	45/40	1 pc.

ADAPTERS - "reduction"



- ▶ Manufactured from heat resistant, durable borosilicate glass according to DIN 12257 standard with socket size smaller than cone size.

catalogue number	cone NS	socket NS	pack quantity
064.12.001	14/23	12/21	1 pc.
064.12.002	19/26	14/23	1 pc.
064.12.003	24/29	14/23	1 pc.
064.12.004	29/32	14/23	1 pc.
064.12.005	24/29	19/26	1 pc.
064.12.006	29/32	19/26	1 pc.
064.12.007	34/35	19/26	1 pc.
064.12.008	29/32	24/29	1 pc.
064.12.009	34/35	24/29	1 pc.
064.12.010	45/40	24/29	1 pc.
064.12.011	34/35	29/32	1 pc.
064.12.012	45/40	29/32	1 pc.

ADAPTERS - "with screw thread"



- ▶ Manufactured from heat resistant, durable borosilicate glass according to DIN 12257 standard.
- ▶ Excellent grinding quality prevents airleaks and liquid leakage.
- ▶ Different thread sizes offer multiple tubing connection options.

catalogue number	joint NS size	neck thread	pack quantity
065.19.141	14/23	GL 14	1 pc.
065.19.142	14/23	GL 18	1 pc.
065.19.291	29/32	GL 14	1 pc.
065.19.292	29/32	GL 18	1 pc.
065.19.293	29/32	GL 25	1 pc.

ADAPTERS - "with screw thread & cap"



- ▶ Manufactured from heat resistant, durable borosilicate glass according to DIN 12257 standard.
- ▶ Excellent grinding quality prevents airleaks and liquid leakage.
- ▶ Supplied with a screw cap with hole featured with silicone sealing.
- ▶ Provides easy adjustment of thermometer height position.

catalogue number	joint NS size	neck thread	pack quantity
065.21.014	14/23	GL 14	1 pc.
065.21.029	29/32	GL 14	1 pc.

distillation & filtration & separation & sample preparation

ADAPTERS - "straight"



- Manufactured from heat resistant, durable borosilicate glass featured with a straight tubing adapter.
- Excellently grinded joint prevents airleaks and leakage.
- Tubing adapter fits tubings with 6-10 mm diameter.

catalogue number	joint NS size	pack quantity
065.26.014	14/23	1 piece
065.26.029	29/32	1 piece

ADAPTERS - "straight" - "with stopcock"



- Manufactured from borosilicate 3.3 with a straight adapter and a PTFE stopcock.
- Excellently grinded joint prevents airleaks and leakage.
- Tubing adapter fits tubings with 6-10 mm diameter.

catalogue number	joint NS size	pack quantity
065.28.014	14/23	1 piece
065.28.029	29/32	1 piece

ADAPTERS - "bend"



- Manufactured from heat resistant, durable borosilicate glass featured with a 90° angle bend tubing adapter.
- Excellently grinded joint prevents airleaks and leakage.
- Tubing adapter fits tubings with 6-10 mm diameter.

catalogue number	joint NS size	pack quantity
065.27.014	14/23	1 piece
065.27.029	29/32	1 piece

ADAPTERS - "bend" - "with stopcock"



- Manufactured from heat resistant, durable borosilicate glass with a 90° bend tubing adapter and a PTFE stopcock.
- Excellently grinded joint prevents airleaks and leakage.
- Tubing adapter fits tubings with 6-10 mm diameter.

catalogue number	joint NS size	pack quantity
065.29.014	14/23	1 piece
065.29.029	29/32	1 piece

ADAPTERS - "straight"



- Manufactured from heat resistant, durable borosilicate glass featured with a straight tubing adapter.
- Excellently grinded joint prevents airleaks and leakage.
- Tubing adapter fits tubings with 6-10 mm diameter.

catalogue number	joint NS size	pack quantity
065.22.014	14/23	1 piece
065.22.029	29/32	1 piece

ADAPTERS - "straight" - "with stopcock"



- Manufactured from heat resistant, durable borosilicate glass featured with a straight tubing adapter and a PTFE stopcock.
- Excellently grinded joint prevents airleaks and leakage.
- Tubing adapter fits tubings with 6-10 mm diameter.

catalogue number	joint NS size	pack quantity
065.24.014	14/23	1 piece
065.24.029	29/32	1 piece

ADAPTERS - "bend"



- Manufactured from heat resistant, durable borosilicate glass featured with a 90° angle bend tubing adapter.
- Excellently grinded joint prevents airleaks and leakage.
- Tubing adapter fits tubings with 6-10 mm diameter.

catalogue number	joint NS size	pack quantity
065.23.014	14/23	1 piece
065.23.029	29/32	1 piece

ADAPTERS - "bend" - "with stopcock"



- Manufactured from heat resistant, durable borosilicate glass with a 90° angle bend tubing adapter and a PTFE stopcock.
- Excellently grinded joint prevents airleaks and leakage.
- Tubing adapter fits tubings with 6-10 mm diameter.

catalogue number	joint NS size	pack quantity
065.25.014	14/23	1 piece
065.25.029	29/32	1 piece

distillation & filtration & separation & sample preparation

ADAPTERS - "bend" - "75° angle"



► Manufactured from heat resistant, durable borosilicate glass 75° angle bend and featured with two cones on both ends.

► Excellently grinded cones prevent airleaks and liquid leakage.

catalogue number	joint NS size	pack quantity
065.37.014	14/23	1 piece
065.37.029	29/32	1 piece

ADAPTERS - "bend" - "90° angle"



► Manufactured from heat resistant, durable borosilicate glass 90° angle bend and featured with two cones on both ends.

► Excellently grinded cones prevent airleaks and liquid leakage.

catalogue number	joint NS size	pack quantity
065.38.014	14/23	1 piece
065.38.029	29/32	1 piece

ADAPTERS - "2 necks" - "45° upwards angled"



► Manufactured from heat resistant, durable borosilicate glass featured with a 45° upwards angled socket.

► Excellently grinded joints prevent airleaks and liquid leakage.

catalogue number	socket NS size	cone NS size	angled socket NS size	pack quantity
065.42.001	NS 14/23	NS 14/23	NS 14/23	1 piece
065.42.002	NS 19/26	NS 19/26	NS 19/26	1 piece
065.42.003	NS 29/32	NS 29/32	NS 14/23	1 piece
065.42.004	NS 29/32	NS 29/32	NS 29/32	1 piece

ADAPTERS - "2 necks" - "75° downwards angled"



► Manufactured from heat resistant, durable borosilicate glass featured with a 75° downwards angled socket.

► Excellently grinded joints prevent airleaks and liquid leakage.

catalogue number	socket NS size	cone NS size	angled socket NS size	pack quantity
065.18.001	NS 14/23	NS 14/23	NS 14/23	1 piece
065.18.002	NS 19/26	NS 19/26	NS 19/26	1 piece
065.18.003	NS 29/32	NS 29/32	NS 14/23	1 piece
065.18.004	NS 29/32	NS 29/32	NS 29/32	1 piece

ADAPTERS - "2 necks" - "parallel"



► Manufactured from heat resistant, durable borosilicate glass featured with a parallel socket.

► Excellently grinded joints prevent airleaks and liquid leakage.

catalogue number	socket NS size	cone NS size	parallel socket NS size	pack quantity
065.43.001	NS 14/23	NS 14/23	NS 14/23	1 piece
065.43.002	NS 19/26	NS 19/26	NS 19/26	1 piece
065.43.003	NS 24/29	NS 19/26	NS 19/26	1 piece
065.43.004	NS 24/29	NS 24/29	NS 24/29	1 piece
065.43.005	NS 29/32	NS 14/23	NS 14/23	1 piece
065.43.006	NS 29/32	NS 29/32	NS 29/32	1 piece

ADAPTERS - "3 necks" - "angled & parallel"



► Manufactured from heat resistant, durable borosilicate glass featured with one parallel and one angled socket.

► Excellently grinded joints prevent airleaks and liquid leakage.

catalogue number	socket NS size	cone NS size	parallel socket NS size	pack quantity
065.44.001	NS 14/23	NS 14/23	NS 14/23	1 piece
065.44.002	NS 19/26	NS 24/29	NS 19/26	1 piece
065.44.003	NS 19/26	NS 29/32	NS 19/26	1 piece
065.44.004	NS 24/29	NS 24/29	NS 24/29	1 piece
065.44.005	NS 29/32	NS 29/32	NS 29/32	1 piece

distillation & filtration & separation & sample preparation

DISTILLING HEADS



▶ Manufactured from heat resistant, durable borosilicate glass according to DIN 12594 standard featured with a 75° downwards angled cone.

▶ NS 14/23 socket is designed to be used with distillation thermometers.

▶ Excellently grinded joints prevent airleaks and liquid leakage.

catalogue number	socket NS size	cone NS size	angled cone NS size	pack quantity
065.45.001	NS 14/23	NS 14/23	NS 14/23	1 piece
065.45.002	NS 14/23	NS 19/26	NS 19/26	1 piece
065.45.005	NS 14/23	NS 29/32	NS 29/32	1 piece

DISTILLING HEADS - "Claisen"



▶ Manufactured from heat resistant, durable borosilicate glass according to DIN 12594 standard featured with a 75° downwards angled cone.

▶ Two parallel NS 14/23 sockets are designed to be used with distillation thermometers.

▶ Excellently grinded joints prevent airleaks and liquid leakage.

catalogue number	socket NS size	cone NS size	angled cone NS size	pack quantity
065.46.001	NS 14/23	NS 14/23	NS 14/23	1 piece
065.46.002	NS 14/23	NS 19/26	NS 19/26	1 piece
065.46.005	NS 14/23	NS 29/32	NS 14/23	1 piece
065.46.006	NS 14/23	NS 29/32	NS 29/32	1 piece

SPLASH HEADS - "straight"



▶ Manufactured from heat resistant, durable borosilicate glass for separation of drops. Advised to be placed directly on top of the distillation flasks.

▶ Excellently grinded joints prevent airleaks and liquid leakage.

catalogue number	cone NS	socket NS	pack quantity
065.47.001	14/23	14/23	1 piece
065.47.003	29/32	29/32	1 piece

SPLASH HEADS - "bend"



▶ Manufactured from heat resistant, durable borosilicate glass 75° angled bend for separation of drops. Advised to be placed directly on top of the distillation flasks.

▶ Excellently grinded joints prevent airleaks and liquid leakage.

catalogue number	cone NS	socket NS	pack quantity
065.48.001	14/23	14/23	1 piece
065.48.005	29/32	29/32	1 piece

ADAPTERS - "delivery" - "straight"



▶ Manufactured from heat resistant, durable borosilicate glass according to DIN 12594 standard with a cone with drain tip.

▶ Featured with a straight socket and a vacuum connecting adapter.

▶ Excellently grinded joints prevent airleaks and liquid leakage.

catalogue number	cone NS	socket NS	pack quantity
065.34.014	14/23	14/23	1 piece
065.34.029	29/32	29/32	1 piece

ADAPTERS - "with stopcock"



▶ Manufactured from heat resistant, durable borosilicate glass according to DIN 12594 standard with a socket with drain tip.

▶ Featured with a straight socket and cone and a PTFE stopcock.

▶ Excellently grinded joints prevent airleaks and liquid leakage.

catalogue number	cone NS	socket NS	pack quantity
065.41.014	14/23	14/23	1 piece
065.41.019	19/26	19/26	1 piece
065.41.024	24/29	24/29	1 piece
065.41.029	29/32	29/32	1 piece

distillation & filtration & separation & sample preparation

DISTILLING LINKS



► Manufactured from heat resistant, durable borosilicate glass without condenser with two parallel cones.

► Excellently grinded joints prevent airleaks and liquid leakage.

catalogue number	cone NS size	cone NS size	pack quantity
065.52.014	NS 14/23	NS 14/23	1 piece
065.52.029	NS 29/32	NS 29/32	1 piece

DISTILLING LINKS - "with splash head"



► Manufactured from heat resistant, durable borosilicate glass with a splash head and with two parallel cones.

► Excellently grinded joints prevent airleaks and liquid leakage.

catalogue number	cone NS size	cone NS size	pack quantity
065.54.014	NS 14/23	NS 14/23	1 piece
065.54.029	NS 29/32	NS 29/32	1 piece

DISTILLING LINKS - "with socket"



► Manufactured from heat resistant, durable borosilicate glass without condenser with two parallel cones. NS 14/23 socket is designed to be used with distillation thermometers.

► Excellently grinded joints prevent airleaks and liquid leakage.

catalogue number	cone NS size	cone NS size	socket NS size	pack quantity
065.53.014	NS 14/23	NS 14/23	NS 14/23	1 piece
065.53.029	NS 29/32	NS 29/32	NS 29/32	1 piece

DISTILLING LINKS - "with condenser"



► Manufactured from heat resistant, durable borosilicate glass with a liebig condenser with a NS 14/23 socket is designed to be used with distillation thermometers.

► Excellently grinded joints prevent airleaks and liquid leakage.

catalogue number	cone NS size	socket NS size	condenser length	pack quantity
065.55.001	NS 14/23	NS 14/23	160 mm	1 piece
065.55.002	NS 14/23	NS 14/23	250 mm	1 piece
065.55.003	NS 29/32	NS 14/23	250 mm	1 piece
065.55.004	NS 29/32	NS 14/23	400 mm	1 piece

DISTILLING LINKS - "condenser & adapter"



► Manufactured from heat resistant, durable borosilicate glass with a liebig condenser with a NS 14/23 socket is designed to be used with distillation thermometers. Featured with a vacuum connecting adapter.

► Excellently grinded joints prevent airleaks and liquid leakage.

catalogue number	cone NS size	socket NS size	condenser length	pack quantity
065.56.001	NS 14/23	NS 14/23	160 mm	1 piece
065.56.002	NS 14/23	NS 14/23	250 mm	1 piece
065.56.003	NS 29/32	NS 14/23	250 mm	1 piece
065.56.004	NS 29/32	NS 14/23	400 mm	1 piece

distillation & filtration & separation & sample preparation

DISTILLING LINKS - "with condenser" - "Claisen head"

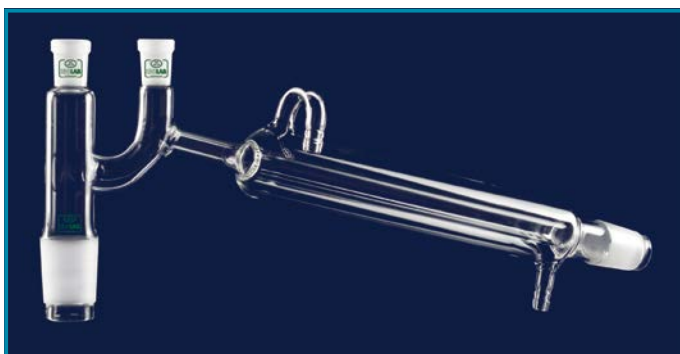

► Manufactured from heat resistant, durable borosilicate glass with a liebig condenser with two NS 14/23 socket is designed to be used with distillation thermometers.

► Excellently grinded joints prevent airleaks and liquid leakage.

catalogue number	cone NS size	socket NS size	condenser length	pack quantity
065.57.001	NS 14/23	NS 14/23	160 mm	1 piece
065.57.002	NS 14/23	NS 14/23	250 mm	1 piece
065.57.003	NS 29/32	NS 14/23	250 mm	1 piece
065.57.004	NS 29/32	NS 14/23	400 mm	1 piece

DISTILLING LINKS - "with condenser & vacuum adapter" - "Claisen head"



► Manufactured from heat resistant, durable borosilicate glass with a liebig condenser with two NS 14/23 socket is designed to be used with distillation thermometers. Featured with a vacuum connecting adapter.

► Excellently grinded joints prevent airleaks and liquid leakage.

catalogue number	cone NS size	socket NS size	condenser length	pack quantity
065.58.001	NS 14/23	NS 14/23	160 mm	1 piece
065.58.002	NS 14/23	NS 14/23	250 mm	1 piece
065.58.003	NS 29/32	NS 14/23	250 mm	1 piece
065.58.004	NS 29/32	NS 14/23	400 mm	1 piece

ADAPTERS - "PTFE" - "flexible"



► Manufactured from chemically inert PTFE with excellent chemical resistance, high mechanical strength and high temperature resistance between -200°C to +260°C.

► Unique flexible body form guarantees 90° angular connections of NS joints and provides corrections of misalignment in glassware assemblies.

► Extra smooth interior finish guarantees high vacuum sealing performance without a need of any lubricant.

catalogue number	socket NS size	cone NS size	pack quantity
065.36.014	NS 14/23	NS 14/23	1 piece
065.36.019	NS 19/26	NS 19/26	1 piece
065.36.024	NS 24/29	NS 24/29	1 piece
065.36.029	NS 29/32	NS 29/32	1 piece

GLASS BEADS



► Manufactured from borosilicate glass.

► They offer practical solutions specially for distillation applications with their different diameters.

catalogue number	diameter (mm)	pack quantity
030.60.003	3,0 - 3,5	1 kg
030.60.004	3,5 - 4,0	1 kg
030.60.005	4,0 - 5,0	1 kg
030.60.006	5,0 - 6,0	1 kg

distillation & filtration & separation & sample preparation

ADAPTERS - "delivery" - "bend" - "short"



- Manufactured from heat resistant, durable borosilicate glass with 65 mm length.
- Featured with a 105° angled bend socket.
- Excellently grinded joint prevents airleaks and liquid leakage.

catalogue number	socket NS size	pack quantity
065.30.014	14/23	1 piece
065.30.029	29/32	1 piece

ADAPTERS - "delivery" - "bend" - "long"



- Manufactured from heat resistant, durable borosilicate glass with 200 mm length.
- Featured with a 105° angled bend socket.
- Excellently grinded joint prevents airleaks and liquid leakage.

catalogue number	socket NS size	pack quantity
065.31.014	14/23	1 piece
065.31.029	29/32	1 piece

ADAPTERS - "delivery" - "bend"



- Manufactured from heat resistant, durable borosilicate glass featured with a cone and a socket with drain tip.
- Featured with a 105° angled bend socket.
- Excellently grinded joints prevent airleaks and liquid leakage.

catalogue number	cone NS	socket NS	pack quantity
065.32.014	14/23	14/23	1 piece
065.32.029	29/32	29/32	1 piece

ADAPTERS - "delivery" - "bend" - "with ventilation"



- Manufactured from heat resistant, durable borosilicate glass featured with a cone and a socket with drain tip.
- Featured with a 105° angled bend socket and with ventilation arm useful to be used with highly boiling liquids.
- Excellently grinded joints prevent airleaks and liquid leakage.

catalogue number	cone NS	socket NS	pack quantity
065.33.014	14/23	14/23	1 piece
065.33.029	29/32	29/32	1 piece

ADAPTERS - "receiving" - "straight"



- Manufactured from heat resistant, durable borosilicate glass according to DIN 12594 standard with a cone with drain tip.
- Featured with a straight cone and a vacuum connecting adapter.
- Excellently grinded joints prevent airleaks and liquid leakage.

catalogue number	cone NS	socket NS	pack quantity
065.39.014	14/23	14/23	1 piece
065.39.029	29/32	29/32	1 piece

ADAPTERS - "receiving" - "bend"



- Manufactured from heat resistant, durable borosilicate glass according to DIN 12594 standard with a cone with drain tip.
- Featured with a bend cone and a vacuum connecting adapter.
- Excellently grinded joints prevent airleaks and liquid leakage.

catalogue number	cone NS	socket NS	pack quantity
065.40.014	14/23	14/23	1 piece
065.40.029	29/32	29/32	1 piece

distillation & filtration & separation & sample preparation

DRYING TUBES - "bend"



- ▶ Manufactured from heat resistant, durable borosilicate glass according to DIN 12610 standard with a ball and connection tube.

catalogue number	pack quantity
065.60.100	1 piece
065.60.150	1 piece

DRYING TUBES - "U form"



- ▶ Manufactured from heat resistant, durable borosilicate glass with a U form.

catalogue number	pack quantity
065.62.100	1 piece
065.62.130	1 piece
065.62.180	1 piece

DRYING TUBES - "U form" - "with stopcock"



- ▶ Manufactured from heat resistant, durable borosilicate glass according to DIN 12610 standard with a U form and featured with a stopcock.

catalogue number	pack quantity
065.63.100	1 piece
065.63.130	1 piece
065.63.180	1 piece

BOTTLES - "gas washing"



- ▶ Manufactured from borosilicate 3.3 with thick walls with NS 29/32 neck size.

- ▶ Supplied without the bottle heads.

catalogue number	bottle volume	pack quantity
065.66.125	125 ml	1 piece
065.66.250	250 ml	1 piece
065.66.500	500 ml	1 piece
065.66.901	1000 ml	1 piece

BOTTLE HEAD - "glass side arm" - "without disc"



- ▶ Manufactured from heat resistant, durable borosilicate glass without sintered glass support.

- ▶ Featured with a glass side arm.

catalogue number	pack quantity
065.67.001	1 piece

BOTTLE HEAD - "glass side arm" - "with disc"



- ▶ Manufactured from heat resistant, durable borosilicate glass with sintered glass support.

- ▶ Featured with a glass side arm.

- ▶ Sintered glass disc with porosity 1 for efficient gas dispensing.

catalogue number	pack quantity
065.67.011	1 piece

BOTTLE HEAD - "PP side arm" - "without disc"



- ▶ Manufactured from heat resistant, durable borosilicate glass without sintered glass support.

- ▶ Featured with with GL 14 screw thread polypropylene side arm which can easily connected or disconnected preventing accidental breakage.

catalogue number	pack quantity
065.67.002	1 piece

BOTTLE HEAD - "PP side arm" - "with disc"



- ▶ Manufactured from heat resistant, durable borosilicate glass with sintered glass support.

- ▶ Sintered glass disc with porosity 1 enables efficient gas dispensing

- ▶ Featured with with GL 14 screw thread polypropylene side arms.

catalogue number	pack quantity
065.67.022	1 piece

distillation & filtration & separation & sample preparation

CHEMISTRY SET

- Set consists of 16 pieces various small size glassware with NS 14/23 joints.
- Allows multi micro experiments under vacuum or atmospheric pressure.
- Supplied in a sturdy plastic case featured with foam inserts. Foam inserts prevent breakage and allow organised storing of the contents.
- Product descriptions of the chemistry set are shown at below list.

catalogue number	pack quantity
067.30.001	1 piece



item photo code	product descriptions	pack quantity
1	filter funnel	1 piece
2	receiver adapter - short stem	1 piece
3	stillhead with screwcap adapter	1 piece
4	receiver adapter - with vent	1 piece
5	pear shape flask with three necks - 25 ml	1 piece
6	erlenmeyer flask - 25 ml	1 piece
7	seperating funnel - with PTFE key - 30 ml	1 piece
8	vigreux fractionating column	1 piece

item photo code	product descriptions	pack quantity
9	measuring cylinder - 10 ml	1 piece
10	beaker - low form - 25 ml	1 piece
11	liebig condenser	1 piece
12	flat bottom flask - 10 ml	1 piece
13	keck clip	1 piece
14	pressure equalising funnel - 10 ml	1 piece
15	hexagonal stoppers	2 pieces
16	microscale chemistry case	1 piece

WATER ESTIMATOR



- Manufactured from borosilicate 3.3 for determination of water with xylol method.
- System consists of a 500 ml flask with NS 29/32 joint, a liebig condenser of 400 mm length and a measuring tube with PTFE stopcock.

catalogue number	pack quantity
065.70.001	1 piece

ARSENIC ESTIMATOR



- Manufactured from borosilicate 3.3 for determination of arsenic and antimony content.
- System consists of a 100 ml erlenmeyer with NS 29/32 joint and an absorption tube attached to erlenmeyer.

catalogue number	pack quantity
065.71.001	1 piece

distillation & filtration & separation & sample preparation



CLIPS - "for NS joints"

- Manufactured from POM with excellent chemical resistance and high mechanical strength.
- With their flexible jaws, they guarantee absolute leak-proof, tight connection of two NS joints.

catalogue number	color	NS size	pack quantity
063.04.010	black	NS 10/19	1 piece
063.04.012	purple	NS 12/21	1 piece
063.04.014	yellow	NS 14/23	1 piece
063.04.019	blue	NS 19/26	1 piece
063.04.024	green	NS 24/29	1 piece
063.04.029	red	NS 29/32	1 piece
063.04.034	orange	NS 34/35	1 piece
063.04.045	brown	NS 45/40	1 piece



JOINT GREASE "standard vacuum"

- Ideal for lubricating and leak-proof sealing of all types of joints, metal and plastic connectors and stopcocks.
- Recommended to be used under standard vacuum conditions.
- Guarantees excellent chemical and temperature resistance between -40°C to +300°C.
- Non-solidifying during use. Easily washable due to water soluble characteristic.
- Best results can be achieved by application of a thin layer.
- Supplied in a tube of 60 gram lubricant weight.

catalogue number	grease color	pack quantity
063.16.001	clear	1 piece



JOINT GREASE "high vacuum"

- Ideal for lubricating and leak-proof sealing of all types of joints, metal and plastic connectors and stopcocks.
- Recommended to be used under high vacuum conditions.
- Guarantees excellent chemical and temperature resistance between -40°C to +320°C.
- Non-solidifying during use. Easily washable due to water soluble characteristic.
- Best results can be achieved by application of a thin layer.
- Supplied in a tube of 60 gram lubricant weight.

catalogue number	grease color	pack quantity
063.16.002	brown	1 piece

JOINT SLEEVES - "PTFE"



- Manufactured from chemically inert PTFE with excellent chemical resistance, high mechanical strength and high temperature resistance between -200°C to +260°C.
- Unique flexible body form guarantees leak-proof connections of NS joints with high vacuum performance.
- Extra smooth interior finish guarantees high vacuum sealing performance without a need of any lubricant.

catalogue number	NS size	pack quantity
063.14.014	NS 14/23	1 piece
063.14.019	NS 19/26	1 piece
063.14.024	NS 24/29	1 piece
063.14.029	NS 29/32	1 piece
063.14.034	NS 34/35	1 piece
063.14.045	NS 45/40	1 piece



SEALING TAPE - "PTFE"

- Manufactured from chemically inert PTFE with excellent chemical resistance, high mechanical strength and high temperature resistance between -200°C to +260°C.
- Stretches, conforms and perfectly seals all joints, connectors, stopcocks with leak-proof tightness.

catalogue number	tape width	tape length	pack quantity
058.06.001	12 mm	10 mt	1 piece

distillation & filtration & separation & sample preparation

CONDENSERS - "liebigh" - "glass side arm"

► Manufactured from heat resistant, durable borosilicate glass according to DIN 12576 standard. Featured with glass side arms fitting 8-9 mm bore size tubings. Thick wall, and reinforced rim prevent breakage during washing and transportation.

catalogue number	effective length	joint NS size	pack quantity
033.11.160	160 mm	NS 14/23	1 piece
033.11.250	250 mm	NS 14/23	1 piece
033.11.252	250 mm	NS 24/29	1 piece
033.11.253	250 mm	NS 29/32	1 piece
033.11.400	400 mm	NS 14/23	1 piece
033.11.402	400 mm	NS 24/29	1 piece
033.11.403	400 mm	NS 29/32	1 piece

CONDENSERS - "liebigh" - "P.P side arm"

► Manufactured from heat resistant, durable borosilicate glass according to DIN 12576 standard. Featured with GL 14 screw thread polypropylene side arms fitting 8-9 mm bore size tubings. Side arms can be easily connected or disconnected to the main body preventing accidental breakage.

catalogue number	effective length	joint NS size	pack quantity
033.12.160	160 mm	NS 14/23	1 piece
033.12.250	250 mm	NS 14/23	1 piece
033.12.252	250 mm	NS 24/29	1 piece
033.12.253	250 mm	NS 29/32	1 piece
033.12.400	400 mm	NS 14/23	1 piece
033.12.402	400 mm	NS 24/29	1 piece
033.12.403	400 mm	NS 29/32	1 piece

CONDENSERS - "allihn" - "glass side arm"

► Manufactured from heat resistant, durable borosilicate glass according to DIN 12581 standard. Featured with glass side arms fitting 8-9 mm bore size tubings. Thick wall and reinforced rim prevent breakage during washing and transportation.

catalogue number	effective length	joint NS size	pack quantity
033.13.160	160 mm	NS 14/23	1 piece
033.13.250	250 mm	NS 14/23	1 piece
033.13.252	250 mm	NS 24/29	1 piece
033.13.253	250 mm	NS 29/32	1 piece
033.13.400	400 mm	NS 14/23	1 piece
033.13.402	400 mm	NS 24/29	1 piece
033.13.403	400 mm	NS 29/32	1 piece

CONDENSERS - "allihn" - "P.P side arm"

► Manufactured from heat resistant, durable borosilicate glass according to DIN 12581 standard. Featured with GL 14 screw thread polypropylene side arms fitting 8-9 mm bore size tubings. Side arms can be easily connected or disconnected to the main body preventing accidental breakage.

catalogue number	effective length	joint NS size	pack quantity
033.14.160	160 mm	NS 14/23	1 piece
033.14.250	250 mm	NS 14/23	1 piece
033.14.252	250 mm	NS 24/29	1 piece
033.14.253	250 mm	NS 29/32	1 piece
033.14.400	400 mm	NS 14/23	1 piece
033.14.402	400 mm	NS 24/29	1 piece
033.14.403	400 mm	NS 29/32	1 piece

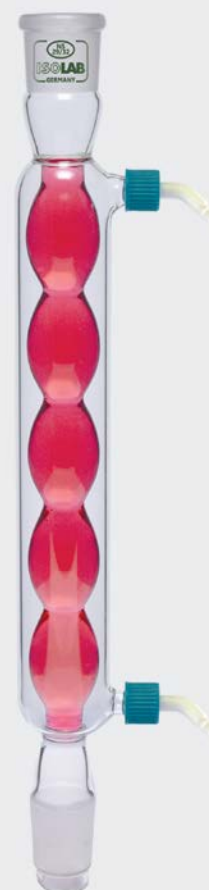
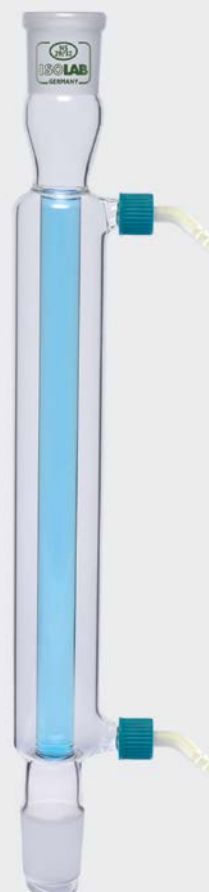
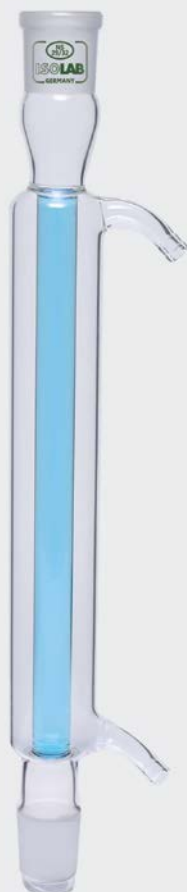

distillation & filtration & separation & sample preparation

CONDENSERS - "spiral" - "glass side arm"

► Manufactured from heat resistant, durable borosilicate glass according to DIN 12592 standard.

► Featured with glass side arms fitting 8-9 mm bore size tubings. Thick wall and reinforced rim prevent breakage during washing and transportation.

catalogue number	effective length	joint NS size	pack quantity
033.15.160	160 mm	NS 14/23	1 piece
033.15.253	250 mm	NS 29/32	1 piece
033.15.403	400 mm	NS 29/32	1 piece

CONDENSERS - "spiral" - "P.P side arm"

► Manufactured from heat resistant, durable borosilicate glass according to DIN 12592 standard.

► Featured with GL 14 screw thread polypropylene side arms fitting 8-9 mm bore size tubings. Side arms can be easily connected or disconnected preventing breakage.

► Thick wall and reinforced rim prevent breakage during washing and transportation.

catalogue number	effective length	joint NS size	pack quantity
033.16.160	160 mm	NS 14/23	1 piece
033.16.253	250 mm	NS 29/32	1 piece
033.16.403	400 mm	NS 29/32	1 piece

CONDENSERS - "dimroth" - "glass side arm"

► Manufactured from heat resistant, durable borosilicate glass according to DIN 12591 standard. Featured with glass side arms fitting 8-9 mm bore size tubings. Thick wall and reinforced rim prevent breakage.

catalogue number	effective length	joint NS size	pack quantity
033.17.160	160 mm	NS 14/23	1 piece
033.17.163	160 mm	NS 29/32	1 piece
033.17.250	250 mm	NS 14/23	1 piece
033.17.253	250 mm	NS 29/32	1 piece
033.17.400	400 mm	NS 14/23	1 piece
033.17.403	400 mm	NS 29/32	1 piece

CONDENSERS - "dimroth" - "P.P side arm"

► Manufactured from heat resistant, durable borosilicate glass according to DIN 12591 standard.

► Featured with GL 14 screw thread polypropylene side arms fitting 8-9 mm bore size tubings. Side arms can be easily connected or disconnected preventing breakage.

catalogue number	effective length	joint NS size	pack quantity
033.18.160	160 mm	NS 14/23	1 piece
033.18.163	160 mm	NS 29/32	1 piece
033.18.250	250 mm	NS 14/23	1 piece
033.18.253	250 mm	NS 29/32	1 piece
033.18.400	400 mm	NS 14/23	1 piece
033.18.403	400 mm	NS 29/32	1 piece

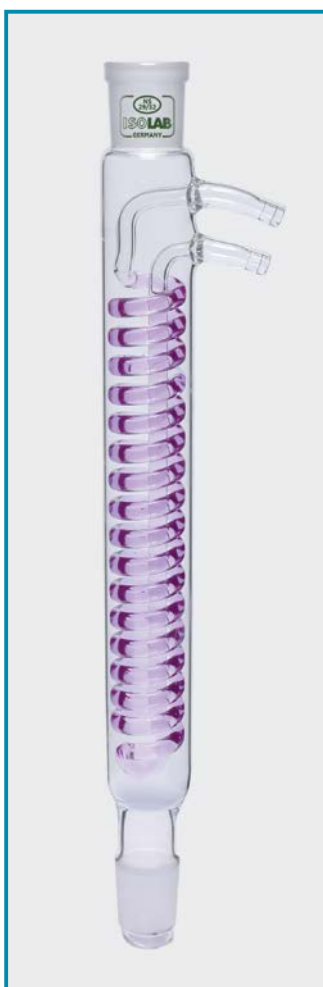
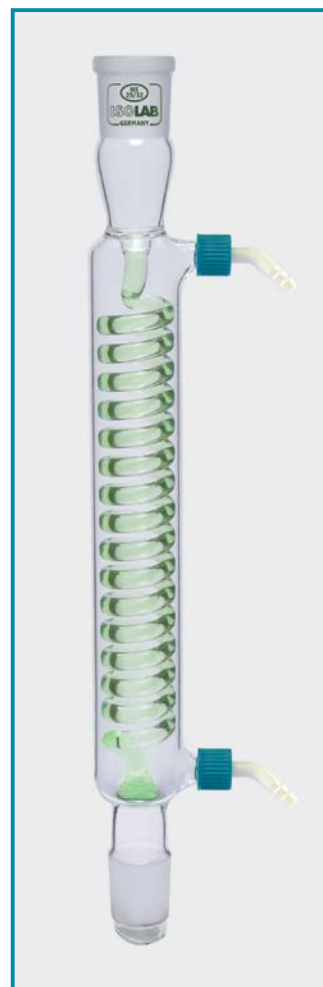
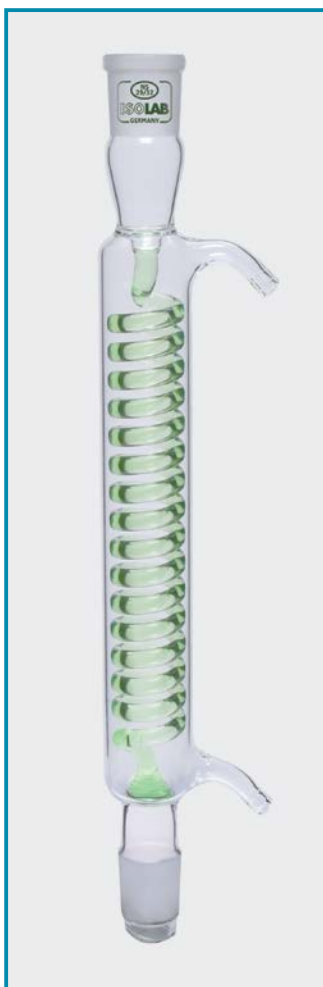

distillation & filtration & separation & sample preparation

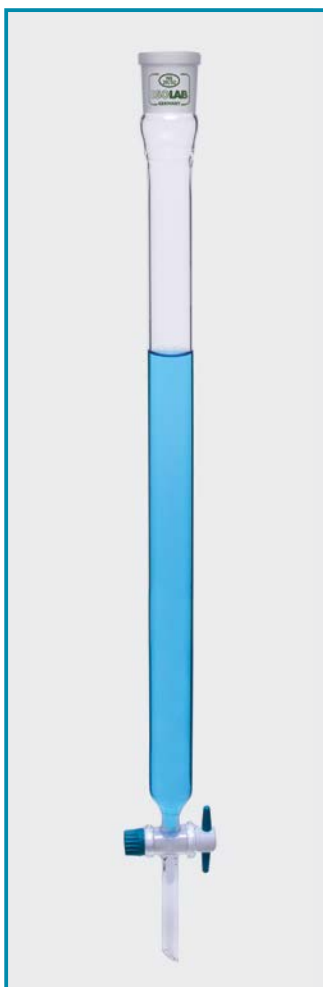

COLUMNS - "chromotography" - "w/o filter"

- Manufactured from borosilicate glass without filter.
- Thick wall and reinforced rim prevent breakage during washing and transportation.
- NS joints are manufactured according to DIN 12242 standard. Supplied with an interchangeable PTFE stopcock which does not require greasing at all.

catalogue number	effective length	internal diameter	socket NS size	pack quantity
066.10.001	200 mm	10 mm	NS 14/23	1 piece
066.10.003	400 mm	20 mm	NS 29/32	1 piece
066.10.004	600 mm	30 mm	NS 29/32	1 piece

COLUMNS - "chromotography" - "with filter"

- Manufactured from borosilicate glass with "pore 1" size sintered glass filter. Reinforced rim prevent breakage.
- Perfectly grinded NS necks with smooth interior are manufactured according to DIN 12242 standard. Supplied with an interchangeable PTFE stopcock which does not require greasing at all.

catalogue number	effective length	internal diameter	socket NS size	pack quantity
066.11.001	200 mm	10 mm	NS 14/23	1 piece
066.11.003	200 mm	15 mm	NS 14/23	1 piece
066.11.002	300 mm	10 mm	NS 14/23	1 piece
066.11.004	400 mm	20 mm	NS 29/32	1 piece
066.11.005	600 mm	30 mm	NS 29/32	1 piece

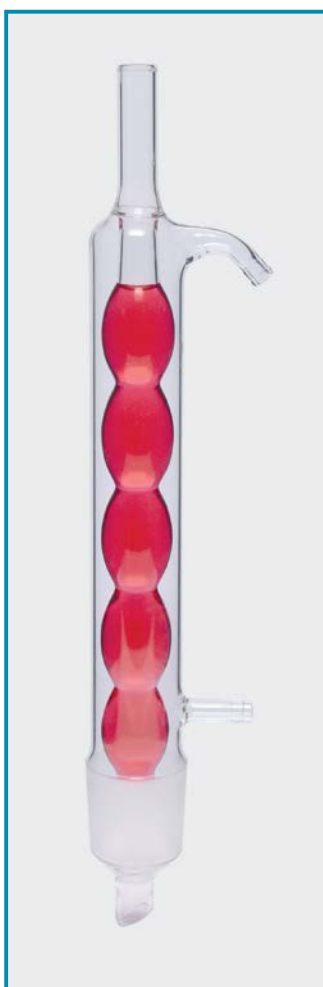
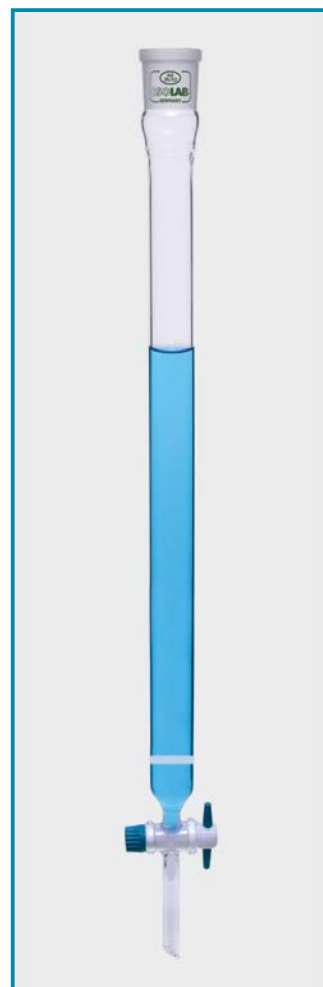

CONDENSERS - "soxhlet" - "allihn" - "glass arm"

- Manufactured from heat resistant, durable borosilicate glass according to DIN 12581 standard.
- Featured with glass side arms fitting 8-9 mm bore size tubings. Thick wall and reinforced rim prevent breakage during washing and transportation.

catalogue number	for extractor volume	cone NS size	pack quantity
035.11.030	30 ml	NS 29/32	1 piece
035.11.070	70 ml	NS 34/35	1 piece
035.11.250	100 / 250 ml	NS 45/40	1 piece
035.11.500	500 ml	NS 45/40	1 piece

CONDENSERS - "soxhlet" - "allihn" - "P.P arm"

- Manufactured from heat resistant, durable borosilicate glass according to DIN 12581 standard. Thick wall, and reinforced rim prevent breakage during washing and transportation.
- Featured with GL 14 screw thread polypropylene side arms fitting 8-9 mm bore size tubings. Side arms can be easily connected or disconnected to the main body preventing accidental breakage.

catalogue number	for extractor volume	cone NS size	pack quantity
035.12.030	30 ml	NS 29/32	1 piece
035.12.070	70 ml	NS 34/35	1 piece
035.12.250	100 / 250 ml	NS 45/40	1 piece
035.12.500	500 ml	NS 45/40	1 piece

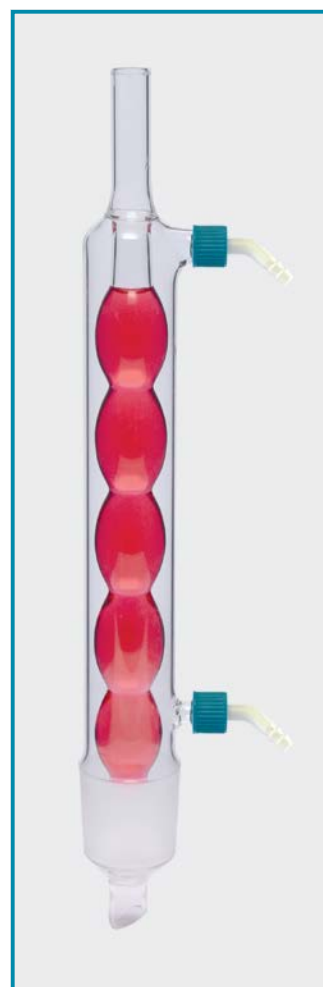

distillation & filtration & separation & sample preparation

CONDENSERS - "soxhlet"- "dimroth"- "glass arm"

► Manufactured from heat resistant, durable borosilicate glass according to DIN 12591 standard.

► Featured with glass side arms fitting 8-9 mm bore size tubings. Thick wall and reinforced rim prevent breakage during washing and transportation.

catalogue number	for extractor volume	cone NS size	pack quantity
035.13.030	30 ml	NS 29/32	1 piece
035.13.070	70 ml	NS 34/35	1 piece
035.13.250	100 / 250 ml	NS 45/40	1 piece
035.13.500	500 ml	NS 45/40	1 piece

CONDENSERS - "soxhlet"- "dimroth"- "P.P arm"

► Manufactured from heat resistant, durable borosilicate glass according to DIN 12591 standard. Thick wall and reinforced rim prevent breakage during washing and transportation.

► Featured with GL 14 screw thread polypropylene side arms fitting 8-9 mm bore size tubings. Side arms can be easily connected or disconnected to the main body preventing accidental breakage.

catalogue number	for extractor volume	cone NS size	pack quantity
035.14.030	30 ml	NS 29/32	1 piece
035.14.070	70 ml	NS 34/35	1 piece
035.14.250	100 / 250 ml	NS 45/40	1 piece
035.14.500	500 ml	NS 45/40	1 piece



EXTRACTORS "soxhlet"

► Manufactured from heat resistant, durable borosilicate glass without stopcock according to DIN 12602 standard.

► Thick wall and reinforced rim prevent breakage during washing and transportation.

► Perfectly grinded NS joint with smooth interior guarantees perfect leakproof sealing.

catalogue number	volume	pack quantity
036.01.030	30 ml	1 piece
036.01.070	70 ml	1 piece
036.01.100	100 ml	1 piece
036.01.150	150 ml	1 piece
036.01.250	250 ml	1 piece
036.01.500	500 ml	1 piece

catalogue number	socket NS size
036.01.030	NS 29/32
036.01.070	NS 34/35
036.01.100	NS 45/40
036.01.150	NS 45/40
036.01.250	NS 45/40
036.01.500	NS 45/40



EXTRACTOR THIMBLES - "cellulose"

► Manufactured from thick and 100 % pure cotton fibres for reproducible results without any harm to the samples.

► Offers high temperature resistance up to 550°C, high mechanical strength and excellent retention capacity.

► Controlled dimensional accuracy guarantees excellent fitting to the extractors body.

► Also suitable for extracting solid or liquid samples from the gases.



catalogue number	diameter	height	pack quantity
102.28.080	28 mm	80 mm	25 pieces
102.30.080	30 mm	80 mm	25 pieces
102.33.080	33 mm	80 mm	25 pieces
102.33.094	33 mm	94 mm	25 pieces
102.34.120	34 mm	120 mm	25 pieces

distillation & filtration & separation & sample preparation

ERLENMEYERS - "glass" - "ground neck"



► Manufactured from heat resistant, durable borosilicate glass according to DIN EN ISO 4797 standard.

► Thick wall, heavy base and reinforced rim prevent breakage during washing and transportation.

► Perfectly grinded NS necks with smooth interior guarantee excellent leak-proof closure.

clear erlenmeyers	amber erlenmeyers	volume	neck NS size	pack quantity
028.01.050		50 ml	NS 14/23	1 piece
028.01.051		50 ml	NS 19/26	1 piece
028.01.052		50 ml	NS 24/29	1 piece
028.01.053	028.11.053	50 ml	NS 29/32	1 piece
028.01.100		100 ml	NS 14/23	1 piece
028.01.101		100 ml	NS 19/26	1 piece
028.01.102		100 ml	NS 24/29	1 piece
028.01.103	028.11.103	100 ml	NS 29/32	1 piece
028.01.250		250 ml	NS 19/26	1 piece
028.01.251		250 ml	NS 24/29	1 piece
028.01.252	028.11.252	250 ml	NS 29/32	1 piece
028.01.300		300 ml	NS 29/32	1 piece
028.01.500		500 ml	NS 19/26	1 piece
028.01.501		500 ml	NS 24/29	1 piece
028.01.502	028.11.502	500 ml	NS 29/32	1 piece
028.01.901	028.11.901	1000 ml	NS 29/32	1 piece
028.01.902	028.11.902	2000 ml	NS 29/32	1 piece

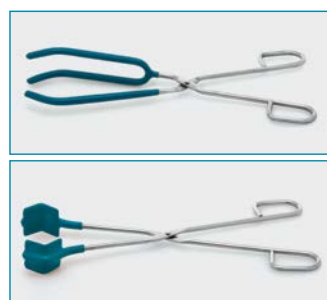

Various flasks tongs can be selected from cat. page no 52.



Various stoppers can be selected from cat. page no 69.

FLASKS - "glass" - "ground neck"



► Manufactured from heat resistant, durable borosilicate glass according to DIN EN ISO 4797 standard.

► Thick wall, heavy base and reinforced rim prevent breakage during washing and transportation.

► Perfectly grinded NS necks with smooth interior guarantee excellent leak-proof closure.



flat bottom clear	round bottom clear	round bottom amber	volume	NS size	pack quantity
030.01.050	030.02.050		50 ml	NS 14/23	1 piece
030.01.051	030.02.051		50 ml	NS 19/26	1 piece
030.01.052	030.02.052		50 ml	NS 24/29	1 piece
030.01.053	030.02.053	030.12.053	50 ml	NS 29/32	1 piece
030.01.100	030.02.100		100 ml	NS 14/23	1 piece
030.01.101	030.02.101		100 ml	NS 19/26	1 piece
030.01.102	030.02.102		100 ml	NS 24/29	1 piece
030.01.103	030.02.103	030.12.103	100 ml	NS 29/32	1 piece
030.01.250	030.02.250		250 ml	NS 19/26	1 piece
030.01.251	030.02.251		250 ml	NS 24/29	1 piece
030.01.252	030.02.252	030.12.252	250 ml	NS 29/32	1 piece
030.01.500	030.02.500		500 ml	NS 24/29	1 piece
030.01.501	030.02.501	030.12.501	500 ml	NS 29/32	1 piece
030.01.900	030.02.900		1000 ml	NS 24/29	1 piece
030.01.901	030.02.901	030.12.901	1000 ml	NS 29/32	1 piece
030.01.902	030.02.902		2000 ml	NS 29/32	1 piece
030.01.904	030.02.904		4000 ml	NS 29/32	1 piece

distillation & filtration & separation & sample preparation



FLASKS - "2 ground neck"
"20° angled & parallel side neck"

➤ Manufactured from heat resistant, durable borosilicate glass according to DIN 12392 & DIN12394 standards.

➤ Thick wall, heavy base and reinforced rim prevent breakage during washing and transportation.

➤ Perfectly grinded NS necks with smooth interior guarantee excellent leak-proof closure.

flasks angled side neck	flasks parallel side neck	volume	center NS size	side NS size
030.24.050	030.30.050	50 ml	14/23	14/23
030.24.100	030.30.100	100 ml	14/23	14/23
030.24.250	030.30.250	250 ml	14/23	14/23
030.25.100	030.31.100	100 ml	24/29	14/23
030.25.250	030.31.250	250 ml	24/29	14/23
030.25.500	030.31.500	500 ml	24/29	14/23
030.25.901	030.31.901	1000 ml	24/29	14/23
030.26.100	030.32.100	100 ml	24/29	19/26
030.26.250	030.32.250	250 ml	24/29	19/26
030.26.500	030.32.500	500 ml	24/29	19/26
030.26.901	030.32.901	1000 ml	24/29	19/26
030.27.100	030.33.100	100 ml	29/32	14/23
030.27.250	030.33.250	250 ml	29/32	14/23
030.27.500	030.33.500	500 ml	29/32	14/23
030.27.901	030.33.901	1000 ml	29/32	14/23
030.27.902	030.33.902	2000 ml	29/32	14/23
030.28.100	030.34.100	100 ml	29/32	19/26
030.28.250	030.34.250	250 ml	29/32	19/26
030.28.500	030.34.500	500 ml	29/32	19/26
030.28.901	030.34.901	1000 ml	29/32	19/26
030.28.902	030.34.902	2000 ml	29/32	19/26
030.29.100	030.35.100	100 ml	29/32	29/32
030.29.250	030.35.250	250 ml	29/32	29/32
030.29.500	030.35.500	500 ml	29/32	29/32
030.29.901	030.35.901	1000 ml	29/32	29/32
030.29.902	030.35.902	2000 ml	29/32	29/32



FLASKS - "3 ground neck"
"20° angled & parallel side neck"

➤ Manufactured from heat resistant, durable borosilicate glass according to DIN 12392 & DIN12394 standards.

➤ Thick wall, heavy base and reinforced rim prevent breakage during washing and transportation.

➤ Perfectly grinded NS necks with smooth interior guarantee excellent leak-proof closure.

flasks angled side neck	catalogue number	volume	center NS size	side NS size
030.36.250	030.42.250	250 ml	14/23	14/23
030.37.250	030.43.250	250 ml	24/29	14/23
030.37.500	030.43.500	500 ml	24/29	14/23
030.37.901	030.43.901	1000 ml	24/29	14/23
030.38.250	030.44.250	250 ml	24/29	19/26
030.38.500	030.44.500	500 ml	24/29	19/26
030.38.901	030.44.901	1000 ml	24/29	19/26
030.38.902	030.44.902	2000 ml	24/29	19/26
030.39.250	030.45.250	250 ml	29/32	14/23
030.39.500	030.45.500	500 ml	29/32	14/23
030.39.901	030.45.901	1000 ml	29/32	14/23
030.40.250	030.46.250	250 ml	29/32	19/26
030.40.500	030.46.500	500 ml	29/32	19/26
030.40.901	030.46.901	1000 ml	29/32	19/26
030.41.250	030.47.250	250 ml	29/32	29/32
030.41.500	030.47.500	500 ml	29/32	29/32
030.41.901	030.47.901	1000 ml	29/32	29/32
030.41.902	030.47.902	2000 ml	29/32	29/32



distillation & filtration & separation & sample preparation

FLASKS - "clear" - "glass" - "pear shape"



➤ Manufactured from heat resistant, durable borosilicate glass according to DIN 12383 standard.

➤ Thick wall, heavy base and reinforced rim prevent breakage during washing and transportation.

➤ Perfectly grinded NS necks with smooth interior guarantee excellent leak-proof closure.

catalogue number	volume	NS size	pack qty.
030.49.010	10 ml	NS 14/23	1 pc
030.49.025	25 ml	NS 14/23	1 pc
030.49.050	50 ml	NS 14/23	1 pc
030.49.100	100 ml	NS 14/23	1 pc
030.49.250	250 ml	NS 14/23	1 pc
030.52.050	50 ml	NS 29/32	1 pc
030.52.100	100 ml	NS 29/32	1 pc
030.52.250	250 ml	NS 29/32	1 pc

FLASKS - "glass" - "evaporating"



➤ Manufactured from heat resistant, durable borosilicate glass.

➤ Thick wall, heavy base and reinforced rim prevent breakage during washing and transportation.

➤ Perfectly grinded NS necks with smooth interior guarantee excellent leak-proof closure.

➤ Volume graduations and inscriptions are printed with white enamel.

catalogue number	volume	evaporating NS size	pack quantity
030.55.100	100 ml	NS 29/32	1 piece
030.55.250	250 ml	NS 29/32	1 piece
030.55.500	500 ml	NS 29/32	1 piece
030.55.901	1000 ml	NS 29/32	1 piece

FLASKS - "clear" - "glass" - "kjeldahl"



➤ Manufactured from heat resistant, durable borosilicate glass according to DIN 12360 standard.

➤ Thick wall, heavy base and reinforced rim prevent breakage during washing and transportation.

➤ Perfectly grinded NS necks with smooth interior guarantee excellent leak-proof closure.

catalogue number	volume	NS size	pack qty.
030.57.100	100ml	NS 19/26	1 pc
030.57.250	250ml	NS 29/32	1 pc
030.57.500	500ml	NS 29/32	1 pc
030.57.750	750ml	NS 29/32	1 pc
030.57.901	1000ml	NS 29/32	1 pc

FLASKS - "receiving"

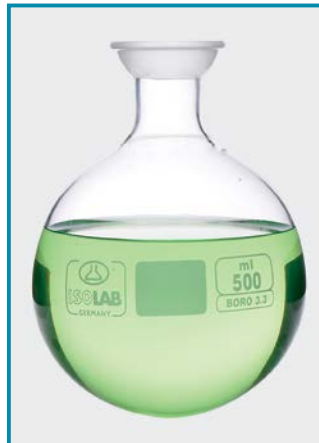

➤ Manufactured from heat resistant, durable borosilicate glass.

➤ Thick wall, heavy base and reinforced rim prevent breakage during washing and transportation.

➤ Perfectly grinded NS necks with smooth interior guarantee excellent leak-proof closure.

catalogue number	volume	receiving NS size	pack quantity
030.56.100	100 ml	KS 35	1 piece
030.56.250	250 ml	KS 35	1 piece
030.56.500	500 ml	KS 35	1 piece
030.56.901	1000 ml	KS 35	1 piece

CLIPS - "for receiving flasks"

➤ Manufactured from stainless steel with excellent chemical resistance and superior mechanical strength.

➤ Perfect tools to keep two KS joints fastened firmly to each other.

catalogue number	pack quantity
063.05.001	1 piece



distillation & filtration & separation & sample preparation

FLASKS - "clear" - "glass" - "nitrogen"



► Manufactured from heat resistant, durable borosilicate glass according to DIN and ISO standards. Featured with an 25° angle PTFE stopcock.

► Thick wall, heavy base and reinforced rim prevent breakage during washing and transportation.

► Perfectly grinded NS necks with smooth interior guarantee excellent leak-proof closure.

catalogue number	volume	neck NS size	pack quantity
030.58.025	25 ml	NS 14/23	1 piece
030.58.050	50 ml	NS 14/23	1 piece
030.58.100	100 ml	NS 14/23	1 piece
030.58.250	250 ml	NS 14/23	1 piece
030.59.050	50 ml	NS 29/32	1 piece
030.59.100	100 ml	NS 29/32	1 piece
030.59.250	250 ml	NS 29/32	1 piece
030.59.500	500 ml	NS 29/32	1 piece
030.59.901	1000 ml	NS 29/32	1 piece



CLIPS - "for NS joints"

► Manufactured from POM with excellent chemical resistance and high mechanical strength.

► With their flexible jaws, they guarantee absolute leak-proof, tight connection of two NS joints.

catalogue number	color	NS size	pack quantity
063.04.010	black	NS 10/19	1 piece
063.04.012	purple	NS 12/21	1 piece
063.04.014	yellow	NS 14/23	1 piece
063.04.019	blue	NS 19/26	1 piece
063.04.024	green	NS 24/29	1 piece
063.04.029	red	NS 29/32	1 piece
063.04.034	orange	NS 34/35	1 piece
063.04.045	brown	NS 45/40	1 piece

FLASK STANDS - "P.P"

► Manufactured from best quality heat resistant, polypropylene for holding round bottom flasks.

► Unique wall design offers an excellent support at every point of contact.

► Easily stackable due to the tapered body form for reducing storage space.

catalogue number	for flasks volume	pack quantity
029.14.902	100 - 2000 ml	1 piece



FLASK STANDS - "cork"

► Manufactured from best quality heat resistant, non-porous, natural cork for holding round bottom flasks.

► Unique wall design offers an excellent support at every point of contact.

catalogue number	recommended flask volume	pack quantity
029.04.001	50 - 100 ml	1 piece
029.04.002	250 - 500 ml	1 piece
029.04.003	1000 - 2000 ml	1 piece
029.04.004	3000 ml	1 piece
029.04.005	4000 ml	1 piece



distillation & filtration & separation & sample preparation



WATER STILLS - "basic"

- Offers space saving, and practical design with economical energy and water consumption. Supplies laboratory grade, distilled water free off pyrogen.
- Double walled interior chamber is manufactured from cavitation-proof, seamless, corrosion resistant stainless steel.
- Interior chamber should always be kept clean for consistent supply of pure water. Easily removable condenser unit enables fast and efficient cleaning of the chamber.
- Integrated low water protection system turns off heating in case lack of water. Integrated over temperature protection system turns off heating in case of a sudden increase of heat.
- Automatic circuit breakers ensure user safety in case of over temperature and over current problems.

catalogue no	623.01.004	623.01.008
dimensions (mm)	380 x 290 x 580	380 x 365 x 640
voltage (V)	220	220
frequency (Hz)	50 / 60	50 / 60
heating power (W)	3000	6000
output capacity (L/hr)	3,5	7,5
cooling water usage (L/hr)	30 - 50	60 - 80
controler	hydraulic thermostat	
safety devices	over temperature breaker water level switch	
water conductivity	~ 2,3 μ S	



WATER STILLS - "automatic"

- Offers many advantages with fully automatic operation, space saving unique design economical energy and water consumption. Supplies laboratory grade, distilled water free off pyrogen.
- Built-in large storage tank stores the produced water. Double walled interior chamber is manufactured from cavitation-proof, corrosion resistant stainless steel.
- Interior chamber should always be kept clean for consistent pure water quality. Easily removable condenser unit enables fast and efficient cleaning of the chamber.
- Pre-filter system prevents undesired impurities to enter.
- Integrated low water protection system turns off heating in case of low water inlet or lack of water supplied.
- Integrated over temperature protection system turns off heating in case of a sudden increase of heat.

catalogue no	623.02.004	623.02.008
dimensions (mm)	740 x 345 x 515	680 x 360 x 650
voltage (V)	220	220
frequency (Hz)	50 / 60	50 / 60
heating power (W)	3000	6000
output capacity (L/hr)	4	8
storage capacity (L)	8	14
cooling water usage (L/hr)	30 - 50	60 - 80v
controler	hydraulic thermostat	
safety devices	temperature breaker, water level switch water float level sensor	
water conductivity	~ 2,3 μ S	

PRE - FILTER

- Pre-filter system prevents undesired impurities and built-in large storage tank stores the produced water.
- Filter part in the pre-filter system should be controlled often and should be immediately replaced in case of dirt.

catalogue number	pack quantity
623.11.110	1 piece



distillation & filtration & separation & sample preparation

ROTARY EVAPORATORS - "vertical"

- Featured with motorised quick-action lift that automatically raises the evaporation flask from the bath in case of any power failure.
- Chemical-resistant double PTFE system and patented pressure spring guarantees an excellent sealing during operation.
- Easy to read large digital LCD screen displays heating temperature, rotation speed, time and other parameters.
- Patented condenser design with 1.500 cm² effective cooling capacity guarantees excellent cooling effect.
- Unique motor action enabling selective rotation of the evaporation flask as clockwise or anti-clockwise movement guarantees effective results.
- Featured with an adjustable final position recognition system for protection of the glass parts from breakage.
- Timer function with time setting range 1 - 999 minute enables precise control of the operation.
- Supplied with a large, stainless steel 5 L water-oil bath with precise temperature control from ambient to 180°C.
- An automatic over-heat protection system automatically stops heating if the bath temperature exceeds 220°C.



Integrated operating panel for convenient control of the main unit and also the heating bath.

Unique design of the detachable operating panel enables remote control option and easy use of the panel outside the fume hood.



Featured with an adjustable final position recognition system for protection of the glass parts from breakage. Unique push-off device to release the flask and protect it from breaking.

Chemical-resistant double PTFE system and patented pressure spring guarantees an excellent sealing during operation.

Optimal interval operation offers dual action in clockwise and counter clockwise for the drying process.

catalogue no (Vertical)	605.01.001
dimensions / weight (mm / kg)	465 x 457 x 583 / 15,0
power (W)	1400
voltage (V)	220
frequency (Hz)	50 / 60
heating range (°C)	ambient +5 to 180
heating accuracy (°C)	± 1,0
speed range (rpm)	20 - 280
speed & temp. & time display	LCD
time setting range (min)	1 - 999
rotation direction	reversible
protection class	IP 20
USB interface	yes

spare parts for rotary evaporator

catalogue number	product descriptions	pack quantity
605.01.101	vertical condenser	1 piece
605.01.115	diagonal condenser	1 piece
605.01.102	evaporating flask 50 ml	1 piece
605.01.103	evaporating flask 100 ml	1 piece
605.01.104	evaporating flask 250 ml	1 piece
605.01.105	evaporating flask 500 ml	1 piece
605.01.106	evaporating flask 1000 ml	1 piece
605.01.107	evaporating flask 2000 ml	1 piece
605.01.108	receiving flask 100 ml	1 piece
605.01.109	receiving flask 250 ml	1 piece
605.01.110	receiving flask 500 ml	1 piece
605.01.111	receiving flask 1000 ml	1 piece
605.01.112	foam brake	1 piece
605.01.113	vapor tube	1 piece
605.01.114	connection seal	1 piece

distillation & filtration & separation & sample preparation



FUNNELS
"glass" - "plain"

➤ Manufactured from heat resistant, durable borosilicate glass with short stem according to ISO 4798 standard.

➤ 60° cone filtering angle guarantees excellent adaptation of the filter papers.

catalogue number	funnel diameter	pack quantity
041.01.040	40 mm	10 pieces
041.01.060	60 mm	10 pieces
041.01.080	80 mm	10 pieces
041.01.100	100 mm	10 pieces
041.01.120	120 mm	6 pieces
041.01.150	150 mm	6 pieces



FUNNELS
"PP" - "plain"

➤ Manufactured from translucent polypropylene with short stem according to ISO 4798 standard.

➤ 60° cone filtering angle guarantees excellent adaptation of the filter papers.

catalogue number	funnel diameter	pack quantity
041.02.040	40 mm	1 piece
041.02.060	60 mm	1 piece
041.02.080	80 mm	1 piece
041.02.100	100 mm	1 piece
041.02.120	120 mm	1 piece
041.02.150	150 mm	1 piece



FUNNELS
"glass" - "analytical"

➤ Manufactured from borosilicate glass with long stem according to ISO 4798 standard.

➤ 60° cone filtering angle guarantees excellent adaptation of the filter papers.

➤ Internal helicoid ribs increase the filtering speed also prevent back pressure and airlocks.

glass funnel	funnel diameter	pack quantity
041.03.080	80 mm	1 piece



FUNNELS
"PP" - "analytical"

➤ Manufactured from translucent polypropylene with short stem according to ISO 4798 standard.

➤ 60° cone filtering angle guarantees excellent adaptation of the filter papers.

➤ Internal helicoid ribs increase the filtering speed also prevent back pressure and airlocks.

PP funnel	funnel diameter	pack quantity
041.04.080	80 mm	1 piece



FUNNELS - "powder" - "PP & glass"

➤ Manufactured from polypropylene or from borosilicate glass specially for transferring powders.

➤ Stem guarantees perfect fit to the flask necks and large bore diameter guarantees fast delivery of the material.

funnel diameter	PP funnels	glass funnels	cone NS size	pack quantity
65 mm	041.07.065	041.08.060	14/23	1 piece
80 mm	041.07.080	041.08.080	19/26	1 piece
100 mm	041.07.100	041.08.100	24/29	1 piece
120 mm	041.07.120	041.08.120	29/32	1 piece
150 mm	041.07.150			1 piece



FUNNELS - "polypropylene" - "ribbed"



➤ Manufactured from translucent polypropylene with short stem according to ISO 4798 standard.

➤ Helicoid ribs increase the filtering speed also prevent back pressure and airlocks.

➤ 60° cone angle for perfect adaptation of the filter papers.

catalogue number	funnel diameter	pack quantity
041.05.040	40 mm	1 piece
041.05.060	60 mm	1 piece
041.05.080	80 mm	1 piece
041.05.100	100 mm	1 piece
041.05.120	120 mm	1 piece
041.05.150	150 mm	1 piece

distillation & filtration & separation & sample preparation



FUNNELS HOLDERS
"steel" - "without bosshead"

➤ Manufactured from high quality, corrosion resistant chromated steel for holding all kinds of funnels up to 150 mm diameter in the most secure way.

➤ Unique ring shape with a slit offers practical use also with separating funnels.

catalogue number	holder diameter	pack quantity
042.03.040	40 mm	1 piece
042.03.060	60 mm	1 piece
042.03.080	80 mm	1 piece
042.03.100	100 mm	1 piece



FUNNELS HOLDERS
"steel" - "with bosshead"

➤ Manufactured from high quality, corrosion resistant chromated steel for holding all kinds of funnels up to 150 mm diameter in the most secure way.

➤ Ring with slit offers use also with separating funnels.

➤ The boss head mounted to the stem enables fast and easy attachment of the funnel holder to the stand rods.

catalogue number	holder diameter	pack quantity
042.04.040	40 mm	1 piece
042.04.060	60 mm	1 piece
042.04.080	80 mm	1 piece
042.04.100	100 mm	1 piece



FUNNELS HOLDER
"polypropylene" - "without slit"

➤ Manufactured from polypropylene for holding all kinds of funnels from 60 mm up to 150 mm diameter in the most secure way.

➤ Two tapered wedges in the locking system are used to ensure firm grip on rods of diameter range 10 mm to 13 mm.



Funnel holder without slit consists of 2 parts.

catalogue number	pack quantity
042.05.001	1 piece



FUNNELS HOLDER
"polypropylene" - "with slit"

➤ Manufactured from polypropylene for holding all kinds of funnels from 60 mm up to 150 mm diameter in the most secure way.

➤ Specially recommended to be used with separating funnels.

➤ Two tapered wedges in the locking system are used to ensure firm grip on rods of diameter range 10 mm to 13 mm.



Funnel holder with slit consists of 1 part.

catalogue number	pack quantity
042.06.001	1 piece



FUNNELS HOLDER
"steel" - "adjustable height"

➤ Manufactured from high quality, corrosion resistant chromated steel for holding all kinds of funnels up to 150 mm diameter in the most secure way.

➤ The extendable funnel ring guarantees practical use with different funnel heights.

catalogue number	pack quantity
042.06.010	1 piece

distillation & filtration & separation & sample preparation



FLASKS - "filter"
"glass" - "glass side arm"

- Manufactured from borosilicate glass according to ISO 6556 standard.
- Featured with glass side arm fitting 6-10 mm bore size tubings.
- Thick wall, heavy base and reinforced rim prevent breakage during washing and transportation.

catalogue number	volume	pack quantity
040.01.100	100 ml	1 piece
040.01.250	250 ml	1 piece
040.01.500	500 ml	1 piece
040.01.901	1000 ml	1 piece
040.01.902	2000 ml	1 piece



FLASKS - "filter"
"glass" - "P.P side arm"

- Manufactured from borosilicate glass according to ISO 6556 standard.
- Featured with GL 14 screw thread P.P side arm fitting 6-10 mm bore size tubings. Side arms can be easily connected or disconnected to the body preventing accidental breakage.

catalogue number	volume	pack quantity
040.02.100	100 ml	1 piece
040.02.250	250 ml	1 piece
040.02.500	500 ml	1 piece
040.02.901	1000 ml	1 piece
040.02.902	2000 ml	1 piece



PROTECTIVE COLLARS
"for filter flasks"

- Manufactured from natural rubber with a special design that keeps the funnel and filtering flask always in center.
- These adapters also provide all-round protection reducing impact damages.
- Also clean seal is created between the flask rim and the funnel neck.

catalogue number	for flask volume	pack quantity
040.05.001	100 ml	1 piece
040.05.002	250 - 500 ml	1 piece
040.05.003	1000 ml	1 piece
040.05.004	2000 ml	1 piece



FUNNELS - "büchner"
"porcelain" - "P.P"

- Porcelain büchner funnels are manufactured from thick and robust glazed porcelain according to DIN 12905 to be used with filter funnels. Support plate with holes holds the filter paper allows maximum filtering speed.
- Polypropylene büchner funnels are manufactured from polypropylene with a perforated filter plate. The upper part can be stacked with the lower part to form a vacuum seal. Upper and lower parts can be separated for efficient cleaning.

funnels porcelain	funnels P.P	inner diameter	pack quantity
042.01.070	042.02.070	75 mm	1 piece
042.01.090	042.02.090	90 mm	1 piece
042.01.110	042.02.110	110 mm	1 piece



distillation & filtration & separation & sample preparation

FUNNELS - "gooch" - "glass" "with sintered glass disc"



➤ Manufactured from heat resistant, durable borosilicate glass with an acid resistant sintered glass disc for filtration.

➤ Guarantees an easy and fast filtering without the need of any kind of filter paper.

➤ Heavy and thick body construction and reinforced rim prevent breakage during washing and transportation.

catalogue number	nominal volume	porosity grade	type	pack quantity
043.01.051	50 ml	1	3 D	1 piece
043.01.052	50 ml	2	3 D	1 piece
043.01.053	50 ml	3	3 D	1 piece
043.01.054	50 ml	4	3 D	1 piece
043.01.071	75 ml	1	11 D	1 piece
043.01.072	75 ml	2	11 D	1 piece
043.01.073	75 ml	3	11 D	1 piece
043.01.074	75 ml	4	11 D	1 piece
043.01.121	125 ml	1	17 D	1 piece
043.01.122	125 ml	2	17 D	1 piece
043.01.123	125 ml	3	17 D	1 piece
043.01.124	125 ml	4	17 D	1 piece
043.01.501	500 ml	1	25 D	1 piece
043.01.502	500 ml	2	25 D	1 piece
043.01.503	500 ml	3	25 D	1 piece
043.01.504	500 ml	4	25 D	1 piece



CRUCIBLES - "gooch" - "glass" - "with sintered glass disc"



➤ Manufactured from heat resistant, durable borosilicate glass with an acid resistant sintered glass disc for filtration.

➤ Guarantees an easy and fast filtering without the need of any kind of filter paper.

➤ Heavy and thick body construction and reinforced rim prevent breakage during washing and transportation.

crucibles sint. glass	porosity grade	nominal volume	diameter	pack quantity
043.02.031	1	30 ml	30 mm	1 piece
043.02.032	2	30 ml	30 mm	1 piece
043.02.033	3	30 ml	30 mm	1 piece
043.02.034	4	30 ml	30 mm	1 piece
043.02.051	1	50 ml	40 mm	1 piece
043.02.052	2	50 ml	40 mm	1 piece
043.02.053	3	50 ml	40 mm	1 piece
043.02.054	4	50 ml	40 mm	1 piece



GASKETS - "natural rubber"

➤ Manufactured from natural rubber with conical body form. Designed to fit Buchner funnels and Gooch funnels.

➤ Can be used also reverse cleaning of filter crucibles and as a support to standard funnels.

➤ Conical body form guarantees perfect fitting of funnels, filter funnels and crucibles to the filter flask necks.

➤ Supplied as a set of 7 different size adapters which guarantee perfect fit to all filter funnel necks with different volume sizes.



catalogue number
040.06.001

pack quantity
1 set

CRUCIBLES - "gooch" - "porcelain" - "with perforated base"

➤ Manufactured from glazed porcelain with perforated bottom layer.

➤ The crucible body form guarantees perfect fit to "GUKO" adapters.

crucibles sint. glass	nominal volume	diameter x height	pack quantity
043.08.015	15 ml	29 x 33 mm	6 pieces
043.08.030	25 ml	36 x 45 mm	6 pieces
043.08.050	40 ml	40 x 50 mm	6 pieces

distillation & filtration & separation & sample preparation

VACUUM MANIFOLDS - "stainless steel"



Volume graduation inside walls of the funnels offer practical volume indication of the sample.



Closure clamps under each funnels once closed guarantee perfect and vacuum tight sealing.



The stainless steel frit filter supports 47/50 mm diameter ensures a uniform distribution.

➤ Vacuum manifolds allow filtration of multiple samples either at once or independently by controlling the separate branch valves. Suitable to be used with 47/50 mm diameter membrane filters.

➤ Body and the funnels are manufactured from AISI 304 quality stainless steel to be used at food, beverage, pharmaceutical and water quality laboratories.

➤ The main body is featured with handles on both sides for easy hold and carriage.

➤ Stainless steel funnels has a volume capacity of 500 ml. They can be used for sample volumes from 50 ml up to 500 ml.

➤ Volume graduation inside walls of the funnels offer practical volume indication of the sample.

➤ Attachment and removal of the funnels can be easily achieved with the attached closure clamp.

➤ Closure clamps under each funnel once closed guarantee perfect and vacuum tight sealing.

➤ The stainless steel frit filter support ensures a uniform distribution of the residues.

➤ All parts of vacuum filter set are fully autoclavable. They can also flame sterilized.

➤ Vacuum manifolds are supplied with a cap for each funnel.

catalogue number	manifold model	pack quantity
043.05.101	1 station	1 piece
043.05.103	3 stations	1 piece
043.05.106	6 stations	1 piece

FILTER FLASK "for vacuum system"

➤ Manufactured from borosilicate glass according to ISO 6556 standard with a volume of 2000 ml. Featured with GL 14 screw thread polypropylene side arms fitting 6-10 mm bore size tubings.

➤ Side arms can be easily connected or disconnected for easy use.

FILTER BOTTLE "for vacuum system"

➤ Manufactured from borosilicate glass according to ISO 6556 standard with a volume of 5000 ml. Featured with GL 14 screw thread polypropylene side arms fitting 6-10 mm bore size tubings.

➤ Side arms can be easily connected or disconnected for easy use.

filter flask	filter bottle	pack quantity
043.06.001	043.06.011	1 piece





VACUUM FILTER SET

➤ Manufactured from borosilicate glass particularly suitable for analysis of microscopic residues, particle controls and multipurpose filtration application.

➤ Thick wall, heavy base and reinforced rim prevent breakage during washing and transportation.

➤ Suitable to be used with 47/50 mm diameter membrane filters.

➤ Supplied with filter funnel of 300 ml volume capacity, support base with sintered disc, vacuum connection side arm, connecting clamp and 1000 ml flask.

catalogue number	vacuum flask	pack quantity
043.03.001	1000 ml	1 piece



VACUUM FLASK

➤ Manufactured from borosilicate glass with thick walls resistant to vacuum applications with NS 29/32 reverse joint.

catalogue number	flask volume	pack quantity
043.03.005	1000 ml	1 piece
043.03.007	2000 ml	1 piece



CLAMP

➤ Manufactured from aluminium for tight closure of the support base with sinter plate to the filter funnel.

catalogue number	pack quantity
043.03.002	1 piece



FILTER FUNNEL

➤ Manufactured from borosilicate glass for excellent fit to the top of the support part.

catalogue number	funnel volume	pack quantity
043.03.003	300 ml	1 piece
043.03.006	500 ml	1 piece



SUPPORT BASE

➤ Manufactured from borosilicate glass with excellent fit to the bottom of the filter funnel with a glass filter disc plate.

catalogue number	pack quantity
043.03.004	1 piece

distillation & filtration & separation & sample preparation



FILTER PAPERS - "quantitative"

- Quantitative papers are recommended for analytical and gravimetric analysis.
- Manufactured first from high quality 100% cotton fibres. They are further treated with dilute acid to remove any remaining organic or inorganic impurities. As the last step they are washed and cleaned with demineralised water.
- They guarantee low ash content around less than 0,01% and around 95% alpha-cellulose amount.

M. Nagel cat. no	ISOLAB cat. no	color code	filtration speed	diameter	pack quantity
105.01.110	105.11.110	blue	slow	110 mm	100 pieces
105.02.110	105.12.110	white	medium	110 mm	100 pieces
105.03.110	105.13.110	black	fast	110 mm	100 pieces
105.01.125	105.11.125	blue	slow	125 mm	100 pieces
105.02.125	105.12.125	white	medium	125 mm	100 pieces
105.03.125	105.13.125	black	fast	125 mm	100 pieces



FILTER PAPERS - "qualitative"

- Qualitative papers are recommended for routine separation work.
- They are manufactured from high quality 100% cellulose fibres for consistent filtration speed, loading capacity and wet strength.
- They guarantee low ash content around less than 0,1% and around 59% alpha-cellulose amount.

M. Nagel cat. no	ISOLAB cat. no	grade	filtration speed	diameter	pack quantity
106.01.110	106.11.110	No:2	slow medium	110 mm	100 pieces
106.02.110	106.12.110	No:1	medium	110 mm	100 pieces
106.03.110	106.13.110	No:4	fast	110 mm	100 pieces
106.01.125	106.11.125	No:2	slow medium	125 mm	100 pieces
106.02.125	106.12.125	No:1	medium	125 mm	100 pieces
106.03.125	106.13.125	No:4	fast	125 mm	100 pieces



FILTER PAPERS - "general purpose"

- Manufactured from high quality 100% cellulose with a good humidity resistance and relatively high absorption capacity.
- Suitable for general laboratory filtrations. Alternatively, can also be used as a bench protector or pharmaceutical product preparation.

catalogue number	paper dimensions	paper specifications	pack quantity
107.40.140	40 x 40 cm	60 gr / m ²	250 pieces
107.58.158	58 x 58 cm	60 gr / m ²	250 pieces



FORCEPS - "for filter papers"

- Manufactured from high quality, chemical and corrosion resistant AISI 304 grade stainless steel.
- Most commonly used forceps for placing and picking filter papers during filtering process.
- Robust and seamless construction guarantees long life cycle.
- Grid lines on the middle part enable safe and easy handling.

catalogue number	total length	pack quantity
048.04.001	120 mm	1 piece

distillation & filtration & separation & sample preparation

PUMPS - "vacuum & pressure"



➤ Ideal pumps for all kinds of filtration applications and also for air sampling, suspended solid tests, vacuum distillation, gel drying, chromatography applications. Can be used simultaneously both as a vacuum pump and as a pressure pump for pressure supply.

➤ Piston driven, belt free motor does not need any oil or lubricant and offers continuous oil free pumping. Siliconised rubber feet holds the pumps on the bench surface.

➤ Unique design of the pump guarantees maintenance free and long life cycle with minimum noise level less than 50dB.

➤ Filter barrier in the air exchange compartment of the pump enables clean air cycling at all times. Vacuum and pressure indicator at model 622.12.001 shows operational vacuum and pressure values at all times.

➤ Thermal protection system for overheating guarantees automatic stop in case of over heat during process.

catalogue number	maximum flow rate	maximum vacuum	maximum pressure	tube thread	motor power	total weight	vacuum & pressure indicator	dimensions
622.11.001	15 L/min.	250 mbar	30 Psi	6 mm	75 watt	4 kg	non	195x98x156 mm
622.12.001	30 L/min.	200 mbar	30 Psi	6 mm	160 watt	8 kg	yes	210x160x235 mm



WATER JET PUMP "polypropylene"

➤ Manufactured from polypropylene for continuous filtering applications.

➤ Suitable to operate under 10 kg/cm² water pressure.

➤ Featured with a non-return valve that eliminates water back flow.

➤ Easily dismantled for effective cleaning.

➤ Can be used also as a simple vacuum pump.

catalogue number	pack quantity
040.10.001	1 piece



FLOW INDICATOR

➤ Manufactured from PMP for precise optical indication of the flow. Can resist max 2 bar pressure. Can be used with tubings of 6 to 11 mm internal diameter.

➤ For optimum performance the minimum flow rate of 50 ml/minute (vertically) and 140 ml / minute (horizontally) is required.

➤ Functions in both directions and can be mounted with any angle.

catalogue number	pack quantity
052.18.001	1 piece



NON-RETURN VALVE - "polypropylene"

➤ Manufactured from polypropylene for usage with tubing connections and vacuum systems.

➤ Prevents water back flow when the pressure declines. Useful for any tubing system and vacuum line.

➤ Max. safe working pressure at ambient temperature: 2,0 bar. Min. safe working pressure at ambient temperature: 0,07 bar.

catalogue number	tube diameter	pack quantity
040.10.005	8 - 11 mm	1 piece

distillation & filtration & separation & sample preparation



**FUNNELS - "separating"
"squib" - "graduated"**

- Manufactured from heat resistant, durable borosilicate glass with graduation marks printed on the body according to ISO 4800.
- Thick wall and reinforced rim prevent breakage during washing and transportation.
- Perfectly grinded NS necks with smooth interior are manufactured according to DIN 12242 standard.
- Volume graduations and inscriptions are printed with white enamel.
- Supplied with P.E stopper and an interchangeable PTFE stopcock which does not require greasing.

catalogue number	volume	neck NS size	pack quantity
031.02.050	50 ml	NS 19/26	1 piece
031.02.100	100 ml	NS 19/26	1 piece
031.02.250	250 ml	NS 29/32	1 piece
031.02.500	500 ml	NS 29/32	1 piece
031.02.901	1000 ml	NS 29/32	1 piece
031.02.902	2000 ml	NS 29/32	1 piece



**FUNNELS - "separating"
"conical" - "graduated"**

- Manufactured from heat resistant, durable borosilicate glass with graduation marks printed on the body according to ISO 4800.
- Thick wall and reinforced rim prevent breakage during washing and transportation.
- Perfectly grinded NS necks with smooth interior are manufactured according to DIN 12242 standard.
- Volume graduations and inscriptions are printed with white enamel.
- Supplied with P.E stopper and an interchangeable PTFE stopcock which does not require greasing.

catalogue number	volume	neck NS size	pack quantity
031.04.050	50 ml	NS 19/26	1 piece
031.04.100	100 ml	NS 19/26	1 piece
031.04.250	250 ml	NS 29/32	1 piece
031.04.500	500 ml	NS 29/32	1 piece
031.04.901	1000 ml	NS 29/32	1 piece
031.04.902	2000 ml	NS 29/32	1 piece



**FUNNELS - "separating"
"cylindrical" - "graduated"**

- Manufactured from heat resistant, durable borosilicate glass with graduation marks printed on the body according to ISO 4800.
- Thick wall and reinforced rim prevent breakage during washing and transportation.
- Perfectly grinded NS necks with smooth interior are manufactured according to DIN 12242 standard.
- Volume graduations and inscriptions are printed with white enamel.
- Supplied with P.E stopper and an interchangeable PTFE stopcock which does not require greasing.

catalogue number	volume	neck NS size	pack quantity
031.06.050	50 ml	NS 19/26	1 piece
031.06.100	100 ml	NS 19/26	1 piece
031.06.250	250 ml	NS 29/32	1 piece
031.06.500	500 ml	NS 29/32	1 piece
031.06.901	1000 ml	NS 29/32	1 piece



**FUNNELS - "dropping"
"conical" - "graduated"**

- Manufactured from heat resistant, durable borosilicate glass with graduation marks printed on the body according to ISO 4800.
- Thick wall and reinforced rim prevent breakage during washing and transportation.
- Perfectly grinded NS necks with smooth interior are manufactured according to DIN 12242 standard.
- Volume graduations and inscriptions are printed with white enamel.
- Supplied with P.E stopper and an interchangeable PTFE stopcock which does not require greasing.

catalogue number	volume	neck NS	cone NS	pack quantity
032.01.050	50 ml	19/26	29/32	1 piece
032.01.100	100 ml	19/26	29/32	1 piece
032.01.250	250 ml	29/32	29/32	1 piece
032.01.500	500 ml	29/32	29/32	1 piece
032.01.901	1000 ml	29/32	29/32	1 piece



**FUNNELS - "dropping"
"cylindrical" - "graduated"**

- Manufactured from heat resistant, durable borosilicate glass with graduation marks printed on the body according to ISO 4800.
- Thick wall and reinforced rim prevent breakage during washing and transportation.
- Perfectly grinded NS necks with smooth interior are manufactured according to DIN 12242 standard.
- Volume graduations and inscriptions are printed with white enamel.
- Supplied with P.E stopper and an interchangeable PTFE stopcock which does not require greasing.

catalogue number	volume	neck NS	cone NS	pack quantity
032.02.050	50 ml	19/26	29/32	1 piece
032.02.100	100 ml	19/26	29/32	1 piece
032.02.250	250 ml	29/32	29/32	1 piece
032.02.500	500 ml	29/32	29/32	1 piece
032.02.901	1000 ml	29/32	29/32	1 piece



**FUNNELS - "dropping"
"cylindrical" - "graduated"
"with relief tube"**

- Manufactured from heat resistant, durable borosilicate glass with graduation marks printed on the body according to ISO 4800.
- Thick wall and reinforced rim prevent breakage.
- Perfectly grinded NS necks with smooth interior are manufactured according to DIN 12242 standard.
- Volume graduations and inscriptions are printed with white enamel.
- Supplied with P.E stopper and an interchangeable PTFE stopcock which does not require greasing.

catalogue number	volume	neck NS	cone NS	pack quantity
032.03.050	50 ml	19/26	29/32	1 piece
032.03.100	100 ml	19/26	29/32	1 piece
032.03.250	250 ml	29/32	29/32	1 piece
032.03.500	500 ml	29/32	29/32	1 piece
032.03.901	1000 ml	29/32	29/32	1 piece

distillation & filtration & separation & sample preparation

CENTRIFUGE - "mini"



- Compact and easy to use personal centrifuge for quick spin downs, micro-filter cell separations, and HPLC samples.
- Durable transparent and UV resistant polycarbonate lid and ABS resin body.
- DC motor accelerates the rotor to the set speed with low vibration and also with a quiet operation less than 45 dB noise level.
- Starts and reaches a maximum speed of 7.000 rpm in seconds.
- Multi voltage design guarantees stable running and high accuracy of speed.
- Featured with a door interlock system for extra safety.
- For user safety electronic brake immediately stops when lid opens.
- Rotor is seated on a tapered shaft which enables tool-free, fast and easy exchange.
- Supplied with two rotors and adapters to accommodate 0,5 ml and 1,5 ml and 2 ml tubes and also PCR tubes.



6 cavity rotor designed for 1,5 & 2.0 ml tubes directly.



16 cavity rotor designed for 0,2 ml PCR tubes which can also hold 2 x 8 PCR strips.

catalogue no	603.01.001
dimensions / weight (mm / kg)	175 x 140 x 117 / 0,5
voltage (V)	100 - 240
frequency (Hz)	50 / 60
speed (rpm)	7000
maximum RCF (xg)	2680
noise level (dB)	< 45
run time	continuous operation
rotor capacity	0,2 / 0,5 / 1,5 / 2,0 ml x 6 0,2 ml x 16 PCR strips 0,2 ml x 2 PCR 8 strips
standard accessories	16 cavity & 6 cavity rotors & adapters



Easy to start: Close the lid, the rotor starts and instantly reaches 7.000 rpm.



Easy to stop: Open the lid, the electrical brake immediately stops the rotor.

distillation & filtration & separation & sample preparation

CENTRIFUGE - "mini" - "high speed"



- Ideal centrifuge for fast spins for higher RCF requirement, for PCR protocols, for microfilter cell separations, clinical applications and HPLC protocols.
- Offers memory function up to 10 different programs.
- Featured with an explosion proof and fully enclosed strong inner structure for full safety.
- Brushless DC motor accelerates the rotor to the set speed with low vibration and also with a quiet operation less than 56 dB noise level.
- Air evacuation system ensures free air flow during high speed to prevent samples being over heated.
- User friendly large LCD display enables easy setting and reading of the functional parameters.
- Both RPM and RCF can be set and displayed. The parameters can be modified after the set speed is reached.
- Metal casing with low gravity, provides stable and reliable running at maximum speed.
- Starts and reaches the maximum speed of 15.000 rpm with max 15.100 RCF in seconds. Speed can be set with an accuracy of +/- 20 rpm.
- Timer can be set from 30 seconds to 99 minutes or continuous running. Timer starts once the target speed is reached for more accurate operation time.
- Offers quick spins by pressing and holding the "pulse" key.
- Multi voltage design guarantees stable running and high accuracy of speed.
- Featured with a dual door interlock system for twice safety. Electronic brake immediately stops when lid opens for user safety.
- Lid is released automatically when the rotor stops.
- Rotor is sealed on a tapered shaft which enables tool-free, fast and easy exchange.
- Supplied with a 12 cavity rotor designed for 1,5&2.0 ml tubes directly.



User friendly large LCD display enables easy setting and reading of the functional parameters. Both RPM and RCF can be set and displayed.



High strength plastic rotor with excellent balance offers a stable operation. 12 cavity rotor designed for 1,5 & 2.0 ml tubes directly.

catalogue no	603.02.001
dimensions / weight (mm / kg)	255 x 245 x 140 / 6,0
voltage (V)	100 - 240
frequency (Hz)	50 / 60
maximum speed (rpm)	15000
maximum RCF (xg)	15100
speed accuracy (rpm)	± 20
increment (rpm)	100
noise level (dB)	< 56
run time	timer & continuous operation
rotor capacity	1,5 / 2,0 ml x 12
standard accessories	12 cavity rotors
safety devices	door interlock over speed detection over temperature detection automatic internal diagnosis

distillation & filtration & separation & sample preparation



CENTRIFUGE - "clinical"

- Ideal centrifuge for fast separation of serum, plasma, urea, blood samples and other routine applications in medical, research and chemical laboratories.
- Explosion proof and marked as CE, cTUVus, and FCC. MCA test according to IEC/EN61010-2-10.
- Brushless DC motor accelerates the rotor to the set speed with low vibration and also with a quiet operation less than 56 dB noise level.
- User friendly large LCD display enables easy setting and reading of the functional parameters.
- Both RPM and RCF can be set and displayed. The parameters can be modified after the set speed is reached.
- Starts and reaches a maximum speed of 4.500 rpm with max 2.490 RCF in seconds. Speed can be set with an accuracy of +/- 20 rpm.
- Metal casing with low gravity, provides stable and reliable running at maximum speed.
- Timer can be set from 30 seconds to 99 minutes or continuous running. Timer starts once the target speed is reached for more accurate operation time.
- Short spin function is used for quick spins by pressing and holding the "pulse" key.
- Multi voltage design guarantees stable running and high accuracy of speed.
- Featured with a dual door interlock system for twice safety.
- Electronic brake immediately stops when lid opens for user safety. Lid is released automatically when the rotor stops.
- The unique design guarantees stable running and high accuracy of the speed. High strength rotor and excellent balance technology guarantees a quiet and stable operation.
- Delivered complete with a 8 cavity angled rotor and suitable adaptors to be used with 15 ml conical tubes and all kinds of blood collection tubes.

catalogue no	603.05.001
dimensions / weight (mm / kg)	255 x 245 x 140 / 6,0
voltage (V)	220
frequency (Hz)	50
maximum speed (rpm)	4500
speed control (rpm)	increment of 100
maximum RCF (xg)	2490
RCF control (xg)	increment of 100
speed accuracy (rpm)	± 20
noise level (dB)	< 56
run time	30 sec. - 99 min. or continuous
acceleration / braking time (sec)	20 s ↑ 20 s ↓
safety devices	door interlock over - speed detection automatic internal diagnosis
additional features	sound alert function speed / RCF switch short time run function



High strength plastic rotor and excellent balance technology to guarantee a quiet and stable operation.

Delivered complete with a 8 cavity angled rotor and suitable adaptors to be used with 15 ml conical tubes and all kinds of blood collection tubes.



User friendly large LCD display offers easy identification of parameters and shows all informations including accumulated running time and last running parameters.

Both RPM or G-force can be set and displayed. Parameters can be modified after the set speed is achieved.



Featured with a dual door interlock system for twice safety.

Electronic brake immediately stops when lid opens for user safety.

Lid is released automatically when the rotor stops.



*cleaning & safety
protection & sterilization*



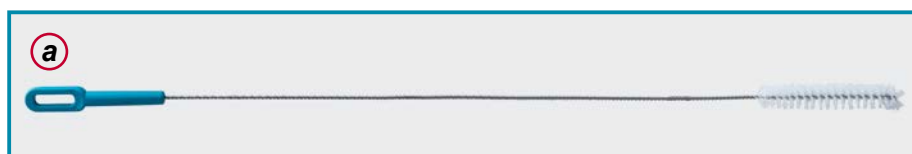
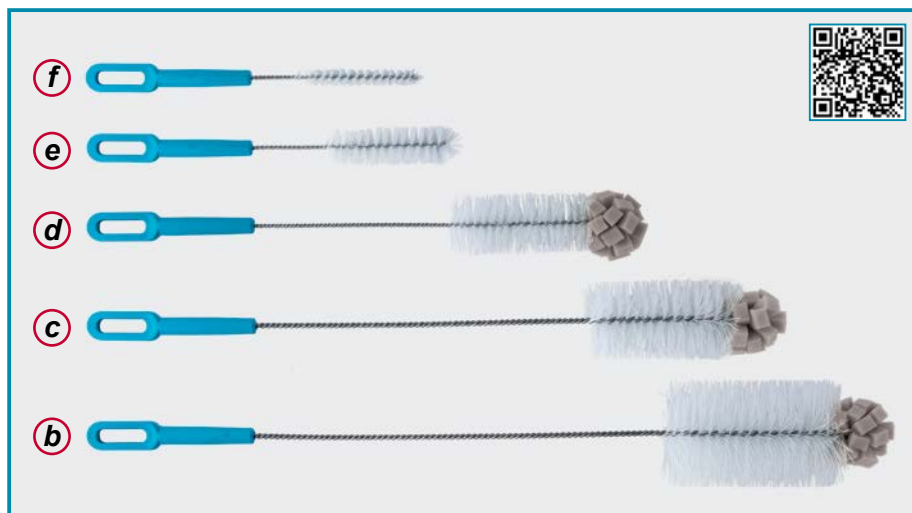

brush code	catalogue number	product descriptions	brush diameter	brush length	pack quantity
a	071.02.001	Burette and tubings cleaning brush	20 mm	125 mm	1 piece
b	071.02.002	Large size bottle cleaning brush	70 mm	130 mm	1 piece
c	071.02.003	Medium size bottle cleaning brush	50 mm	110 mm	1 piece
d	071.02.004	Small size bottle cleaning brush	40 mm	110 mm	1 piece
e	071.02.005	Common test tubes cleaning brush	25 mm	100 mm	1 piece
f	071.02.006	Narrow test tubes cleaning brush	12 mm	80 mm	1 piece



LABORATORY BRUSH "natural fibre / perlon"

- Excellent tools for washing and cleaning of all type of laboratory bottles, flasks, tubes, condensers, burettes etc.
- Brush material is manufactured from highest quality of fibre/perlon for long life cycle.
- Brush stem is manufactured from twisted steel wire.
- Brush handle is manufactured from polypropylene and offers extreme easy handling and use of the brush.
- Unique handle design enables hanging of the brush to a convenient place for easy reach.
- Spherical sponge top part enables access to every corner of the labware and guarantees perfect cleaning results.

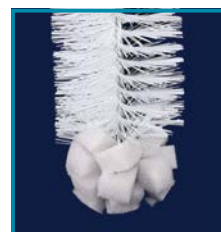

Spherical sponge top part enables access to every corner of the labware and guarantees perfect cleaning results.

LABORATORY BRUSH "hinged & swivel head"

- Specially recommended for curved and cornered labware such as round bottom flasks.
- Uniquely designed convex swiveling brush head gets contact with all over the surface of the flask including difficult curves and corners and enables thorough cleaning.
- The brush head has a slightly convex shape for fast and effective cleaning even also at heavy soiled flasks.
- Strong yet flexible bristles provide long lasting trouble free life cycle. Good grip due to the solid and long wooden handle.
- The swivel brush part fits through NS 29/32 or larger or any non tapered neck with a diameter 24 mm or larger.
- 360 mm length brush handle offers easy touch of the bottoms of larger size flasks.

catalogue number	swivel head size	handle length	pack quantity
071.03.001	21x44x24 mm	360 mm	1 piece

LABORATORY BRUSH - "non - absorbant foam"

➤ **Manufactured from non-absorbant reinforced foam which will not absorb water and not become soggy even after multiple use.** ➤ **Essentially much longer lasting than other common brushes.** ➤ **Cleans laboratory glassware with minimum effort and maximum efficiency.** ➤ **Will not chip, break or scratch laboratory glassware, can also be safely used on plastic labware.** ➤ **Ergonomically designed wide handles enable easy rotating of brush.**

LABORATORY BRUSH - "flexible"

- Specially recommended for labware with narrow neck and wider base such as flasks, erlenmeyers, bottles etc.
- Feautured with a flexible body which perfectly adapts to the base and interior wall shape of the vessel to be cleaned.
- Offers perfect cleaning also for large size labwares with it's total lenght 370 mm and brush diameter 20 mm.

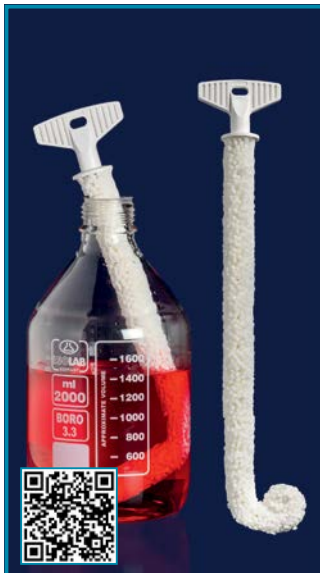

catalogue number	pack quantity
071.05.001	1 piece

LABORATORY BRUSH - "round head"



- Specially recommended for all labware with cylindrical form such as cylinders, beakers, vertical tanks and other similar flasks.
- Guarantees perfect cleaning with it's sprerical cleaning brush part that touches every surface and corner of labware's interior.

catalogue number	brush size	brush diameter	total length	pack quantity
071.05.002	short	60 mm	350 mm	1 piece
071.05.003	long	70 mm	400 mm	1 piece

LABORATORY BRUSH - "for tubings"

- Specially recommended for hoses, tubings with diameter from 12 mm to 25 mm.
- Perfectly adapts to the rounding of the tube and flexible long handle enables even the round labware can be cleaned effectively.

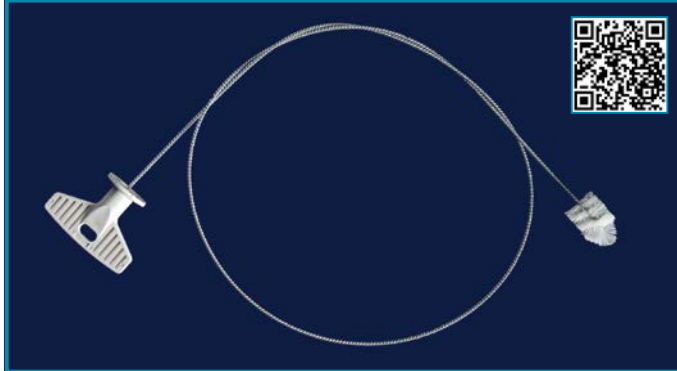

catalogue number	brush diameter	total length	pack quantity
071.05.005	20 mm	1200 mm	1 piece

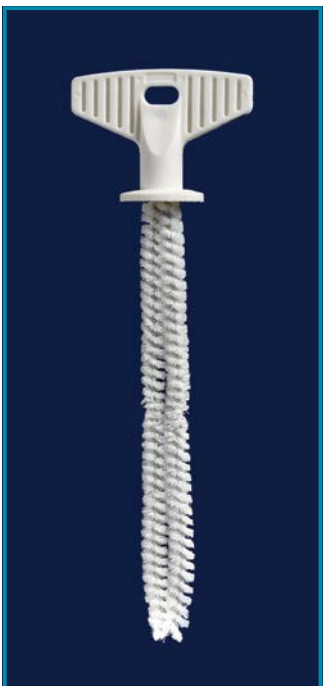

LABORATORY BRUSH - "for tubes"

- Specially recommended for tubes due to the unique design which fits to all tube sizes from the smallest to the largest diameter.
- Consists of two parallel cleaning brush rods hold be a single head. The rods can be pulled and moved to sides.
- This feature enables the contact of the brush all over the interior surface of different tubes with different diameters.
- This tube brush with it's unique features guarantees fast and very effective cleaning of all tubes with different size and lenght.

catalogue number	brush diameter	total length	pack quantity
071.05.004	25 mm	180 mm	1 piece





Draining racks are supplied without packs pegs.
Pegs should be ordered separately.

DRAINING RACK

- These professional draining racks cover all the cleaning demands of a modern laboratory.
- Manufactured from water resistant, sturdy polyresin thick plate for life time usage.
 - **Medium size rack with 72 peg compartments**
- **Alternative 2 racks:**
 - **Large size rack with 122 peg compartments**
- The collecting tray at the bottom part collects the drained water and dispenses with the help of a hose supplied as a standard to the rack.
- Supplied complete with wall mounting kit, draining hose and fixing template.
- Draining racks are supplied with 16 small and 16 large pegs. Please kindly order for more pegs separately.



The collecting tray at the bottom part collects the drained water and dispenses by a hose supplied as a standard to the rack.

catalogue number	rack width	rack height	peg quantity	pack quantity
071.01.002	500 mm	610 mm	72	1 piece
071.01.003	500 mm	1010 mm	122	1 piece

DRAINING PEGS

- Pegs are manufactured from ABS which is extremely resistant side effects. Pegs are supplied disassembled and can easily be inserted into the related compartments on the draining rack.

catalogue number	for flask neck diameter	peg type	peg form	pack quantity
071.01.101	15 mm & more	large	triangular	16 pieces
071.01.102	6 mm - 15 mm	small	round	16 pieces



PIPETTE WASHING SET

- Operates with syphon system and offers a gentle and effective cleaning of pipettes up to 600 mm height.
- Consists of two parts as: cleaning & washing unit and pipette holding basket unit.
- Easy to use; first fill the tank with water. The access water will be automatically drained out through a syphon system.
- Then insert the pipette basket filled with dirty pipettes ready for cleaning.
- The contaminated dirty water runs out of the system through a pipe line attached to the main body.

catalogue number	pack quantity
071.10.001	1 piece



DRAINING RACK

- Manufactured from high quality, chromated steel. Double shelf design offers practical use and best draining option with all size of glasswares.

catalogue number	dimensions	pack quantity
071.01.004	475 x 310 x 310 mm	1 piece



AUTOCLAVE - "vertical"

- This easy to use, desktop, vertical autoclave offers practical solutions for sterilization.
- Safe, reliable and complete sterilization is guaranteed by immersion type electrical heating elements with high thermal efficiency.
- Sterilization chamber is manufactured from single piece stainless steel of 2,5 mm thickness.
- "Over-temperature" and "over-pressure" systems ensures highest safety level during operation run cycle.
- Silicone sealing ring guarantees excellent and safe closure and prevents steam leakage offering always clean and dry environment.
- Featured with a LED screen electronic timer enabling the time control between 1 - 99 minutes.
- Operative pressure clearly visible and controllable by a pressure gauge. Also featured with buzzer type alarm function for low water level.



"Over-temperature" and "over-pressure" systems ensures highest safety level during operation cycle.



TEST INDICATOR - "for steam sterilization"

➤ Specially designed for steam sterilisation tests. Consist of a rolled paper with temperature sensitive stripes on the surface.

➤ These stripes changes color once the ambient temperature reaches steam sterilisation temperature level.

➤ Irreversible color change from pale yellow to dark brown proves that the sterilisation protocols has been successfully covered.

➤ Adhesive at the back of the rolled paper strongly adheres to paper, plastic and textile surfaces yet easily removable without leaving any trace.

➤ Slightly crepped paper surface allows easy marking by any kind of pen.



before sterilization

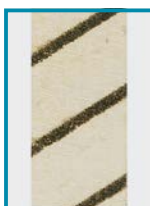

after sterilization



Featured with a LED screen electronic timer enabling the time control between 1 - 99 minutes.

catalogue no	601.02.024
external dimensions (mm)	390 x 400 x 690
chamber dimensions (mm)	Ø280 x 310
chamber volume (L)	24
voltage (V)	220
frequency (Hz)	50 / 60
power (kW)	2,0
sterilizing (pressure / temp.)	100 - 120 KPa / 121°C 200 KPa / 127°C
water tank capacity (lt)	1,5
water consumption / cycle (lt)	0,4
internal material	stainless steel
external material	stainless steel
safety devices	over heat protection over pressure protection leakage breaker safety valve door lock system

catalogue number	roll width	roll length	pack quantity
101.03.001	19 mm	50 m	1 piece

ULTRASONIC CLEANERS - "standard"



- Offer ideal solutions for intensive and gentle cleaning of glassware, metal parts, electronic components, instruments.
- Featured with robust stainless steel vibration tank and housing with handles to carry on both sides. Tubs made of cavitation – proof stainless steel.
- Assures uniform, precision cleaning over the entire surface, and consistent cavitation that reaches and cleans even tiny crevices on the parts.
- Membrane keypad with digital LED panel for simultaneous display for set & actual temperature and set & actual time.
- Memory function keeps settings in memory for frequent and repeated operations.
- Pause function gives an option to pause and restart the operation at any desired moment.
- High heating performance ensures short warm-up period.
- Heating can be controlled up to 80°C with 1°C increments.
- Time control is possible between 1-60 minutes with 1 minute increments.
- Delivered complete with stainless steel lid and stainless steel "standard density" basket.
- Ultrasonic cleaners from 10 to 28 L are featured with a drainage valve for removal of the water from the tank.

catalogue no	621.05.001	621.05.003	621.05.006	621.05.010	621.05.015	621.05.022	621.05.028
ext. dimensions (mm)	175 x 155 x 225	265 x 165 x 225	365 x 175 x 285	420 x 265 x 285	365 x 340 x 365	540 x 340 x 365	540 x 340 x 365
tank dimensions (mm)	150 x 138 x 65	238 x 138 x 100	302 x 152 x 150	302 x 239 x 150	325 x 295 x 150	502 x 298 x 150	502 x 298 x 200
tank volume (L)	1,3	3,0	6,0	10,0	15,0	22,0	28,0
ultrasonic power (W)	60	120	180	240	360	360	480
frequency (kHz)	40	40	40	40	40	40	40
heating power (W)	60	180	300	300	500	600	600
max. heating (°C)	80	80	80	80	80	80	80
heating accuracy (°C)	± 1	± 1	± 1	± 1	± 1	± 1	± 1
time control (min)	1 - 60	1 - 60	1 - 60	1 - 60	1 - 60	1 - 60	1 - 60
drainage valve	N/A	N/A	N/A	yes	yes	yes	yes
standard accesories	basket & lid	basket & lid	basket & lid	basket & lid	basket & lid	basket & lid	basket & lid



Ultrasonic cleaners from 10 to 28 L featured with a drainage valve for removal of dirty water.



Featured with sturdy, stainless steel handles for safe and easy hold of the ultrasonic bath.

cleaning & safety & protection & sterilization



ULTRASONIC CLEANERS "with sweep & degass & pulse functions"

- These ultrasonic cleaners are features with "sweep", "degass" and "pulse" functions. Most specks are similar to standard ultrasonic cleaners.
- They also offer ideal solutions for intensive and gentle cleaning of glassware, metal parts, electronic components, instruments.
- Featured with robust stainless steel vibration tank and housing with handled to carry on both sides. Tubs made of cavitation - proof stainless steel.
- Assures uniform, precision cleaning over the entire surface, and consistent cavitation that reaches and cleans even tiny crevices on the parts.
- Memory function keeps settings in memory for frequent and repeated operations.
- Pause function gives an option to pause and re-start the operation at any desired moment.
- High heating performance ensures short warm-up period. Heating can be controlled up to 80°C with 1°C increments.
- Time control is possible between 1-60 minutes with 1 minute increments.



Membrane keypad with digital LED panel for simultaneous display for set & actual temperature and set & actual time.



catalogue no	621.06.003	621.06.006	621.06.010
ext. dimensions (mm)	265x165x225	365x175x285	420x265x285
tank dimensions (mm)	238x138x100	302x152x150	302x239x150
tank volume (L)	3,0	6,0	10,0
ultrasonic power (W)	160	240	320
frequency (kHz)	37	37	37
heating power (W)	150	270	310
max. heating (°C)	80	80	80
heating accuracy (°C)	± 1	± 1	± 1
time control (min)	1 - 60	1 - 60	1 - 60
drainage valve	N/A	N/A	yes
standard accesories	basket & lid	basket & lid	basket & lid

ULTRASONIC CLEANER DETERGENT



➤ Higly effective special cleaner for cleaning items in ultrasonic baths intensively.

➤ Removes distillation deposits, tars, grease, resins, adhesives, fats, oils, metal oxides, mineral dirt and similar soiling without leaving traces only with consumption of less than 2 % of the tank volume.

➤ Supports ultrasonic cleaning process, ideal for washing operations which are normally too difficult for ultrasonics alone.

➤ Extremely gentle on ware with almost neutral pH value. Fully water soluble, low-foaming, low phosphate content, non-combustible, no gas formation, non-toxic, biodegradable.

➤ Although can be used cold water, using in hot water intensifies and accelerates the cleaning effect.

catalogue number	pack specs	pack quantity
621.01.101	PP bottle	1 L

cleaning & safety & protection & sterilization



BRUSH "for intensive cleaning"

- Specially recommended for all applications which require intensive cleaning.
- Brush part consists a mixture of natural hair and very soft bristles providing long lasting trouble free life cycle.
- Ergonomic handle offers the best grip option.
- Can also be used for cleaning larger surfaces such as benches, floor.

catalogue number	pack quantity
071.06.001	1 piece



BRUSH "for dish washing"

- Specially recommended for all applications such as dish washing and intensive cleaning of large surfaces.
- Brush part consists several layers of sponges with different density and also a scrubbing layer at the bottom line.
- Handle offers the best grip option.

catalogue number	pack quantity
071.06.002	1 piece



WIPES - "microfibre"

- Manufactured from microfibre textile with high tensile strength with 300 x 400 mm dimensions.
- Specially recommended for lifting and trapping dirt from surfaces for fast and efficient cleaning. No chemicals are required during cleaning.
- Absorbs and retains up to 8 times its weight. Can be washable hundreds of times without getting tired.
- Supplied as two wipes: one for glass surfaces, the other for general use.

catalogue number	pack quantity
071.07.003	set of 2

TISSUES - "cellulose" - "paper"

- Manufactured from non-chlorine bleached cellulose as double ply sheets with 195 x 195 mm dimensions.
- Ultra soft, chemically inert, highly absorbent and low lint cellulose offers the best reliable results.
- Specially recommended for wiping and cleaning of labware and also for other use such as cleaning pipettes and slides, wiping small amounts of liquids etc.
- Supplied in a handy dispenser box for hygienic storage and easy removal.

catalogue number	pack quantity
080.65.002	100 pieces



CLEANING TOWEL

- Manufactured from pure cellulose with high degree of water absorption.
- Offers cost effective solutions to other alternatives.
- High capacity water absorption level guarantees multi-usage of these towels.
- Cut and packed according to the interior dimensions of the towel dispenser.

catalogue number	towel dimensions	pack quantity
080.65.004	230 x 220 mm	200 pieces



TOWEL DISPENSER

- Designed to be used with paper towel dispensers. Can carry 200 towels at one time.
- Paper towels can be pulled from the bottom part for fast and easy dispense.
- Acrylic front panel enables visual control of the towel quantity.
- Can be easily mounted on the wall for practical use.

catalogue number	dimensions	pack quantity
080.67.001	266 x 287 x 107 mm	1 piece



TRAYS - "polypropylene"

- Manufactured from polypropylene for multi-purpose use. Injection moulded as one piece, durable and featured with a strong rim around the body.
- Usable with food-stuff, hygienic and easy to clean. Easily stackable for reducing storage space.

catalogue number	base dimensions	height	pack quantity
062.40.901	183 x 127 mm	50 mm	1 piece
062.40.902	255 x 180 mm	60 mm	1 piece
062.40.905	355 x 245 mm	70 mm	1 piece



TRAYS - "stainless steel"

- Manufactured from high quality, chemical and corrosion resistant AISI 304 grade stainless steel for multipurpose use.
- Robust and seamless construction guarantees long life cycle. Smooth polished surfaces provide fast and easy cleaning.

catalogue number	base dimensions	height	pack quantity
062.42.910	400 x 500 mm	50 mm	1 piece
062.42.915	450 x 600 mm	50 mm	1 piece
062.42.920	500 x 700 mm	50 mm	1 piece



BUCKET

- Buckets with lid are manufactured from HD-PE. Featured with a sturdy carry handle for easy lift and with a lid for complete closure of the bucket.

catalogue number	volume	top dia. x height	pack quantity
062.60.901	1 L	120 x 122 mm	10 pieces
062.60.902	2 L	165 x 138 mm	10 pieces
062.60.903	3 L	190 x 132 mm	10 pieces
062.60.905	5 L	210 x 171 mm	10 pieces
062.60.909	9 L	259 x 226 mm	10 pieces
062.60.918	18 L	310 x 275 mm	10 pieces

catalogue number	volume	top dia. x height	pack quantity
062.61.909	9 L	265 x 250 mm	1 piece
062.61.914	14 L	302 x 295 mm	1 piece



SAFETY BOXES

- Manufactured from polypropylene according to UN3291 standard. Labelled according to international standards. Resistant to solvents. Thick wall offers puncture resistance to all means.
- Ideal to safe disposal of contaminated products such as needles, syringes, lancets etc.
- For safety reasons the main lid is permanently locked and sealed once pressed on the body. Lid provided with a built-in flat opening for waste entry having a temporary and permanent closing system.

catalogue number	volume	dimensions	pack quantity
062.80.901	1.3 L	70 x 115 x 165 mm	1 piece
062.80.903	3.0 L	180 x 215 x 110 mm	1 piece
062.80.905	5.0 L	175 x 215 x 185 mm	1 piece
062.80.912	12.0 L	225 x 270 x 265 mm	1 piece
062.80.925	25.0 L	270 x 300 x 435 mm	1 piece

cleaning & safety & protection & sterilization

GOGGLE



➤ Comfortable, ergonomically designed goggle offers unrestricted 180° panoramic visibility. Also suitable for wearing over prescription spectacles.

➤ Ultra clear, scratch-proof, anti-fog visor guarantees very high mechanical stability.

➤ Provides a modern styling in combination with comfort. Offers supreme wearing comfort due to the light body.

➤ Can be adjusted quickly providing reliable all-round protection. Adapts to individual face curvature providing complete side protection

catalogue number	pack quantity
080.40.007	1 piece



Additional ventilation via integrated air channels enables optimal indirect ventilation ensuring mist-free usage.



SAFETY SPECTACLES

➤ Manufactured from ultra clear, impact resistant, UV protected polycarbonate according to CE EN166 standard.

➤ Sporty and modern design with high mechanical strength.

➤ Featured with a clear scratch-proof, anti-fog, lens with 100% UV protection.

➤ Large panorama lens offer 180° extreme broad field of vision.

➤ Offers supreme wearing comfort with 18 gram light weight.

➤ Ergonomically design and slim nose bridge offers perfect fit.

➤ Different frame colors offer visual sorting and better organising.



SAFETY SPECTACLES

➤ Manufactured from ultra clear, impact resistant, UV protected polycarbonate according to CE EN166 standard.

➤ Ergonomic design guarantees perfect fit. Large panorama lens offer 180° extremely broad field of vision.

➤ Recommended for factory visits, assembly lines and laboratory routine work. Suitable for wearing over common prescription spectacles.

➤ Guarantees full protection including eyebrow and eye sides. Offers supreme wearing comfort with 39 gram light weight.



spectacle blue frame	spectacle purple frame	spectacle ruby frame	spectacle green frame	pack quantity
080.40.002B	080.40.002P	080.40.002R	080.40.002G	1 piece

spectacle clear lens	pack quantity
080.40.003	1 piece

SAFETY SPECTACLES



➤ Manufactured from ultra clear, impact resistant, UV protected polycarbonate according to CE EN166 standard. Ergonomic design guarantees perfect fit.

➤ Featured with a clear scratch-proof, anti-fog, lens with 100% UV protection. Guarantees full protection of eyes including eyebrow and eye sides.

➤ Offers supreme wearing comfort with 27 gram light weight. Large panorama lens offer 180° broad field of vision.

➤ 30 degree up/down movable side arm also guarantees the optimum lens angle adjustment for the best configuration.

➤ Featured with side arm length adjustment with integrated stop lock for perfect fit of the spectacle to the face and optimum coverage of the eyes.

➤ Soft silicone ear pads at the side arms offer supreme wear comfort and pressure-free fit.

spectacle
clear lens

080.40.004

pack
quantity

1 piece

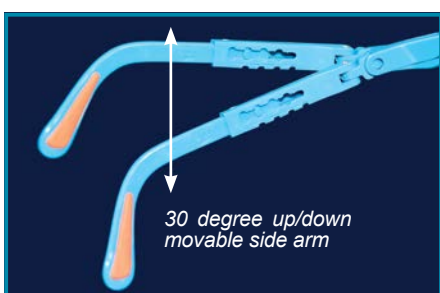

30 degree up/down movable side arm also guarantees the optimum lens angle adjustment.



spectacle
with clear lens

080.40.001

spectacle
with dark lens

080.40.011

SAFETY SPECTACLES



➤ Manufactured from ultra clear, impact resistant, UV protected polycarbonate according to CE EN166 standard.

➤ Featured with a clear scratch-proof, anti-fog, lens with 100% UV protection.

➤ Offers modern styling and very high mechanical strength and full protection to eyes with wide curved lens.

➤ Ergonomic design guarantees perfect fit. Large panorama lens offer 180° extremely broad field of vision. Offers supreme wearing comfort with 27 gram light weight.

➤ 30 degree up/down movable side arm also guarantees the optimum lens angle adjustment for the best configuration.

➤ Featured with side arm length adjustment with integrated stop lock for perfect fit of the spectacle to the face.

➤ Soft silicone ear pads at the side arms offer supreme wear comfort and pressure-free fit. Soft silicone nose loops prevent slipping and ensure comfortable sit on the nose.

➤ Spectacle with a dark lens offers UV 400 protection against direct sunlight exposure.

➤ Spectacle with a yellow lens offers UV 254 protection against laser and UV light.

spectacle
with yellow lens

080.40.021

pack
quantity

1 piece

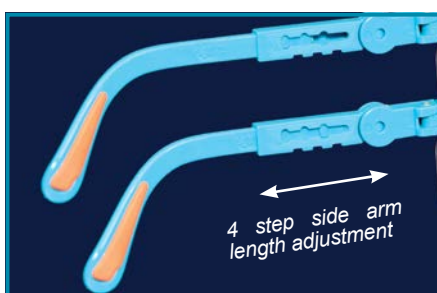

3 step side arm length adjustment for perfect fit to the face and optimum coverage of the eyes.



Soft silicone ear pads at the side arms offer supreme wear comfort and pressure-free fit.



SAFETY SHIELD

- Manufactured from polypropylene with integrated forehead safety cover.
- Provides excellent protection of full face against chemical splashes and flying objects.
- 1,5 mm thick fold-up protective visor manufactured from ultra clear acrylate with extra clear vision in all angles.
- Can be worn on the masks, goggles and spectacles. Ultra light weight guarantees full comfort.
- Rotating fastener for easy and fast adjustment to individual head shapes and sizes.
- Variable lift-up mechanism with locking option at any desired position and angle offers practical use.
- Soft sweat band eliminates sweat drops and offers comfortable use.

catalogue
number

080.40.010

pack
quantity

1 piece



Variable lift-up mechanism with locking at any position. Soft vinyl band offers comfortable use.



EAR PLUGS

- Manufactured from non-allergic, very soft, comfortable to wear PU foam with excellent sound insulation.
- Unique design offers wearing comfort even when worn extended hours.
- Optimised bell shape guarantees perfect fit even to ears with smaller auditory canals with a simple insertion.
- Once used seals the ear channel without the risk of slipping out.
- Featured with a cord fixing two plugs each other reducing the risk of loss. Easy to store when not in use.

catalogue
number

069.04.001

pack
quantity

set of 2



Illumination angle is adjustable in all directions by swivel mechanism.



EAR MUFF

- Low weight ear muff consists of two part ear pad with well ventilated and soft cushions.
- Offers perfect noise isolation and protection in extremely noisy environments.
- Steel suspensions headband system resistant to bending and providing comfortable pressure on ears.
- Quick-click adjustment enables headbands to adapt quickly to all head shapes and sizes and offers exceptional wearing comfort.
- Ear pads can be folded when not in use for protection against dust and other effects.

catalogue
number

069.04.002

pack
quantity

1 piece

LED LIGHT SOURCE

- Offers perfect illumination at dark working environments.
- Featured with a side clamp for easy and practical attachment of the light source to spectacles.
- Supplied with easily replaceable batteries with long life cycle.

catalogue
number

069.03.005

pack
quantity

1 piece

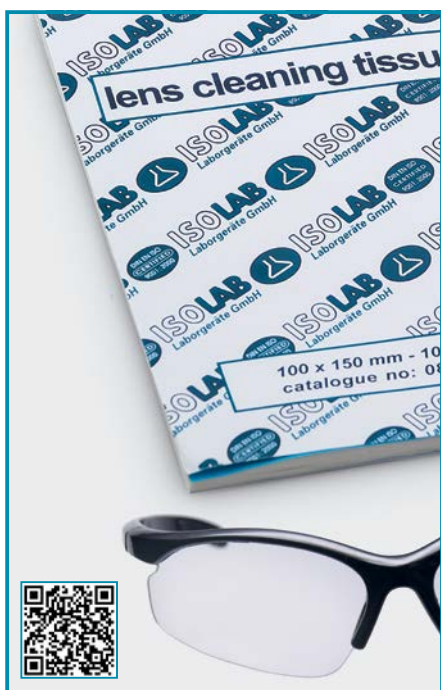

CLEANING TISSUES

- Manufactured from very thin best quality paper based on 100 % manile fibre. Cut with dimensions 100 x 150 mm.
- Guarantees fast and very effective cleaning of spectacles, goggles, microscope objectives, binoculars and all similar optical lens involved items.
- Never leaves any fibers or dust on the cleaned surface.
- These papers never scratches and damages the surfaces. They guarantee non-abrasive cleaning.
- Supplied in a handy booklet of 100 tissue sheet for hygienic storage and for easy dispensing.

catalogue number	dimensions	pack quantity
080.65.003	100 x 150 mm	1 booklet



CABINET

- Manufactured from crystal clear acylic with excellent field of vision for storing spectacles.
- Guarantees safe storage of spectacles from dust and other enviromental effects.
- Also can be used to store similar size of other type objects. 4 shelves with generous openings provide easy and safe access to partitions.
- Cover is featured with easy opening hinged lid. Magnetic clasp on the lid guarantees safe closure of the cabinet.
- Once opened, the lid stands open and enables easy filling and dispensing.
- Delivered with necessary attachment screws to be mount to the wall.



ULTRASONIC BATH

- Designed for intensive and gentle cleaning of small size objects such as spectacles.
- Assures uniform, precision cleaning over the entire surface.
- Featured with a digital LED panel for set & actual time.

catalogue no	621.08.001
ext. dimensions (mm)	205 x 145 x 125
tank dimensions (mm)	168 x 110 x 52
tank volume (L)	0,6
voltage (V)	110 - 220
frequency (Hz)	50 / 60
ultrasonic power (W)	35
frequency (kHz)	42
time control (sec)	60/120/180/240/300

ANTIFOG SET

- Offers 24 hour protection against fogging and keeps the spectacles always with a clear visibility.
- Set consists of 1 x spray unit with antifogging solution and 1 x cleaning ped.
- The application is very simple and effective. Just press the vaporisation button of the spray unit and spread of the antifogging solution all over the spectacle lens.
- Than wipe and clean the lens with the help of the provided cleaning ped.

catalogue number	pack quantity
080.40.102	1 piece



Holes at the corners of the frame provides wall mounting option



Magnetic clasp on the lid guarantees safe closure of the cabinet.

catalogue number	shelf quantity	external dimensions	pack quantity
080.40.101	5	110x260x400 mm	1 piece



EYE WASH BOTTLES - "standard size"



➤ Accidents can and do happen anytime. Every laboratory should have an emergency eye wash station for immediate access.

➤ Body manufactured from flexible and easy to squeeze polyethylene. The spray head and other parts manufactured from polystyrene.

➤ The spray head fits securely around the eye socket to hold eyelid in an open position during application.

➤ Eye wash bottle with 660 ml volume capacity provides a soft, broad and effective spray with a single action.

➤ The spray head has a perforated plate to break up the stream providing a gentle spray to the eye.

➤ A capped air vent valve prevents drawback of the contaminated eye wash back to the reservoir.

➤ Snap-on cap covers the spray head in a hygienic way and guarantees perfect protection of inside from dust and other environmental effects.

➤ Contaminated used solution exits through a drain tube which rotates in any direction.

➤ Eye wash bottle filled with sterile saline solution

➤ Alternative 2 bottles:

➤ Eye wash bottle filled with sterile neutralisation solution

catalogue number	solution descriptions	pack quantity
069.03.660	with 0,9 % saline rinsing solution	1 piece
069.04.660	with 4,9 % phosphate buffer neutralisation solution	1 piece

069.05.660 / empty bottle without solution / 1 piece



Eye wash bottle provides a soft, broad and excellent, effective spray with a single action.



Snap-on cap covers the spray head in a hygienic way and guarantees perfect protection of inside.



Bottle can be used also even when the injured person is lying down with the help of a sliding valve.



The spray head has a perforated plate to break up the stream providing a gentle spray to the eye.



The spray head fits securely around the eye socket to hold eyelid in an open position during application.



Contaminated used solution exits through a drain tube which rotates in any direction with 180 degree.

EYE WASH BOTTLES - "compact size"

- Manufactured as a personal eye wash bottle for emergency use.
- Ideal size for persons being frequently present in different risky working areas.
- Compact size with 175 ml volume capacity offers easy carry in a jacket pocket.
- The spray head fits securely around the eye socket to hold eyelid in an open position during application.
- Eye wash bottle provides a soft, broad and effective spray with a single action.
- The spray head has a perforated plate to break up the stream providing a gentle spray to the eye.
- A capped air vent valve prevents drawback of the contaminated eye wash back to the reservoir.
- Snap-on cap covers the spray head in a hygienic way and guarantees perfect protection of inside from dust and other environmental effects.
- Contaminated used solution exits through a drain tube which rotates in any direction.

➤ Eye wash bottle filled with sterile saline rinsing solution

➤ Alternative 2 bottles:

➤ Eye wash bottle filled with sterile neutralisation solution

catalogue number	solution descriptions	pack quantity
069.03.175	with 0,9 % saline rinsing solution	1 piece
069.04.175	with 4,9 % phosphate buffer neutralisation solution	1 piece

069.05.175 / empty bottle without solution / 1 piece

sterile saline rinsing solution

- Sterile saline rinsing solution contains 0,9% sodium chloride. Helpful in rinsing away dust, debris and other harmful irritants.
- Does not involve any side effects since the pH value is similar to that of human tears.
- Prevents the foreign bodies from sticking into the eye and causing serious harm.
- Does not contain pathogens that could cause infection, and will not damage eye or skin tissue during prolonged flushing.

sterile neutralisation solution

- When acids and alkalis contact the eyes or skin damage can start immediately.
- pH neutralising solution contains a sterile 4,9% phosphate buffer solution.
- Helpful in rinsing and neutralisation of acids and alkalis and other chemical contaminants to a harmless level in a very short time period.
- It is recommended to rinse the eye with saline solution after treatment with pH neutralisation solution.



Compact size offers easy carry in a jacket pocket.

BOTTLE STAND - "for eye wash bottle"



- For keeping eye wash bottles always "ready-for-use" stage.
- Keeps the bottle stable at his nest and guarantees easy and fast access to the bottle.
- Featured with a mirror and "how-to-use" instructions printed on the body.
- User looks directly into a mirror during rinsing.
- Supplied with necessary screw set for mounting on the wall.

catalogue number	pack quantity
069.05.001	1 piece

User looks directly into a mirror during rinsing. Focusing on the mirror with the eye lid open helps overcome the blinking reflex.

cleaning & safety & protection & sterilization



GLOVES - "nitrile" - "0,06 mm standard thickness"

- Manufactured pure nitrile free from phthalate softeners and latex proteins which cause allergy to the skin.
- Provides a standard thickness of 0,06 mm which is recommended for daily laboratory use.
- Classified as CE category 1. Tested in accordance with EN420:2003 standard.
- Provided with AQL 1,5 offering the highest level of protection according to EN374-2:2003 against penetration of microorganisms.
- 40 % more stronger and 60 % leaner than latex gloves.
- Provides full protection against wide range of chemicals including cytotoxic drugs.
- Easy to wear. Unique production techniques offer excellent mechanical strength providing multi-use options.
- Excellent fit to the hands guarantees maximum comfort.
- Slightly textured finger parts guarantee excellent grip option.

catalogue number	size	color	AQL	length	thickness	pack quantity
080.15.001	Small (7)	purple	1.50	240 mm	0,06 mm	100 pieces
080.15.002	Medium (8)	purple	1.50	240 mm	0,06 mm	100 pieces
080.15.003	Large (9)	purple	1.50	240 mm	0,06 mm	100 pieces
080.15.004	X Large (10)	purple	1.50	240 mm	0,06 mm	100 pieces

GLOVES - "nitrile" - "0,12 mm extra thickness"

- Manufactured pure nitrile free from phthalate softeners and latex proteins which cause allergy to the skin.
- Provides extra thickness of 0,12 mm which is recommended for daily laboratory use.
- Thick gloves are specially designed for life science, biomedical research, forensic science and drug handling applications.
- **Extra thickness guarantees extra safety.**
- Classified as CE category 1. Tested in accordance with EN420:2003 standard.
- Provided with AQL 1,5 offering the highest level of protection according to EN374-2:2003 against penetration of micro-organisms.
- 40 % more stronger and 60 % leaner than latex gloves.
- Provides full protection against wide range of chemicals including cytotoxic drugs.
- Easy to wear. Unique production techniques offers excellent mechanical strength providing multi-use options.
- Excellent fit to the hands guarantee maximum comfort. Slightly textured finger parts guarantee excellent grip option.

catalogue number	size	color	AQL	length	thickness	pack quantity
080.16.001	Small (7)	blue	1.50	240 mm	0,12 mm	100 pieces
080.16.002	Medium (8)	blue	1.50	240 mm	0,12 mm	100 pieces
080.16.003	Large (9)	blue	1.50	240 mm	0,12 mm	100 pieces
080.16.004	X Large (10)	blue	1.50	240 mm	0,12 mm	100 pieces



how to measure the right glove size?



- You have to select the right size of glove for your hands for your comfort.
- How you will select the right size of your glove? Measure the circumference of your dominant hand just below the fingers excluding the thumb. Compare the measurement to the size chart below to find your glove size.

XS	S	M	L	XL	XXL
(6" - 7")	(7" - 8")	(8" - 9")	(9" - 10")	(10" - 11")	(11" - 12")

GLOVES - "for safe handling"

➤ Manufactured from light weight 100 % cotton for multi-use. Unique design provides both left and right handed use.

➤ Easy to wear. Soft and flexible texture offers full comfort during use. Thick yet stretchable. Protects the sensitive skin.

➤ Makes unlined gloves easier to pull or to wear. Also prevents

from moderate levels of cold and heat. They are machine washable.

catalogue number	total length	pack quantity
080.13.001	260 mm	1 pair

**GLOVES - "for cold protection"**

➤ Economical and practical glove specially designed to work in cold environments.

➤ Recommended to be used in cold treatment plants, handling dry ice, working with coolents.

➤ Offers full protection very against even cold temperatures such as -140°C.

➤ Easy to wear. Soft and flexible texture offers full comfort during use. Thick yet stretchable. Protects the sensitive skin.

➤ The outer part of the glove is covered with a heat repellent leather. While the inner part is featured with soft and flexible protective textile.

➤ Even working at very low temperatures with extended hours it still remains flexible.

catalogue number	total length	pack quantity
080.10.201	450 mm	1 pair

**GLOVES - "for cold protection"**

➤ Specially designed to work in hazardous ultra-cold environments. Recommended to be used in cold treatment plants, handling dry ice, working with coolents. Not immersion in liquid nitrogen.

➤ Multi-layer construction provides light weight and full comfort during use. State-of-art material is breathable and stays always comfortable and dry.

➤ Offers full protection against even very cold temperatures such as -160°C. The innovative design offers superior thermal protection and maximum level of flexibility.

➤ Even working at very low temperatures with extended hours it still remains flexible.

catalogue number	glove length	pack quantity
080.10.101	450 mm	1 pair

GLOVES - "for heat protection"

➤ Manufactured from soft, flexible, heat resistant pliant terry cotton material.

➤ Easy to wear. Soft and flexible texture offers full comfort.

➤ The upper part is covered with a heat repellent material. While the palm part is manufactured from heat resistant soft and flexible leather.

➤ Offers maximum isolation and protection up to for limited time 250°C when working with autoclaves and muffle furnaces.

➤ Guarantees a long life cycle since they can be machine washable.

catalogue number	total length	pack quantity
080.11.001	380 mm	1 pair

cleaning & safety & protection & sterilization



GLOVES - "nitrile" - "for chemical protection"

- ▶ Manufactured from pure nitrile free from phthalate softeners and latex proteins.
- ▶ Classified as CE category III they can be used both at laboratories and industry.
- ▶ Offers excellent protection against alcohols, oils, greases, and hydrocarbons.
- ▶ Provide superior mechanical resistance against abrasion and perforation.
- ▶ Excellent fit and flexible texture offers full dexterity and comfort during use.
- ▶ Cotton flock liner inside the glove absorbs moisture and prevents sweating during use.
- ▶ Slightly textured fingers and palm guarantees excellent grip.

catalogue number	size	length	thickness	internal finish	external finish	pack quantity
080.21.007	7	320 mm	0,38 mm	flocked	embossed	1 pair
080.21.008	8	320 mm	0,38 mm	flocked	embossed	1 pair
080.21.009	9	320 mm	0,38 mm	flocked	embossed	1 pair



GLOVES - "nitrile" - "for chemical protection"

- ▶ Manufactured from pure nitrile free from phthalate softeners and latex proteins.
- ▶ Classified as CE category III they can be used both at laboratories and industry.
- ▶ Offers excellent protection against alcohols, oils, greases, and hydrocarbons.
- ▶ Provide superior mechanical resistance against abrasion and perforation.
- ▶ Excellent fit and flexible texture offers full dexterity and comfort during use.
- ▶ Cotton flock liner inside the glove absorbs moisture and prevents sweating during use.
- ▶ Slightly textured fingers and palm guarantees excellent grip.

catalogue number	size	length	thickness	internal finish	external finish	pack quantity
080.22.007	7	355 mm	0,85 mm	flocked	embossed	1 pair
080.22.008	8	355 mm	0,85 mm	flocked	embossed	1 pair
080.22.009	9	355 mm	0,85 mm	flocked	embossed	1 pair



GLOVES - "neopren" - "for chemical protection"

- ▶ Manufactured from polychloroprene which can cause allergy to the skin.
- ▶ Classified as CE category III they can be used both at laboratories and industry.
- ▶ Offer protection against semi-concentrated acids, concentrated bases, concentrated saline solutions, glycerol, solvents, alcohols, fats and oils.
- ▶ Excellent fit and flexible texture offers full dexterity and comfort during use.
- ▶ Cotton flock liner inside the glove absorbs moisture and prevents sweating during use.
- ▶ Slightly textured fingers and palm guarantees excellent grip and handling option both for dry, wet and oily products.

catalogue number	size	length	thickness	internal finish	external finish	pack quantity
080.23.007	7	310 mm	0,55 mm	flocked	embossed	1 pair
080.23.008	8	310 mm	0,55 mm	flocked	embossed	1 pair
080.23.009	9	310 mm	0,55 mm	flocked	embossed	1 pair



GLOVES - "for thermal resistance"

- ▶ Manufactured from nitrile foam. Suitable for handling hot objects up to 125°C. Also ideal for handling of materials after heat.
- ▶ Classified as CE category II they can be used both at laboratories and industry.
- ▶ Thin anatomical shape ensures dexterity. Offers excellent fit to the hands.
- ▶ Nitrile spheres at the palm and finger parts guarantees perfect insulation with excellent grip option.

catalogue number	size	length	internal finish	external finish	pack quantity
080.26.007	7	280 mm	flocked	dotted	1 pair
080.26.009	8	280 mm	flocked	dotted	1 pair
080.26.010	9	280 mm	flocked	dotted	1 pair



GLOVES - "silicone"

- Manufactured from best quality natural silicone resistant both to heat and cold.
- Guarantees excellent chemical and temperature resistance between -60°C to $+170^{\circ}\text{C}$.
- Very flexible and slip-proof characteristics guarantee easy and safe grip of all kinds of flasks and vessels

catalogue number	glove type	pack quantity
080.18.001	for 5 fingers	1 piece
080.18.002	full hand	1 piece



HEAT PROTECTOR

- Manufactured from natural silicone for protecting fingers. Resistant both to heat and cold.
- Offers excellent chemical and temperature resistance between -60°C to $+170^{\circ}\text{C}$.

- They offer a practical and economical alternative to gloves.
- Very flexible and slip-proof characteristics guarantee easy and safe grip of all kinds of flasks and vessels.

catalogue number	glove type	pack quantity
080.17.001	for 2 fingers	1 piece



HEAT PROTECTOR

- Manufactured from natural silicone for protecting hands. Resistant both to heat and cold.
- Offers excellent chemical and temperature resistance between -60°C to $+170^{\circ}\text{C}$.

- They offer a practical and economical alternative to gloves.
- Very flexible and slip-proof characteristics guarantee easy and safe grip of all kinds of flasks and vessels.

catalogue number	glove type	pack quantity
080.17.002	for 5 fingers	1 piece

DISPENSER BOX - "for nitrile glove boxes"

- Manufactured from crystal clear acrylic with excellent field of vision for storing and dispensing nitrile glove boxes.
- Perfect tools for storing and easy dispensing 4 different sizes gloves simultaneously.
- 4 compartments with easy inserts perfectly fit to the outer dimensions of the extra thick glove boxes and holds them stable at their positions.
- Designed for use either on desk top or wall mounted.

- Delivered with necessary attachment screws to be mount to the wall.

➤ Alternative 2 box size:

- box for standard gloves
- box for thick gloves

- Box for standard gloves can also accommodate the cleaning tissue box **catalogue number 080.65.002**.

catalogue number	dimensions	for gloves	pack quantity
080.05.001	215 x 70 x 465 mm	standard	1 piece
080.05.002	260 x 85 x 525 mm	thick	1 piece





VISITORS GOWN

- Shirt collar design visitors gown without hood and without pockets. Closure is provided with snap fasteners.
- Featured with rubber fasteners at wrist. For single use. Manufactured for visitors protection at laboratories.
- Slightly porous texture of the textile guarantees air permeability and prevents sweating during use.
- Light weight. Easy to wear. Soft and flexible texture offers full comfort during use. Universal cut for fitting all body sizes.

catalogue number
080.50.001

pack quantity
1 piece

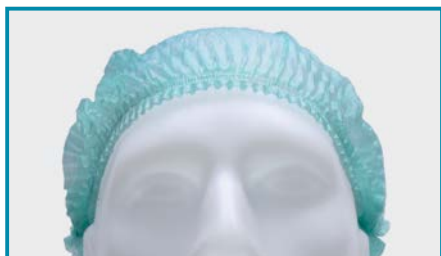

CAPS

- Manufactured from breathable, antistatic non-woven fabric. Fully protects hair from dust and other particles.

catalogue number
080.53.001

pack quantity
100 pieces



PROTECTOR SUIT

- Overall design protective suit with hood and without pockets. Closure is provided by zipper. Featured with rubber fasteners at wrist.
- For single use. Manufactured for employees and visitors protection at laboratories.
- Slightly porous texture of the textile guarantees air permeability and prevents sweating during use.
- Light weight. Easy to wear. Soft and flexible texture offers full comfort.

catalogue number
080.50.011

pack quantity
1 piece



OVER SHOES

- Manufactured from polyethylene for disposable use. Guarantees clean and sterile environment once worn on the shoes.

catalogue number
080.53.021

pack quantity
100 pieces



PROTECTOR SUITS - 5/6

- Manufactured from high density antistatic polyethylene, providing an ideal balance of protection, durability and comfort.
- Offers chemical protection according to category III (type 5 & 6). Also offers an excellent barrier against fine particles down to 1 micron size.
- Protective suit with overall design perfectly suitable for clean room areas.
- Also practical use at pharmaceutical handling and many others.

➤ Guarantees air permeability and prevents sweating during use. Repels water based liquids and aerosols.

➤ Optimised body fit provides excellent wearer comfort. Featured with hood compatible with filtering face masks.

➤ Featured with rubber fasteners at wrist and around face.

➤ Closure is provided by auto-lock zipper with flap for increased protection.

➤ Light weight. Easy to wear. Flexible texture offers full comfort during use.

catalogue number	size	pack quantity
080.51.003	Medium	1 piece
080.51.004	Large	1 piece
080.51.005	X Large	1 piece
080.51.006	XX Large	1 piece



DESK PROTECTOR - "paper"

➤ A practical desk protector offering full protection of desks against spilled solutions. Quickly absorbs liquids and keep spills from spreading. Absorbs up to 750 ml/m². Their thick protective layer eliminates the risk of glass breakage in case tilt over.

➤ **Thick and very absorbent paper layer soaks the spilled liquids and protects the laboratory desks.**

➤ **Consists of 2 layers:**

➤ **Flexible, water-proof polyethylene layer prevents the spilled liquid penetration to the laboratory desk.**

➤ Supplied as a roll of 50 meters length with 46 cm width.

catalogue number	pack quantity
080.66.001	1 piece

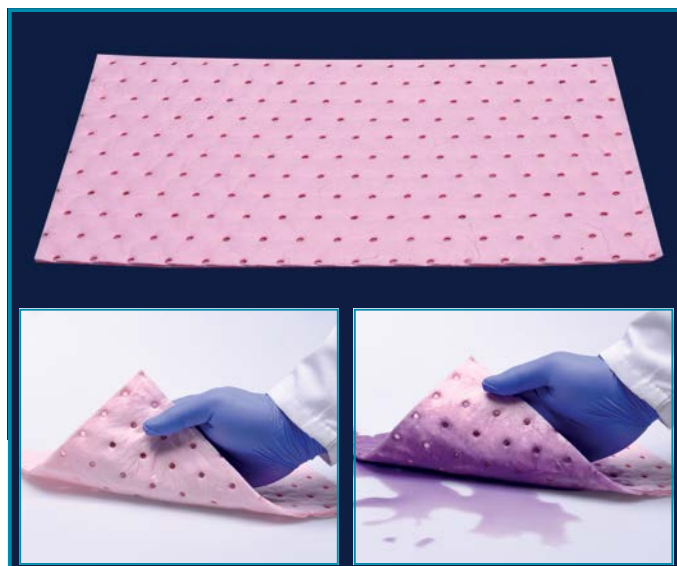

CHEMICAL PADS

➤ Due to their microfibre structure they provide excellent absorption capacity. Consists of 8 layer highly absorbant fibers which altogether "imprisons" the liquids and never returns back.

➤ Quickly absorbs the spills of all kinds of liquids including water based liquids, solvents, alcohols, acids and alkalis and stores them absorbed. The absorbed liquid can be extracted to be used again or to be disposed of separately.

catalogue number	pad sheet dimensions	thickness	pack quantity
080.76.001	50 x 40 cm	3,4 mm	10 pieces



DESK PROTECTORS - "cork"

➤ Manufactured from non-porous, additive free, best quality natural cork for protection of laboratory desks. Offers full protection against over heated flasks.

➤ Their thick protective layer eliminates the risk of glass breakage in case tilt over. Their light yet robust construction also significantly reduce vibration effects and noise.

catalogue number	dimensions	thickness	pack quantity
080.66.002	200 x 200 mm	10 mm	1 piece
080.66.003	300 x 300 mm	10 mm	1 piece

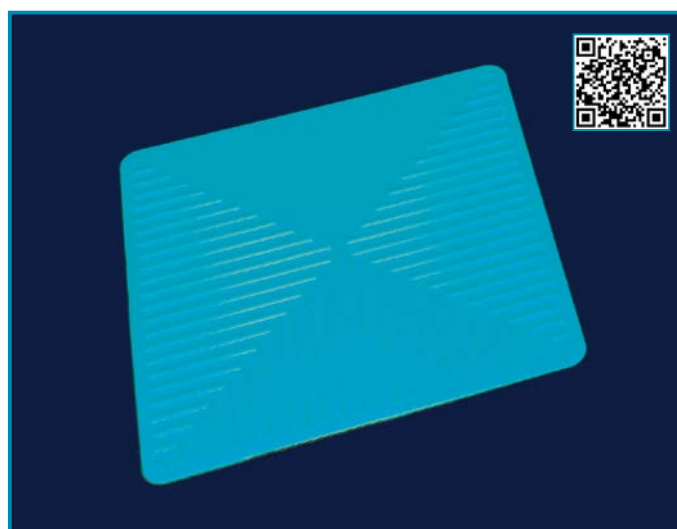

DESK PROTECTORS - "silicone"

➤ Manufactured from best quality natural silicone resistant both to heat and cold. Guarantees excellent chemical and temperature resistance between -60°C to +260°C.

➤ Very flexible and slip-proof characteristics guarantees safe hold of all flasks and also instruments. They offer full protection of desks against spilled solutions and over heated flasks.

catalogue number	dimensions	specification	pack quantity
080.66.005	240 x 240 mm	corrugated surface	1 piece
080.66.006	340 x 340 mm	corrugated surface	1 piece

cleaning & safety & protection & sterilization



DUST MASK - "FFP-1"

- Offers protection against non-toxic harmful solid and liquid in concentrations up to 4 x OEL or 4 x APF.
- Specially recommended for calcium carbonate, china clay, cement, cellulose, cotton, sulfur, ferrous metals and foods.
- Convex design, aluminium nosepiece and adjustable fitting straps guarantee excellent fit to different face shapes.
- Light weight provides strain and fatigue free use even with extended hours.
- Inner and external layers of the mask manufactured from soft microfiber.

catalogue
number
080.41.001

pack
quantity
1 piece



DUST MASK - "FFP-2"

- Offers protection against low-to-average toxic solids, liquids and smoke up to 12x OEL or 10 x APF.
- Addition to FFP-1 protection limits also offers protection against glass wool, mineral oils, most bacterias and fungi.
- Convex design, aluminium nosepiece and adjustable fitting straps guarantee excellent fit to different face shapes.
- Exhalation valve significantly minimise warm and humid airflow into the mask.
- Other technical properties are same with "FFP-1" dust mask.

catalogue
number
080.41.002

pack
quantity
1 piece



DUST MASK - "FFP-3"

- Offers protection against highly toxic solids, liquids and smoke up to 50 x OEL or 20 x APF.
- Addition to FFP-2 protection limits also offers protection against heavy metal particles, smokes and odores and viruses.
- Convex design, aluminium nosepiece and adjustable fitting straps guarantee excellent fit to different face shapes.
- Exhalation valve significantly minimise warm and humid airflow into the mask.
- Other technical properties are same with "FFP-2" dust mask.

catalogue
number
080.41.003

pack
quantity
1 piece



MASK - "half face"

- Designed and manufactured according to DIN EN 140 and EN 14387 standards for protection of mouth and nose.
- All parts contacting with the face are manufactured from silicone.
- Cool flow valve prevents built-up heat in the mask.
- Soft silicone facepiece perfectly fits to the contours of the face without pressure points providing full comfort.
- Filter system with exchangeable cartridge filter ensures low breathing resistance.
- Supplied with a multiple gas cartridge for protection from dust, fine particles, mist, smoke, organic vapours and gases with boiling point 65°C or above.

catalogue number	product descriptions	pack quantity
080.44.001	half face mask	1 piece
080.44.101	spare gas cartridge	1 piece



MASK - "full face"

- Designed and manufactured according to EN 136:1998 for protection of full face.
- Featured with anti-stretch, anti-fogging, distortion-free polycarbonate shield.
- Cool flow valve prevents built-up heat in the mask.
- Soft silicone facepiece perfectly fits to the contours of the face without pressure points providing full comfort.
- Filter system with exchangeable cartridge filter ensures low breathing resistance.
- Supplied with a multiple gas cartridge for protection from dust, fine particles, mist, toxic smoke organic or inorganic vapours and gases with boiling point 65°C or above, sulfur dioxide, acidic gasses and ammonia gas.

catalogue number	product descriptions	pack quantity
080.45.001	full face mask	1 piece
080.45.101	spare gas cartridge	1 piece



*density & sedimentation
temperature & time
pH & weight measurement*

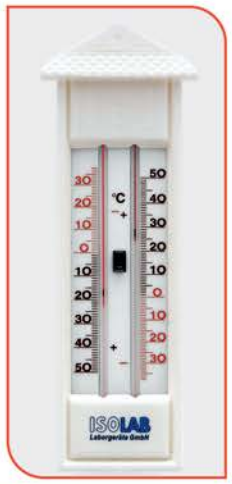

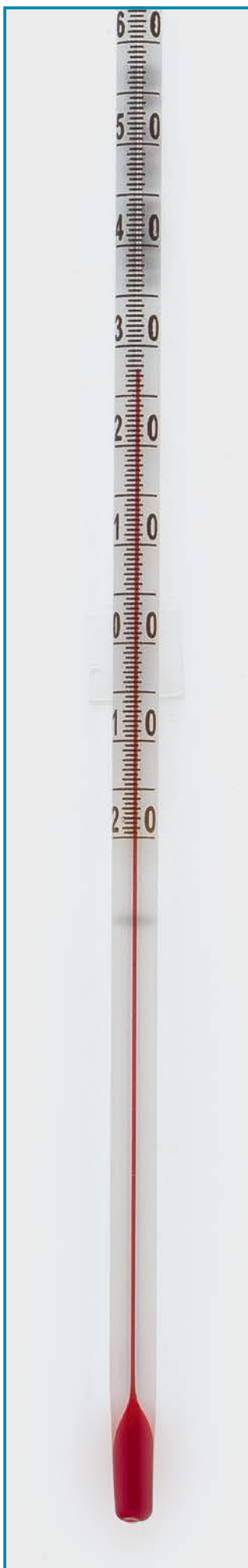

THERMOMETERS - "glass"

- Manufactured from solid stem glass rods with approximately 75 mm immersion depth.
- Printed large graduation on the front wall offers easy temperature reading.
- Large alcohol column with red color enables easy and accurate readout.
- The amber front scale of the thermometer reflects the images more clearly.

catalogue number	operation range °C	subdivision	pack quantity
059.02.001	-20/+50	1°C	10 pieces
059.02.002	-20/+110	1°C	10 pieces
059.02.003	-10/+150	1°C	10 pieces
059.02.004	-10/+200	2°C	10 pieces

THERMOMETER CLAMP "with bosshead"

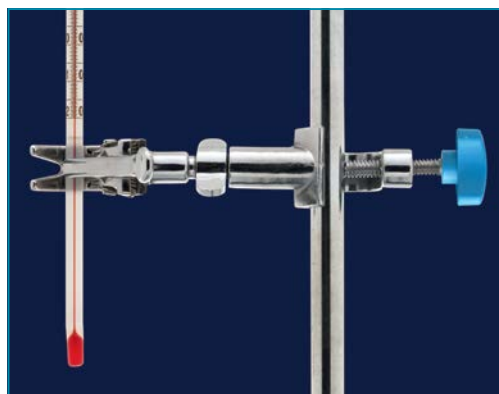

- Manufactured from high quality, corrosion resistant chromated steel for holding thermometers in the most secure way.
- Featured with a swivel bosshead which provides 360° swivel of the clamped object around their axis.
- Bosshead locking feature guarantees perfect position hold of the clamped objects.
- Fixing head featured with flexible springs offers easy insertion and extraction of the thermometers.
- Clamps can be opened and closed smoothly with a 30 mm grip diameter.

Other technical specifications can be seen at catalogue page no 51.

STAND "adjustable height"

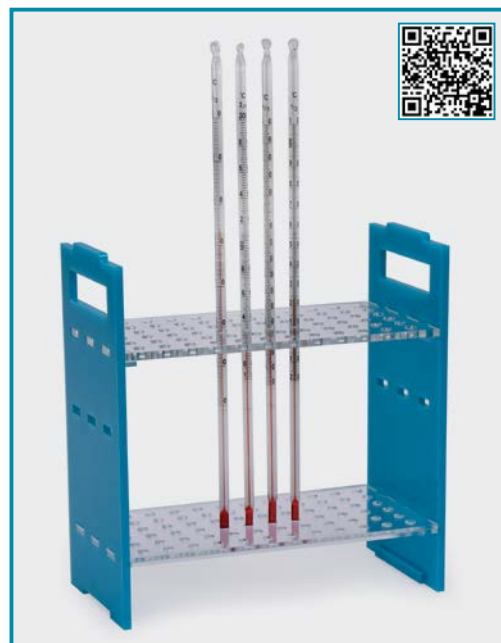

- Manufactured from acrylic for holding 72 thermometers in 12 x 6 array.

- Handles at both sides guarantee easy hold and secure grip.

- Adjustable height upper layer provides multi-use options with shorter objects.

catalogue number	dimensions	pack quantity
059.05.001	210 x 110 x 220 mm	1 piece



Adjustable height upper layer provides multi use options with shorter objects.

density & sedimentation & temperature & time & pH & weight measurement



THERMOMETER
"portable"

- For temperature measurement in liquids, semi-solids. Specially offers practical solutions with foodstuff.
- Stainless steel probe with 127 mm length can easily be inserted into semi-solid samples.
- Offers temperature measurement on a large and clear 19 x 8 mm LCD display.
- Water resistant sturdy plastic housing offers long life cycle.
- Temperature measurement range is -58°F to +158°F (+/- 0,2°F) or -50°C to +300°C (+/- 0,1°C) selectively.
- °F & °C values are exchangeable by a switch control at the front panel.
- Supplied with a plastic sleeve for the protection of the measuring probe.

catalogue
number

060.01.001

pack
quantity

1 piece



THERMOMETER
"portable"

- For temperature measurement in liquids, semi-solids. Specially offers practical solutions with foodstuff.
- Stainless steel probe with 120 mm length can easily be inserted into semi-solid samples.
- Offers temperature measurement on a large and clear 34x14 mm LCD display.
- Water resistant sturdy plastic housing offers long life cycle.
- Temperature measurement range is -58°F to +572°F (+/- 2°F) or -50°C to +300°C (+/- 0,5°C) selectively.
- °F & °C values are exchangeable by a switch control at the front panel.
- Supplied with a plastic sleeve for the protection of the measuring probe.

catalogue
number

060.01.002

pack
quantity

1 piece



THERMOHYGROMETER
"portable"

- Pen shape, thermohygrometer is featured with a rotary probe enabling fast readings.
- Water resistant sturdy plastic housing with 138 mm length offers long life cycle.
- Featured with a clips for safe and practical use.
- Offers dual display for humidity and temperature on a large and clear 52 x 13 mm LCD display.
- Featured with maximum & minimum reading memory.
- Humidity measurement range is 20% RH – 95 %RH with +/- 3%RH accuracy.
- Temperature measurement range is 32 - 122°F (+/- 2°F) or 0 - 50°C (+/- 1°C) selectively.
- °F & °C values are exchangeable by a simple switch control at the back.

catalogue
number

060.03.002

pack
quantity

1 piece



THERMOMETER - "desk-top"

- This desk top electronic thermometer can be also used as wall hanged. With the help of two probes can be used for indoor and out-door temperature measurement simultaneously.
- The folding stand at the back housing offers a convenient angle for easy reading of the results.
- Water resistant sturdy plastic housing with 135 x 75 x 19 mm dimensions offers long life cycle.
- Offers dual display for humidity and temperature on a large and clear 51 x 41 mm LCD display.
- Featured with maximum & minimum temperature reading memory with an alarm function and date / time display.
- Temperature measurement range is -4°F to +122°F (+/- 0,2°F) or -20°C to +50°C (+/- 0,1°C) selectively.
- °F & °C values are exchangeable by a switch control at the front panel.

catalogue number	pack quantity
060.02.001	1 piece



THERMOHYGROMETER - "desk-top"

- This desk top thermohygrometer can be also used as wall hanged. The folding stand at the back housing offers a convenient angle for easy reading of the results.
- Water resistant sturdy plastic housing with 109 x 70 x 19 mm dimensions offers long life cycle.
- Offers dual display for humidity and temperature on a large and clear 40 x 30 mm LCD display.
- Featured with maximum & minimum temperature reading memory with an alarm function.
- Humidity measurement range is 10% RH – 99 %RH with +/- 5%RH accuracy.
- Temperature measurement range is -58°F to +158°F (+/- 0,2°F) or -50°C to +70°C (+/- 0,1°C) selectively.
- °F & °C values are exchangeable by a switch control at the front panel.

catalogue number	pack quantity
060.03.001	1 piece



THERMOMETER - "with foldable probe"

- For temperature measurement in liquids, semi-solids. Specially offers practical solutions with foodstuff.
- Featured with a foldable stainless steel probe with 85 mm length which can move 180° angle. Probe can easily be inserted into semi-solid samples.
- Offers temperature measurement on a large and clear 15 x 30 mm LCD display.
- Temperature measurement range is -58°F to +482°F or -50°C to +250°C with +/- 0,1 resolution.
- °F & °C values are exchangeable by a switch control inside the battery cover.
- Water resistant sturdy plastic housing offers long life cycle.

catalogue number	pack quantity
060.01.003	1 piece



THERMOMETER - "wireless" - "max. & min."

- This thermometer is suitable both for out-door or in-door applications. Shows also time and date simultaneously.
- Maximum and minimum temperature values can also be seen by a selectable switch.
- Featured with a wireless measurement transmitter that can be used up to 60 meters (free field) to the thermometer body.
- Can display in-door and out-door temperature. °F & °C values are selectable by a switch at the front panel.
- Offers a in-door temperature measuring range from -10°C (+ 14°F) to +60°C (+140°F) with a precision of +/- 1°C (+/- 2°F)
- Offers a out-door temperature measuring range from -40°C (-58°F) to +70°C (+158°F) with a precision of +/- 1°C (+/- 2°F)
- Featured with a push buttons switches for resetting, °C or °F selection, maximum or minimum reading setting.

catalogue number	pack quantity
059.03.003	1 piece

Featured with a wireless measurement transmitter that can be used up to 60 meters (free field) to the thermometer body.



THERMOMETER - "max. & min." - "humidity"

- Suitable both for out-door or in-door applications. Weather resistant, robust housing is featured with an inclined shelter for further protection.
- Can measure and display in-door temperature and humidity plus out-door temperature.

Offers 3 parameters

- In-door temperature
- Out-door temperature
- %RH humidity

- Can also records and shows the maximum and minimum values of temperature and humidity selectively.
- Offers a in-door temperature measuring range from -10°C (+14°F) to +50°C (+122°F) with a precision of +/- 1°C (+/- 2°F)
- Offers a out-door temperature measuring range from -50°C (-58°F) to +70°C (+ 158°F) with a precision of +/- 1°C (+/- 2°F)
- Offers a in-door humidity measuring range from 20% RH to 99% RH with a precision of +/- 5% RH.
- Featured with push buttons switches for °C or °F selection and maximum or minimum temperature.
- Can be hanged on walls or can stand on a bench.

catalogue number	pack quantity
059.03.004	1 piece



**STOPWATCH - "mechanical"**

- This classical stopwatch with mechanical winding system can be used even in extreme conditions.
- Provides time counting up to 30 minutes with 0,2 second resolution.
- Chrome plated sturdy housing provides resistance to sudden impacts and guarantees long life cycle.

**STOPWATCH - "electronic"**

- Electronic stopwatch offers counting up to 59 minutes, 59 seconds with 0,01 second resolution.
- Offers long life cycle and easy use with it's water resistant sturdy plastic housing and light weight.
- **3 functions:**
 - As a time recorder
 - As a chronometer
 - As a 24 hour timer with alarm function.

**TIMER - "mechanical"**

- Mechanical timer counts up to 60 minutes with 1 minute resolution.
- No need for batteries. Just winding will be enough to start the time counting.
- A clear bell ring signals at the end of the preset time. Can be interrupted during work and reset any time.
- Can be used on bench top or also can be hanged to any smooth surface.

catalogue number	diameter	pack quantity
055.01.001	50 mm	1 piece

catalogue number	dimensions	pack quantity
055.02.001	63 x 76 x 20 mm	1 piece

catalogue number	dimensions	pack quantity
056.01.001	60 x 60 x 34 mm	1 piece

**TIMER - "mechanical"**

- Mechanical timer counts up to 60 minutes with 1 minute resolution. Does not require batteries. Just winding will be enough to start the counting.
- A clear bell ring signals at the end of the preset time. Can be interrupted during work and reset any time.

catalogue number	dimensions	pack quantity
055.03.001	93 x 75 x 59 mm	1 piece

**TIMER - "mechanical"**

- Mechanical timer counts up to 60 minutes with 1 minute resolution. A large screen with 150 mm diameter provides easy reading option from relatively long distances.
- Featured with a red marked area for remaining time for long distance observation.
- Can be used on bench top or also can be hanged to any smooth surface.

catalogue number	pack quantity
055.04.001	1 piece



TIMER - "electronic"

- Electronic timer counts up to 19 hours, 59 minutes with a 4 digit display for extended hours. Also featured with count-down function.
- A clear bell ring signals at the end of the preset time.
- A large LCD screen with 32 x 12 mm dimensions provides easy reading option from relatively long distances.
- The folding stand at the back housing offers a convenient angle for easy reading. Also featured with a clip at the back side.

catalogue number	timer dimensions	screen dimensions	pack quantity
056.03.001	53 x 62 x 12 mm	32 x 12 mm	1 piece



TIMER - "electronic"

- Electronic timer counts up to 59 minutes, 59 seconds with a 4 digit display. Also featured with count-down function.
- A clear bell ring signals at the end of the preset time.
- A large LCD screen with 50 x 26 mm dimensions provides easy reading option from relatively long distances.
- The folding stand at the back housing offers a convenient angle for easy reading of the results. A clip at the back side of the watch enables easy wall mounting.

catalogue number	timer dimensions	screen dimensions	pack quantity
056.02.001	69 x 69 x 15 mm	50 x 26 mm	1 piece



TIMER - "electronic"

- Electronic timer counts down with selected intervals of 10 seconds / 1 minute / 5 minute and 10 minute.
- A clear visual and audial signal flashes at the end of the selected time.
- LCD screen with 30 x 80 mm dimensions provides easy reading option from relatively long distances.
- The folding stand at the back housing offers a convenient angle for easy reading.
- A clip at the back side of the watch enables easy wall mounting. Can be hung on metal surfaces with the two magnets provided at the back.

catalogue number	timer dimensions	screen dimensions	pack quantity
056.04.001	70 x 90 mm	30 x 80 mm	1 piece

density & sedimentation & temperature & time & pH & weight measurement

METER - "portable" - "pH & mV & temperature measurement"



- Offers an economical solution for measuring pH & mV and temperature. Simple to calibrate by one keyboard.
- Easy to replace electrode. The new electrode will be recognised automatically and shown at the display.
- Ergonomic, lightweight and waterproof (which can even float on water) housing enables perfect outdoor practice.
- Measured values are shown by a microprocessor based large LCD display.
- Stores maximum and minimum measured values in memory.
- Offers a switchable temperature selection of °C or °F.
- Featured with a low battery and energy consumption indicator.
- Automatic switch-off function closes the circuit after 10 minutes of non use.
- Supplied in a carrying case, with instruction manual and calibration standard set.

Meters are supplied in a sturdy carry case complete with hand held stripe, pH buffer solutions, cleaning solution, instruction manual and other standard accessories.



catalogue no: 616.01.001	pH	mV	Temp
<i>range</i>	-2.00 / 16.00 pH	-1000 / 1000	0 / 90°C
<i>accuracy</i>	± 0.01+1 digit	± 2 + 1 digit	±1 + 1 digit
<i>resolution</i>	0.01 pH	1 mv	0.1°C
<i>compensation</i>	0 / 90°C		

METER - "portable" - "pH & mV & temperature & conductivity & TDS & salt measurement"



- Offers an economical solution for measuring pH & mV & temperature. & conductivity & TDS & salt with one single electrode.
- Ergonomic, lightweight and waterproof (which can even float on water) housing enables perfect outdoor practice.
- Simple to calibrate by one keyboard.
- Memory function stores and recalls different measurements.
- Microprocessor based large LCD displays show the measured values and the temperature simultaneously.

- Featured with automatic temperature compensation (ATC) . Offers a switchable temperature selection of °C or °F.
- Easy to replace electrode. The new electrode will be recognised automatically and shown at the display.
- Featured with a low battery and energy consumption indicator.
- Automatic switch-off function closes the circuit after 10 minutes of non use.
- Supplied in a carrying case, with instruction manual and calibration standard set.



Meters are supplied in a sturdy carry case complete with hand held stripe, pH buffer solutions, cleaning solution, instruction manual and other standard accessories.

catalogue no: 616.02.002	pH	mV	Temp	Conductivity	TDS	Salt
<i>range</i>	-2.00 / 16.00 pH	-1999 / 2000	0 / 110°C	0 / 199.9 µs 2.00 / 100.00 ms	0 / 131.9 ppm 1.30 / 13.19 ppt	0 / 99.9 ppm 10 / 50.00 ppt
<i>accuracy</i>	± 0.01+1 digit	± 2 + 1 digit	±0,2 + 1 digit	± 2 % FS		
<i>resolution</i>	0.01 pH	0,1 / 1 mv	0.1°C	0.1 µS / 0.01 mS	1 ppm / 0.01 ppt	
<i>compensation</i>	0 / 100°C			0 / 50°C		

density & sedimentation & temperature & time & pH & weight measurement

METERS - "table top"

- Featured with microprocessor based design and rugged housing with splash proof keyboard.
- Microprocessor based large LCD display enables fast and accurate measurements.
- Automatic calibration enables fast measuring cycles.
- Easy replacement of electrode and the type of the electrode would be recognised automatically and shown on the display during insertion.
- Can measure and display (depending on model) pH & mV & temperature & conductivity & TDS & salt & dissolved oxygen in seconds.
- The large backlight LCD displays pH or mV or conductivity or TDS or salt or dissolved oxygen and temperature simultaneously.
- Offers a switchable temperature selection of °C or °F.
- Featured with an automatic temperature compensation (ATC).
- Stores maximum and minimum measured values in memory. Memory function can keep and recall up to 150 data.



Table top meters have a special platform with a magnetic stirrer which enables fast and accurate measurements and results.

Membrane keypad with large backlight LCD displays pH or mV or conductivity or TDS or salt or dissolved oxygen and temperature simultaneously.

catalogue no: 616.11.001

	pH	ORP	Temp
range	-2.00/ 16.00 pH	-1999/ -200 mV -199.9/ 499.9 mV 500/ 2000 mV	0/ 110°C
accuracy	± 0.01+1 digit	± 2 + 1 digit	±0.2+1 digit
resolution	0.01 pH	0.1/ 1 mv	0.1°C
compensation	ATC: 0/ 100°C	N/A	

catalogue no: 616.12.001

	pH	mV	Temp	Conductivity	TDS	Salt	DO	O2
range	-2.00/ 16.00 pH	-1999/ -200 mV -199.9/ 499.9 mV 500/ 2000 mV	0/ 110°C	0.0/ 199.9 µS 200/ 1999 µS 2.00/ 19.99 mS 20.0/ 100.0 mS	0.0/ 131.9 ppm 132/ 1319 ppm 1.32/ 13.19 ppt 13.2/ 66.0 ppt	0.0/ 99.9 ppm 100/ 999 ppm 1.00/ 9.99 ppt 10.0/ 50.0 ppt	0/ 20.00 mg/L 0/ 20.00 ppm	0/ 200.0 %
accuracy	± 0.01+1 digit	± 2 + 1 digit	±1+1 digit	± 2 % FS			± 0.2 + 1 digit	± 2 % FS
resolution	0.01 pH	0.1/ 1 mv	0.1°C	0.1µS/ 0.1mS	0.1 ppm/ 0.1 ppt	0.1 ppm/ 0.1 ppt	0.01 mg/ L	0.10%
compensation	ATC: 0/ 100°C	N/A		ATC: 0/ 60°C			ATC: 0/ 60°C MSC: 0/ 50 ppt MAC: 0/ 20000 ft	

ACCESORIES - "for pH meters"



Soaking solution - 50 ml
Catalog No: 616.01.101



DO solution - 50 ml
Catalog No: 616.11.107



Conductivity solution - 120 ml
Catalog No: 616.11.101



Conductivity solution - 120 ml
Catalog No: 616.11.102

for 616.01.001



pH electrode
Catalog No: 616.01.103

for 616.01.001



ORP electrode
Catalog No: 616.01.104

for 616.02.002



pH electrode
Catalog No: 616.02.101

for 616.02.002



ORP electrode
Catalog No: 616.02.102

for 616.11.001 & 616.12.001



pH electrode
Catalog No: 616.11.103

for 616.12.001



Conductivity electrode
Catalog No: 616.11.104

for 616.12.001



DO probe
Catalog No: 616.11.105

for 616.11.001 & 616.12.001



Temperature probe
Catalog No: 616.11.108

pH BUFFER SOLUTIONS

➤ Ready to use pH buffer solutions with color coding, accuracy +/- 0,01 pH at 20°C. Traceable to NIST, packed in unique designed, practical twin-neck dosing bottles!

➤ Unique and innovative design of the "twin neck" dosing bottles offers multiple advantages:

➤ No need for a separate measuring container during calibration.

➤ No waste of buffer since exact and correct quantity of buffer is dispensed into the calibrating chamber at all times.

➤ Ideally suited for field work and easy to carry.

Operation is simple, fast and easy;

➤ Open safety lock of the integrated calibration chamber.

➤ Fill calibration chamber from buffer reservoir by pressing the bottle gently.

➤ Calibrate pH electrode then discard used buffer solution. Bottle is now ready for the following use.

catalogue number	pH range	color	volume	pack quantity
502.04.500	4.00	red	500 ml	1 piece
502.04.901	4.00	red	1000 ml	1 piece
502.07.500	7.00	yellow	500 ml	1 piece
502.07.901	7.00	yellow	1000 ml	1 piece
502.10.500	10.00	blue	500 ml	1 piece
502.10.901	10.00	blue	1000 ml	1 piece



pH BUFFER SOLUTIONS

➤ Ready to use pH buffer solutions at 20°C.

➤ Measured with a combination glass electrode after multiple point calibration with reference materials.

➤ It is certified traceable to the following National Institute of Standards and Technology (USA).



catalogue number	pH range	technical specifications	volume (ml)	box quantity
908.B01.1000	1.00 ± 0.02	(hydrochloric acid, potassium chloride)	1000	1 piece
908.B02.1000	2.00 ± 0.02	(glycine, hydrochloric acid, sodium chloride)	1000	1 piece
908.B03.1000	3.00 ± 0.02	(potassium hydrogen phthalate, hydrochloric acid)	1000	1 piece
908.B04.1000	4.00 ± 0.01	(potassium hydrogen phthalate)	1000	1 piece
908.B05.1000	5.00 ± 0.01	(potassium hydrogen phthalate, 1m sodium hydroxide.)	1000	1 piece
908.B06.1000	6.00 ± 0.01	(potassium di-hydrogen orthophosphate, disodium hydrogen orthophosphate)	1000	1 piece
908.B07.1000	7.00 ± 0.01	(potassium di-hydrogen phosphate, disodium hydrogen phosphate)	1000	1 piece
908.B08.1000	8.00 ± 0.01	(di-sodium tetraborate, 1m hydrochloric acid)	1000	1 piece
908.B09.1000	9.00 ± 0.01	(di-sodium tetraborate, 1m hydrochloric acid.)	1000	1 piece
908.B10.1000	10.00 ± 0.01	(di-sodium tetraborate, 1m sodium hydroxide)	1000	1 piece
908.B11.1000	11.00 ± 0.05	(glycine, sodium chloride, sodium hydroxide)	1000	1 piece



LITHMUS PAPERS - "red & blue"

- Litmus papers are the simplest and easiest way to measure pH values where no precise pH value is required. They are useful for determining whether a solution is acidic or basic.
- The red litmus paper has a pH measurement range 5,0 pH to 8,0 pH. The color changes from **red** → **blue**
- The blue litmus paper has a pH measurement range 8,0 pH to 5,0 pH. The color changes from **blue** → **red**
- Packed as a booklet of 20 papers. 10 booklets are packed in a polystyrene box for for easy dispensing.

catalogue number	paper type	pack quantity
101.01.001	red	10 booklets
101.01.002	blue	10 booklets



pH PAPER - "universal" - "roll"

- Most commonly used pH papers for a wide field of application of pH measurement. They can measure pH values between 1,0 pH to 14,0 pH with 1 pH intervals.
- They provide easy pH measurement of solutions by using single color change.
- After the measurement, the pH value can be found by matching the color on the paper with the reference color chart printed at the back side of the box.
- Supplied in a box roll of 6 mm width and 5 meters length.

catalogue number	pack quantity
101.02.002	1 box



pH INDICATOR STRIPS

- They provide precise pH measurement of solutions by using single color change.
- pH measurement pads with different colors are chemically bounded to a cellulose fiber stick.
- This effectively protects the sample against contamination and enables measurements even in weakly buffered or strongly alkaline solutions.
- Fingers are protected from the test solution since the test pads are located at the extreme end of the strips.
- Since the pads do not bleed, pad colors do not interfere and mix with each other after the test and ensures reliable pH measurement.
- After the measurement, the pH value can be found by matching the colors on the pads with the reference color chart printed at the back side of the box.
- 100 pieces strip is packed in a clear polystyrene box for hygienic storage and for easy dispensing.

Isolab brand	M. Nagel brand	pH measuring range	pH graduation	strip width	strip length	pack quantity	box quantity
101.02.001	101.02.003	0,0 - 14,0 pH	1,0 pH	6 mm	80 mm	100 strips	1000 strips

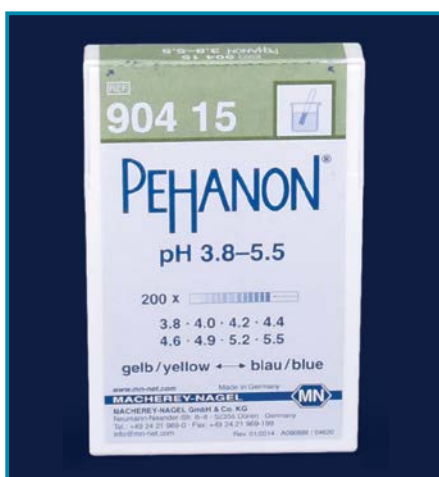

TEST STRIPS - "PEHANON"

- Test strip for pH measurement which unifies the pH-indicator with the reference pH color chart on the same strip.
- pH values can be determined without a separate color chart. They provide precise pH measurement of solutions by using single color change.
- The user can be sure to get accurate pH values at all times.
- Fast measurement results are guaranteed since they do not require an addition step of matching the pad color with a reference color scale.
- The handle will remain dry and clean by the invisible hydrophobic barrier.
- 200 pieces strip is packed in a clear polystyrene box for hygienic storage and for easy dispensing.

Isolab brand	M. Nagel brand	pH measuring range	pH graduation	strip width	strip length	pack quantity	box quantity
101.14.003	101.04.003	3,8 - 5,5 pH	0,2/0,3 pH	6 mm	80 mm	200 strips	2000 strips

QUANTOFIX TEST STRIPS - "peroxide"

- A very special "ready-to-use" test strip with semi-quantitative nature for various measurements.
- Can be considered as ready to use kits that give precise results 10 - 120 seconds after use. Precise graduations guarantees reliable test results.
- The color chart is adjusted by certified standard solutions which are directly traceable to NIST standards.
- For reliable test results and longevity of the strip closing the cap after removing the strip is recommended.
- The desiccant in the stopper also effectively protects the strip against moisture.
- 100 pieces strip are packed in a box for hygienic storage and for easy dispensing.

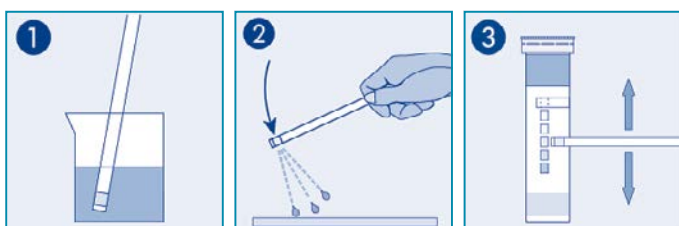

Dip the test strip in sample as far as the arrow indicates. Shake off excess liquid and place the strip on a horizontal surface. Read the result by comparing the test field with the color scale for one second.



Isolab brand	M. Nagel brand	product name	product type	graduation	strip width	strip length	pack quantity	box quantity
101.13.003	101.03.003	QUANTOFIX	PEROXIDO 100	0 - 1 - 3 - 10 - 30 - 100 mg/L H ₂ O ₂	6 mm	95 mm	100 strips	1000 strips

TEST STRIPS - "for water hardness"

- In dialysis hard water can damage the delicate osmosis units.
- For this reason accurate and quick testing of water hardness is very important
- "Diaquant" test strips are specially designed for reliable and accurate low-range water hardness tests of rinse and feed water specially at dialysis environment.
- All water hardness tests are done simple and fast without any mixing.
- The easy dip & read procedure provides a reliable result in 10 seconds.
- After the test color changes from white to pink.
- Packed in a box of 50 strips of 6 mm width and 95 mm length.

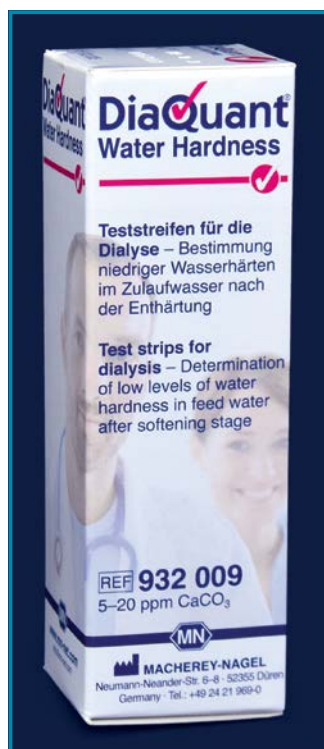

Isolab brand	M. Nagel brand	graduation	pack quantity
101.13.005	101.03.005	0 - 5 - 10 - 20 ppm CaCO ₃	50 pieces

AQUADUR TEST STRIPS

- A special "ready-to-use" test strip for determination of water hardness.
- Clear color changes from green to red guarantees reliable test results.
- Can precisely determine water hardness in a liquid very precisely from very soft water to very hard water.
- Since the color change is very clear and sharp with green / red indication they do not require any reference color scale for matching.
- The hardness of the water depends on its content of calcium and magnesium salts and expressed in terms of ppm (mg/l) CaCO₃.
- Packed in a box of 100 strips of 6 mm width and 95 mm length.



Isolab brand	M. Nagel brand	graduation	pack quantity
101.13.004	101.03.004	<3->5->10->15->20->25°d	100 strips



BALANCE
"0,0001 gr precision"

- Reliable weighing with 0,0001 gr precision with single cell weighing system.
- Microprocessor controlled weighing technology guarantees fast and precise results at any time.
- Equipped with internal fully automatic calibration for quick setting of the balance.
- Featured with easy-to-read, large, backlite LCD display with advanced eye protection.
- State-of-art touch button screen with optimised keypad response immediately.
- Robust housing protects internal components from environmental effects.
- Equipped with internal re-chargeable battery. Supplied with a dust cover.

catalogue no	602.31.001
weighing range (g)	220
readability (g)	0,0001
reproducibility (mg)	± 0,1
linearity (mg)	± 0,2
pan diameter (mm)	90
weighing units	mg, g, kg, lb, oz, ozt, gn, ct
calibration	internal, fully automatic
display	LCD
cabin type	full
dimensions (mm)	342 x 212 x 341



BALANCE
"0,001 gr precision"

- Reliable weighing with 0,001 gr precision with single cell weighing system.
- Microprocessor controlled weighing technology guarantees fast and precise results at any time.
- Equipped with external weight calibration system for quick setting.
- Featured with easy-to-read, large, backlite LCD display with advanced eye protection.
- State-of-art touch button screen with optimised keypad response immediately.
- Robust housing protects internal components from environmental effects.
- Equipped with internal re-chargeable battery. Supplied with a dust cover.

catalogue no	602.31.002
weighing range (g)	320
readability (g)	0,001
reproducibility (mg)	± 2
linearity (mg)	± 3
pan diameter (mm)	85
weighing units	g, kg, lb, oz, ozt, gn, ct
calibration	external
display	LCD
cabin type	with windshield
dimensions (mm)	280x210x275



BALANCE
"0,01 gr precision"

- Reliable weighing with 0,01 gr precision with single cell weighing system.
- Microprocessor controlled weighing technology guarantees precise results.
- Equipped with external weight calibration system for quick setting.
- Featured with easy-to-read, large, backlite LCD display with advanced eye protection.
- State-of-art touch button screen with optimised keypad response immediately.
- Robust housing protects internal components from environmental effects.
- Equipped with internal rechargeable battery. Supplied with a dust cover.

catalogue no	602.31.003
weighing range (g)	1200
readability (g)	0,01
reproducibility (mg)	± 20
linearity (mg)	± 20
pan diameter (mm)	130
weighing units	g, kg, lb, oz, ozt, gn, ct
calibration	external
display	LCD
cabin type	with windshield
dimensions (mm)	280x210x180



BALANCE
"0,01 gr precision"

- Reliable weighing with 0,01 gr precision with single cell weighing system.
- Microprocessor controlled weighing technology guarantees precise results.
- Equipped with external weight calibration system for quick setting.
- Featured with easy-to-read, large, backlite LCD display with advanced eye protection.
- State-of-art touch button screen with optimised keypad response immediately.
- Robust housing protects internal components from environmental effects.
- Equipped with internal rechargeable battery. Supplied with a dust cover.



BALANCE
"0,01 gr precision"

- Reliable weighing with 0,1 gr precision with single cell weighing system.
- Microprocessor controlled weighing technology guarantees precise results.
- Equipped with external weight calibration system for quick setting.
- Featured with easy-to-read, large, backlite LCD display with advanced eye protection.
- State-of-art touch button screen with optimised keypad response immediately.
- Robust housing protects internal components from environmental effects.
- Equipped with internal rechargeable battery. Supplied with a dust cover.



BALANCE
"0,01 gr precision"

- Provides comfortable and reliable weighing with 0,01 gr precision.
- Fits even into a pocket. Occupies minimal space on the laboratory bench, yet maintains optimal performance. Ideal assistant where mobility and precision are required.
- Microprocessor controlled weighing technology guarantees precise results.
- Featured with easy-to-read, large, backlite LCD display with advanced eye protection.
- Robust housing protects internal components from environmental effects.
- Battery operated. With auto power off after 30 seconds for energy saving.



catalogue no	602.31.006
weighing range (g)	4200
readability (g)	0,01
reproducibility (mg)	± 20
linearity (mg)	± 40
pan size (mm)	185 x 160
weighing units	g, kg, lb, oz, ozt, gn, ct
calibration	external
display	LCD
cabin type	without windshield
dimensions (mm)	280x210x100 mm

catalogue no	602.31.007
weighing range (g)	6200
readability (g)	0,1
reproducibility (mg)	± 100
linearity (mg)	± 200
pan size (mm)	185 x 160
weighing units	g, kg, lb, oz, ozt, gn, ct
calibration	external
display	LCD
cabin type	without windshield
dimensions (mm)	280x210x100 mm

catalogue no	602.32.001
weighing range (g)	500
readability (g)	0,01
reproducibility (mg)	± 50
linearity (mg)	± 50
pan size (mm)	100 x 100
weighing units	g, oz, gn,
calibration	-----
display	LCD
cabin type	without windshield
dimensions (mm)	125x105x15 mm

density & sedimentation & temperature & time & pH & weight measurement

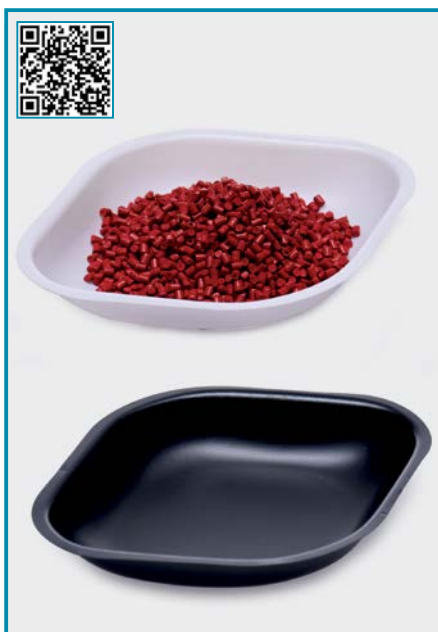

WEIGHING DISHES - "P.S"

- Manufactured from polystyrene for many applications such as weighing, dispensing and storing.
- Anti-static property of the raw material eliminates the static built-up. Specially recommended for weighing fine powders.
- They can also be used as freeze and mixing trays for small batches and also during microwave moisture analysis.
- Guarantees chemical and temperature resistance between -10°C to +70°C.
- Flat bottom ensures perfect stability on counters while smooth and non-porous inner surface provides accurate pour outs with minimal sample loss.

Non-sterile dishes are packed as 100 pieces.
Sterile dishes are packed as 10 pieces.



dish color	diamond dishes non-sterile	diamond dishes gamma sterile	dish volume	square dishes non-sterile	square dishes gamma sterile	dish volume
white	037.05.005	037.15.005	5 ml	037.09.007	037.19.007	7 ml
white	037.05.030	037.15.030	30 ml	037.09.100	037.19.100	100 ml
white	037.05.100	037.15.100	100 ml	037.09.250	037.19.250	250 ml
black	037.06.005	037.16.005	5 ml	037.11.007	037.21.007	7 ml
black	037.06.030	037.16.030	30 ml	037.11.100	037.21.100	100 ml
black	037.06.100	037.16.100	100 ml	037.11.250	037.21.250	250 ml



With a slight pressure to the sides weighing dishes can easily be converted into a pouring funnel for easy and non-spill transfer of samples.



WEIGHING DISHES "aluminum"

- Manufactured from high grade, oil free, durable and light gauge aluminium.
- Unique design guarantees excellent use with moisture determination balances.
- Can also be used as a mixing or weighing pan.
- Wall with 8 mm height guarantees spill-free application.
- Easily stackable due to the tapered body form for reducing storage space.

catalogue number	Ø x H (mm)	pack quantity
037.25.100	100x7	50 pieces



WEIGHING DISHES "aluminum"

- Manufactured from high grade, oil free, durable and light gauge aluminium. Featured with compressed walls for extra stability.
- Designed to be used as weighing dishes, evaporating dishes or drying dishes.
- Featured with a handle which enables easy holding of the dish. Can also be used as a marking surface.
- Easily stackable due to the tapered body form for reducing storage space.

catalogue number	Ø x H (mm)	pack quantity
037.24.045	49x12	100 pieces
037.24.055	60x15	100 pieces
037.24.065	66x16	100 pieces



WEIGHING DISHES "aluminum"

- Manufactured from high grade, oil free, durable and light gauge aluminium. Featured with compressed walls for extra stability.
- Unique design offers variety of applications. They can be used as weighing dishes, as mixing dishes also even as dishes for storing samples.
- Easily stackable due to the tapered body form for reducing storage space.

catalogue number	Ø x H (mm)	pack quantity
037.23.070	70x22	100 pieces
037.23.085	88x38	100 pieces
037.23.110	110x34	100 pieces

density & sedimentation & temperature & time & pH & weight measurement



WEIGHING SCOOPS - "glass"

➤ Made from glass with flat base ensuring stability on the balance pans.

➤ Hollow stem enables very easy powder transfer.

catalogue number	max. volume	pack quantity
037.07.001	3 ml	1 piece
037.07.002	6 ml	1 piece
037.07.003	10 ml	1 piece



WEIGHING SCOOPS - "stainless steel"

➤ Manufactured from stainless steel.

➤ Highly polished smooth interior provides accurate pour outs without sample loss.

catalogue number	length	pack quantity
037.04.001	95 mm	1 piece
037.04.002	117 mm	1 piece
037.04.003	125 mm	1 piece



WATCH GLASSES - "glass"

➤ Manufactured from soda-lime glass according to DIN 12341 standard. Ideal tools also for evaporation applications and for covering the hot beakers.

➤ Fire polished edges prevent chipping and avoid breakage.

catalogue number	Ø (mm)	pack quantity
037.01.050	50	10 pieces
037.01.060	60	10 pieces
037.01.070	70	10 pieces
037.01.080	80	10 pieces
037.01.100	100	10 pieces
037.01.125	125	10 pieces
037.01.150	150	10 pieces
037.01.200	200	10 pieces



WEIGHING BOTTLES - "glass"

➤ Manufactured from heat resistant, durable borosilicate glass complete with a lid.

➤ The interchangeable lids perfectly fit to the NS necks. Once closed they provide hermetical closure.

catalogue number	Ø x H (mm)	pack quantity
037.02.254	25 x 40	1 piece
037.02.353	35 x 30	1 piece
037.02.402	40 x 25	1 piece
037.02.305	30 x 50	1 piece
037.02.503	50 x 30	1 piece
037.02.357	35 x 70	1 piece
037.02.603	60 x 30	1 piece
037.02.408	40 x 80	1 piece
037.02.803	80 x 30	1 piece
037.02.508	50 x 80	1 piece



WEIGHING PAPER

➤ Manufactured from impervious and transparent paper specially suitable for weighing.

➤ Leaves no residue and impurity during and after weighing application.

➤ Cut as 100 x 100 mm dimensions and packed as a booklet of 250 papers.

catalogue number	pack quantity
037.33.001	1 booklet



WEIGHING BRUSH

➤ Ideal tool for cleaning weighing boats, balance pans, weighing dishes and any similar object.

➤ Manufactured from extremely soft anti-static natural hair.

➤ Pointed tip provides excellent effective cleaning.

catalogue number	pack quantity
037.32.001	1 piece



DENSITY BOTTLES - "non - calibrated & calibrated"

- All density bottles are manufactured according to ISO 3507 standard. For easy differentiation both the body and the stopper carries the same identification code number.
- They are supplied with a stopper with excellently polished upper and lower ends. Nominal volume and inscriptions are printed with blue enamel.
- **Non-calibrated density bottles** are supplied without calibration.
- **Calibrated density bottles** are calibrated together with the stopper with a precision of 0,001 ml. Net volume is engraved on the body.

- **Calibrated density bottles** with thermometer are calibrated together with the stopper with a precision of 0,001 ml. Net volume is engraved on the body. Supplied with a thermometer of scale range +10°C to +40°C, with scale 0,5°C.

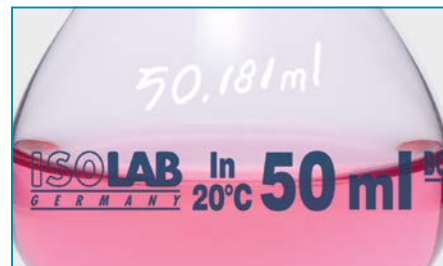

Net volume with 0,001 ml precision is engraved on the body of calibrated density bottles.

volume	non-calibrated density bottles	calibrated density bottles	calibrated density bottles with thermometer	pack quantity
5 ml	023.01.005	023.02.005	023.03.005	1 piece
10 ml	023.01.010	023.02.010	023.03.010	1 piece
25 ml	023.01.025	023.02.025	023.03.025	1 piece
50 ml	023.01.050	023.02.050	023.03.050	1 piece
100 ml	023.01.100	023.02.100	023.03.100	1 piece

IMHOFF CONES

- Manufactured from heat resistant, durable borosilicate glass according for sedimentation tests according to DIN 12672 standard.

- Featured with volume graduation of 1000 ml. Volume graduations and inscriptions are printed with white enamel.

graduation range	subdivision
0 - 2 ml	0,1 ml
> 2 - 10 ml	0,5 ml
> 10 - 40 ml	1,0 ml
> 40 - 100 ml	2,0 ml
> 100 - 1000 ml	50,0 ml

catalogue number	cone type	pack quantity
043.20.001	without stopcock	1 piece
043.20.002	with stopcock	1 piece



IMHOFF CONE STANDS

- Manufactured to hold two imhoff sedimentation cones of any type.

- Compact design allows easy carry of imhoff cones even when the cones are filled.

catalogue number	rack type	pack quantity
043.22.002	PMMA	1 piece

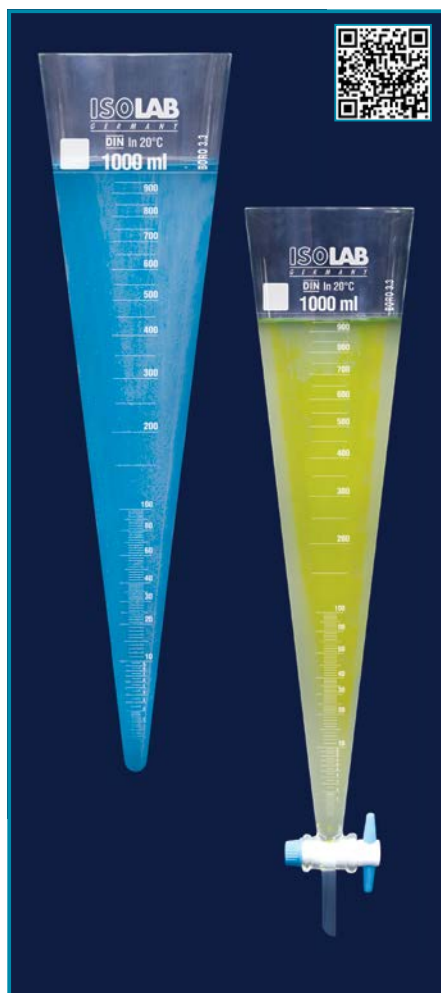



*stirring & mixing
shaking & heating
cooling*

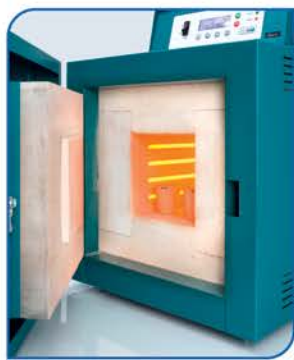

stirring & mixing & shaking & heating & cooling



MAGNETIC STIRRER - "with hot plate"

catalogue no	613.06.001
dimensions	215x360x112 mm
weight	5,3 kg
plate size	184 x 184 mm
top plate	glass ceramic
motor type	DC motor
power	1050 W
voltage	100 - 240 V
frequency	50 / 60 Hz
capacity	20 L
range	100 - 1500 rpm
display	LCD
output	1000 W
range	room temp - 550°C
accuracy	±1 % > 100°C
safety temp.	580°C
warning	50°C
accessories	sensor PT 1000

- Featured with an explosion proof brushless DC motor with low noise level offers a stirring volume up to 20 lt.
- Ceramic top plate guarantees perfect chemical resistance against acids.
- Integrated the heater provides excellent heat transfer rate and quick heat up.
- Aluminium alloy housing protects all components from aggressive effects and guarantees safety with a long life time.
- Electronic speed control from 100 to 1500 rpm provides a precise stirring.
- LCD panel for display for set & actual temperature and set & actual speed.
- Guarantees excellent heating control from ambient temperature to 550°C.
- Overheat protection circuit turns off the heater if the top plate temperature reaches 580°C for any reason. LCD display will show "HOT" if hotplate temperature is over 50°C.
- Supplied complete with PT1000 temperature sensor, support rod and fixing clamp.



MAGNETIC STIRRER - "with hot plate"

catalogue no	613.01.001
dimensions	268x160x86 mm
weight	1,8 kg
plate size	Ø135
top plate	stainless steel
motor type	DC motor
power	630 W
voltage	100 - 240 V
frequency	50 / 60 Hz
capacity	3 L
range	100 - 1500 rpm
display	LED
output	600 W
range	room temp - 280°C
accuracy	±0.1°C
safety temp.	50 - 320°C
warning	50°C
accessories	sensor PT 1000

- Featured with an brushless DC motor with low noise level offers a stirring volume up to 3 lt.
- Ceramic top plate guarantees perfect chemical resistance against acids.
- Integrated the heater provides excellent heat transfer rate and quick heat up.
- ABS housing protects all components from aggressive effects and guarantees safety with a long life time.
- Electronic speed control from 100 to 1500 rpm provides a precise stirring.
- LED panel for display for set & actual temperature and set & actual speed.
- Guarantees excellent heating control from ambient temperature to 280°C.
- Overheat protection circuit turns off the heater if the top plate temperature reaches 320°C for any reason.
- Supplied complete with PT1000 temperature sensor.
- Please kindly order support rod separately **Cat. No 613.01.102**

stirring & mixing & shaking & heating & cooling



MAGNETIC STIRRER - "without hot plate"

catalogue no	613.03.001
dimensions	150x260x80 mm
weight	1,8 kg
plate size	Ø135
motor type	DC motor
power	15 W
voltage	220 V
frequency	50 / 60 Hz
capacity	3 L
range	100 - 1500 rpm
display	LED

➤ Maintenance free DC motor with low noise level offers a stirring volume up to 3 lt with a smooth start and quick stop.

➤ Electronic speed control from 100 to 1500 rpm provides a gentle revolution and precise stirring speed even at maximum speed range.

➤ Large LED panel offers simultaneous display for set & actual speed.

➤ ABS housing protects all mechanical and electronic components from aggressive effects and guarantees safety with a long life time.

➤ Also provides impact resistant, easily cleanable, scratch-proof surface.



MAGNETIC STIRRER - "without hot plate"

catalogue no	613.05.001
dimensions	150x145x50 mm
weight	0,3 kg
plate size	Ø120
motor type	DC motor
power	7,2 W
voltage	220 V
frequency	50 / 60 Hz
capacity	1,5 L
range	300 - 2000 rpm
display	N/A

➤ This light weight, compact designed magnetic stirrer is specially recommended for titration applications.

➤ Electronic speed control from 300 to 2.000 rpm provides precise stirring speed even at maximum speed range.

➤ DC motor offers a stirring volume up to 1,5 lt with a smooth start and quick stop.

➤ PET housing protects components from aggressive effects.

➤ Anti-slip silicone feet pads minimize vibration and guarantee excellent stability.

➤ Featured with an adjustable clamp holder suitable to hold electrodes and other probes.



MAGNETIC STIRRER - "without hot plate"

catalogue no	613.07.001
dimensions	115x175x12 mm
weight	0,35 kg
plate size	Ø100
motor type	Magnetic motor
power	5 W
voltage	220 V
frequency	50 / 60 Hz
capacity	0,8 L
range	15 - 1500 rpm
display	N/A

➤ This ultra-flat, compact designed magnetic stirrer with only 350 gr weight can be carried even in a pocket.

➤ Specially recommended for titration applications. Offers a stirring volume up to 0,8 lt with a smooth start and quick stop.

➤ Electronic speed control from 15 to 1500 rpm provides precise stirring speed even at maximum speed range.

➤ Featured with automatic reverse rotation function for more efficient mixing.

➤ ABS housing protects all components from aggressive effects.

➤ Also provides impact resistant, easily cleanable, scratch-proof surface.

stirring & mixing & shaking & heating & cooling



MAGNETIC STIRRING BARS
"cylindrical"

- Manufactured from ALNICO (an alloy of aluminium, nickel, iron and cobalt) magnets encapsulated with PTFE coating.
- Cylindrical magnetic stirring bars offer for a wide variety of applications providing excellent mixing effect.
- Polished finish provides excellent centering and smooth uninterrupted stirring.
- Their perfect contacts with the base of the flask reduce the risk of ricochet during stirring.

catalogue number	length	diameter	pack quantity
057.01.010	10 mm	6 mm	10 pieces
057.01.015	15 mm	6 mm	10 pieces
057.01.020	20 mm	6 mm	10 pieces
057.01.025	25 mm	6 mm	10 pieces
057.01.030	30 mm	6 mm	10 pieces
057.01.035	35 mm	6 mm	10 pieces
057.01.040	40 mm	8 mm	10 pieces
057.01.045	45 mm	8 mm	10 pieces
057.01.050	50 mm	8 mm	6 pieces
057.01.060	60 mm	9 mm	6 pieces
057.01.070	70 mm	9 mm	6 pieces
057.01.080	80 mm	9 mm	6 pieces



MAGNETIC STIRRING BARS
"oval - elliptical"

- Manufactured from ALNICO (an alloy of aluminium, nickel, iron and cobalt) magnets encapsulated with PTFE coating.
- These elliptic magnetic stirrer bars provide excellent mixing effect specially when used with round bottom flasks.
- Their egg shapes guarantee unrestricted spinning and effective mixing by perfect adaptation of the vessel contour.

catalogue number	length	diameter	pack quantity
057.05.020	20 mm	8 mm	1 piece
057.05.025	25 mm	10 mm	1 piece
057.05.030	30 mm	11 mm	1 piece
057.05.035	35 mm	12 mm	1 piece
057.05.040	40 mm	15 mm	1 piece



MAGNETIC STIRRING BARS
"cross form"

- Manufactured from ALNICO (an alloy of aluminium, nickel, iron and cobalt) magnets encapsulated with PTFE coating.
- Cross formed magnetic stirring bar creates a deep vortex even at relatively slow speeds and provides an excellent mixing.
- Their angled body forms reduce the friction effect during stirring and provide excellent centering and smooth uninterrupted stirring.
- Their perfect contacts with the base of the flask reduce the risk of ricochet during stirring.

catalogue number	dimensions	pack quantity
057.06.037	37 x 37 mm	1 piece



BOX - "with compartments" - "acrylic"

- Manufactured from acrylic featured with different size compartments. Offers practical positioning and easy reach of different size small objects such as magnetic stirrers.
- The long compartment is ideal to store longer objects including magnetic bar retrievers. Featured with a lid protecting the box interior from environmental conditions.

catalogue number	box width	box length	box height	compartment quantity	pack quantity
057.02.101	330 mm	110 mm	35 mm	12	1 piece



STIRRING ROD - "glass"

- Glass rods are manufactured from rods with different diameters and lengths.
- Their flame polished ends prevents unexpected breakage during applications. They offer practical solutions for mixing and stirring solutions by hand.

glass stirring rod	length	diameter	pack quantity
057.03.200	200 mm	5 mm	10 pieces
057.03.250	250 mm	6 mm	10 pieces
057.03.300	300 mm	6 mm	10 pieces

MAGNETIC BAR RETRIEVERS

- Constructed with a PTFE encapsulated powerful magnet at the end of a long stem.
- Essential tool for picking up the magnetic stirring bars from flasks after use without losing them.
- They offer risk-free removal of magnetic stirring bars even from aggressive liquids and reduce the risk of magnetic bar loss.
- **Alternative 2 retrievers:**
 - With solid stem
 - With flexible stem
- Magnetic bar retriever with flexible stem guarantees easy reach to the edges of the cornered flasks such as erlenmeyers.

catalogue number	retriever model	stem length	pack quantity
057.02.001	solid stem	260 mm	1 piece
057.02.002	flexible stem	300 mm	1 piece

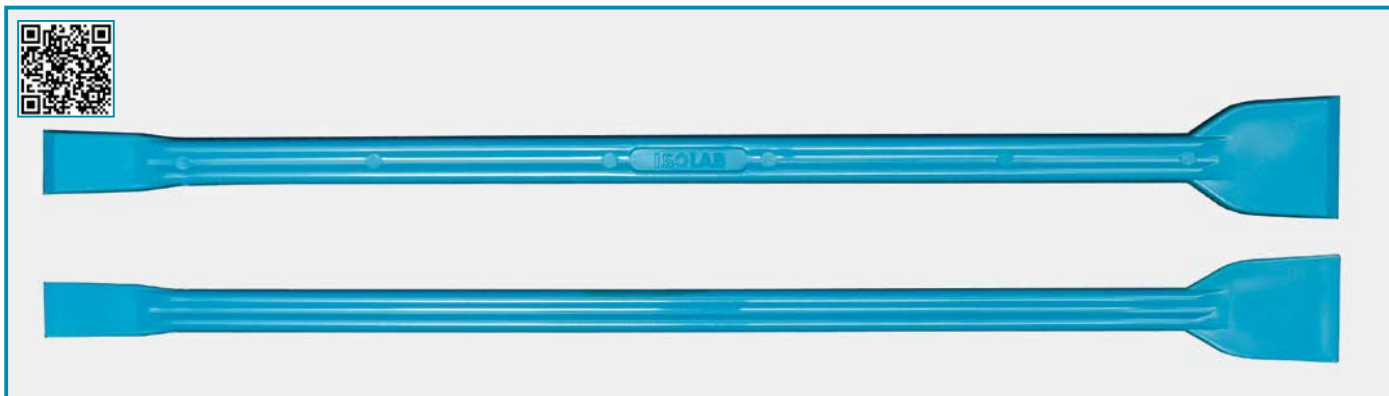
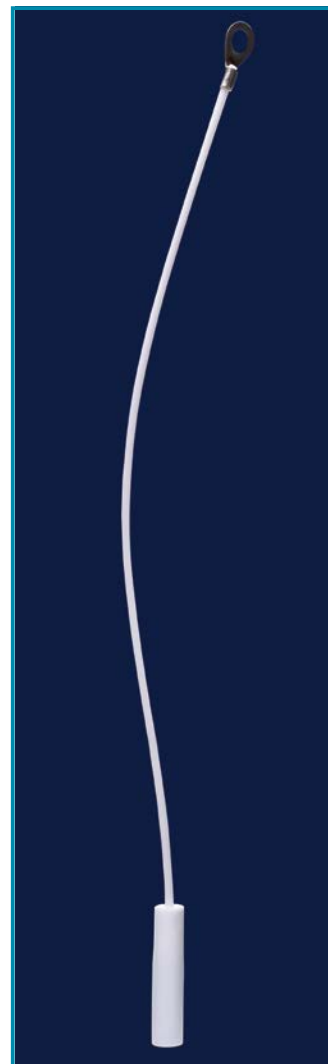

STIRRING ROD - "polypropylene"

- Manufactured from polypropylene with a flattened ends for effective mixing.
- Offers practical solutions for mixing and stirring solutions both for narrow and wide neck flasks.
- Featured with two flat ends with different widths on a single handle.
- Flat ends have 35 degree sharp edges for easy removal of the residues on flat surfaces.

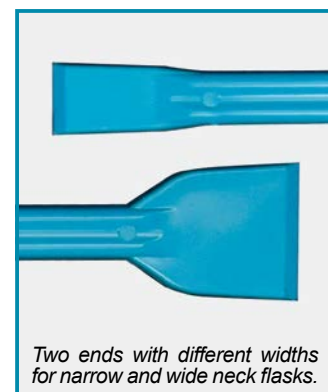
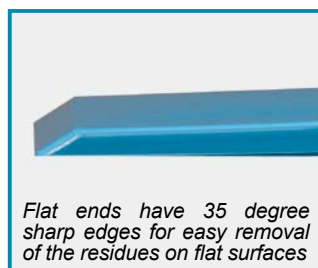

catalogue number	total length	narrow end width	large end width	pack quantity
057.04.251	240 mm	12 mm	23 mm	10 pieces



MECHANICAL STIRRER - "light duty"

catalogue no	615.01.001
dimensions	83x220x186 mm
weight	2,6 kg
motor type	DC motor
power	70 W
voltage	100 - 240 V
frequency	50 / 60 Hz
capacity	20 L
range	0 - 2200 rpm
display	LED
resolution	± 1 rpm
max. torque	40 Ncm
max. viscosity	10000 mPas
chuck dia.	0,5 - 10 mm

► Highly reliable design for stirring low to medium viscous media with a vibration free and silent operation.

► Maintenance free, silent and explosion proof DC motor offers a stirring volume up to 20 l with a smooth start without sample overflow and a quick stop.

► Sturdy aluminium main body efficiently absorbs and emits the heat generated by the motor.

► Electronic speed control from 0 to 2200 rpm provides a gentle revolution and precise stirring speed even at high temperatures.

► Large LED panel for simultaneous display for set & actual speed.

► Overload safety feature automatically stops the operation and protects all mechanical and electronic components.

► Stirring shafts can be easily inserted to their position by "push through" system.

► Stirring shaft, stand and fixing clamp are not supplied as a standard accessory. These should be ordered separately.

accessories for mechanical stirrer - "stand & bosshead"



Bosshead manufactured from steel with opening distance of 0 - 20 mm.

Sturdy construction specially enables holding heavy objects such as stirrers.
Catalogue No: 615.01.012

Stirrer stand is made from powder coated cast steel.

Unique base design offers very stable holding of the assembled stirrer and also possibility of getting close to the stand rod.

Supplied complete with 14 mm diameter stainless steel support rod.
Catalogue No: 049.09.250

accessories for mechanical stirrer - "stirring shafts"

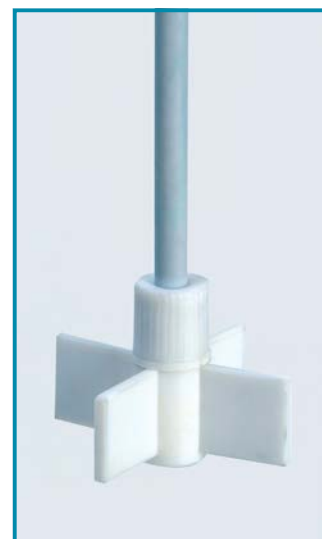

catalogue number	shaft type	shaft dia. & length	shaft material	recommended for
615.01.101	cross	9,0 x 400 mm	st. steel	medium & high speed
615.01.103	cross	8,5 x 350 mm	PTFE	medium & high speed

stirring & mixing & shaking & heating & cooling

HOMOGENIZER - "light duty"

catalogue no	621.11.001
dimensions	45x55x230 mm
weight	0,6 kg
motor type	carbon brush
power	160 W
voltage	220 V
frequency	50 Hz
range	8000 - 30000 rpm
control	6 stage
max. viscosity	5000 mPas
working volume	0,1 - 50 ml with shaft 621.11.050
working volume	1 - 250 ml with shaft 621.11.250

➤ Practical solution if mixing, emulsification, shredding or chopping is required for small samples.

➤ High torque motor with a variable speed adjustment enables rapid and effective disruption of a wide range of samples.

➤ Speed control as 8.000, 12.000, 15.000, 18.000, 22.000, 30.000 rpm.

➤ Different rotors and stators enables adaptation to most applications.

➤ Can homogenize samples in range 0,1 ml to 50 ml or 1 ml - 250 ml of liquid depending on the rotor/stator type.

➤ Maximum speed of 30.000 rpm rate reduces processing time significantly.

➤ Complete homogenization of samples is usually achieved in a few seconds.

➤ Smooth motor drive makes working very safe and comfortable.

➤ Smooth acceleration also prevents unnecessary spills. An overload protection feature increases the life span of the motor.

"shafts" & "rotors" and "stators"

➤ Shafts, rotors, stators are not supplied as a standard accessory. These should be ordered separately.

➤ Assembly and disassembly of rotors can be done without requirement of special tools.

➤ Shafts, rotors and stators are constructed of quality AISI 316 stainless steel which is inert to aggressive solutions



Light duty homogenizer is supplied without bosshead, clamp, stand and rotor/stator set.

Bosshead manufactured from steel with opening distance of 0 - 20 mm.
cat. no: 615.01.012

Stirrer stand is made from powder coated cast steel.

Unique base design offers very stable holding of the assembled stirrer and also possibility of getting close to the stand rod.

Supplied complete with 12 mm diameter st. steel support rod.
cat. no: 049.09.180

Bosshead clamp is specially suitable to hold light duty homogenizer.
cat. no: 621.11.103



For liquid / solid media
working volume: 0,1 - 50 ml
621.11.050



For liquid / solid media
working volume: 1 - 250 ml
621.11.250

stirring & mixing & shaking & heating & cooling

WATER BATHS

- Water tank is manufactured from cavitation-proof, seamless and corrosion resistant stainless steel.
- Alarm and timer functions can be automatically controlled by membrane keypad with digital LED panel.
- Integrated heater design provides homogenous heat distribution rate and enables rapid heating up.
- Integrated PID temperature technology enables excellent heating control from ambient +5°C to 99°C with accuracy of +/- 0,1°C.
- Integrated overheat protection with alarm circuit automatically turns off heating in case of overheating.
- Automatic timer with aural and visual alarm functions enables selective operation as "continuous" mode or 99 minutes and 99 hours.
- Perforated bottom tray protects heating element and temperature sensor.
- Delivered complete with flat type stainless steel lid.



Seamless, robust cavitation-proof, stainless steel water tank. Perforated bottom tray protects heating element and temperature sensor. Baths are supplied with a stainless steel flat lid.

catalogue number	602.01.001	602.02.001
external dimensions (mm)	327 x 265 x 280	537 x 327 x 280
tank dimensions (mm)	300 x 240 x 150	500 x 295 x 150
tank volume (L)	11	22
heating output (W)	700	1400
heating range (°C)	ambient + 5 to 99	ambient + 5 to 99
heating control	PID technology	PID technology
heating accuracy (°C)	±0,1	±0,1
tank temp. uniformity	±1	±1
voltage (V)	220	220
frequency (Hz)	50/60	50/60
time & temp. display	LED	LED
time control	99 min. - 99 hour	99 min. - 99 hour
over heat protection	yes	yes
standard accesories	st. steel lid	st. steel lid



Membrane keypad with digital LED panel with timer, alarm and auto-tuning functions. Timer with delayed on/off function can be set selectively either to 99 min. 59 sec. or 99 hour 59 min.

WATER CONDITIONER

- Highly effective special softener for water baths.
- Extremely gentle on ware with almost neutral pH value.
- Fully water soluble, low-foaming, low phosphate content, non-combustible, no gas formation, non-aggressive, biodegradable.
- Recommended 2 ml added to each 1 lt exchanged water.

catalogue number	pack quantity
602.01.101	500 ml bottle



Recommended 5 ml added to 1 liter new changed fresh water.



HEATING MANTLES - "without stirrer"

- Designed heating and boiling liquids in various size of round bottom flasks from 100 ml to 10.000 ml.
- Time proportional heater control with excellent repeatability enables a temperature operating range to 450°C.
- Heating element is made of highly flexible heat-resistant glass yarn which performs a maximum temperature of 900°C.
- Flexible heating element absorbs shocks, minimizing the risk of flask breakage and guarantees uniform heat distribution.
- Outer casing is manufactured from easy to clean powder coated steel.
- Glass fibre outer insulation with excellent ventilation slots keeps the outer casing cool at all times.
- Featured with non-skid rubber feet enabling perfect stability during operation.
- Control panel has separate indicator lamps for power and heat functions.



Heating element is made of highly flexible heat-resistant glass yarn which performs at maximum temperature of 900°C.

catalogue no	608.11.100	608.11.250	608.11.500	608.11.901	608.11.902
Voltage	220 V				
Frequency	50 Hz				
Power	100W	150 W	250 W	350 W	450 W
Max. Heating	450°C				
Capacity	100 ml	250 ml	500 ml	1000 ml	2000 ml



HEATING MANTLES - "with stirrer"

- Designed to control both heating power and stirring speed independently.
- Time proportional heater control with excellent repeatability enables a temperature control to 450°C.
- Heating element is made of highly flexible heat-resistant glass yarn which performs a maximum temperature of 900°C.
- Flexible heating element absorbs shocks, minimizing the risk of flask breakage and guarantees uniform heat distribution.
- Provides a stirring speed up to 1.400 rpm with an integrated magnetic stirrer.
- For effective stirring, place the correct model and size of magnetic stirrer into the flask and increase the stirring speed slowly from minimum level.
- Outer casing is manufactured from easy to clean powder coated steel.
- Glass fibre outer insulation with excellent ventilation slots keeps the outer casing cool at all times.
- Featured with non-skid rubber feet enabling perfect stability during operation.
- Control panel has separate indicator lamps for heating and stirring functions.

catalogue no	608.12.100	608.12.250	608.12.500	608.12.901
voltage	220 V			
frequency	50 Hz			
power	100 W	150 W	250 W	350 W
max. heating	450°C			
capacity	100 ml	250 ml	500 ml	1000 ml
stirring	0 - 1400 rpm			

stirring & mixing & shaking & heating & cooling

VORTEX MIXER - "advanced"



catalogue no	622.01.001
dimensions	127x130x160 mm
weight	3 kg
power	60 W
voltage	220 V
frequency	50 / 60 Hz
motion	orbital
motion dia.	4 mm
run time	continuous / touch
range	0 - 2500 rpm
display	scale

- Offers touch and continuous orbital mixing. Provides mixing with adjustable speed control from 0 to 3000 rpm.
- Guarantees perfect mixing of a 50 ml tube in 3 seconds.
- Unique counter-balance system creates maximum vortex power.
- Aluminium cast and silicone feet pads minimize the vibration avoiding "walking".
- Reliable and extremely quiet motor guarantees an even distributed mixing.
- Can be used both in cold rooms, incubators and anaerobic and aerobic chambers due to the small foot print and extremely compact design.

VORTEX MIXER - "LED display"



catalogue no	622.03.001
dimensions	110x145x160 mm
weight	3 kg
power	20 W
voltage	220 V
frequency	50 / 60 Hz
motion	orbital
motion dia.	5 mm
run time	continuous / touch
range	0 - 3000 rpm
display	LED

- Offers touch and continuous orbital mixing.
- Provides efficient mixing with infinitely adjustable electronic speed control from 0 to 3000 rpm.
- Operation time can be set and controlled electronically between 1 second to 100 minutes. User friendly large LED displays enable easy setting and reading of speed and time.
- Guarantees perfect mixing of a 50 ml tube in 5 seconds with 6 mm diameter orbital movement.
- Other technical specifications are same as 622.01.001.

VORTEX MIXER - "basic"



catalogue no	622.02.001
dimensions	100 mm dia. x 78 mm
weight	0,55 kg
power	12 W
voltage	100 - 240 V
frequency	50 / 60 Hz
motion	orbital
motion dia.	5,5 mm
run time	continuous / touch
range	3000 rpm
display	N/A

- Offers perfect orbital vortex mixing with a single touch. Provides efficient mixing with fixed speed of 3000 rpm.
- Guarantees perfect mixing of a 50 ml tube in 3 seconds with 6 mm diameter orbital movement.
- Unique counter-balance system creates maximum vortexing while minimizing the noise and vibration.
- Reliable and extremely quiet motor guarantees an even distributed mixing.
- Can be used in limited areas due to the small foot print and extremely compact design.



ISOLAB

Laborgeräte GmbH

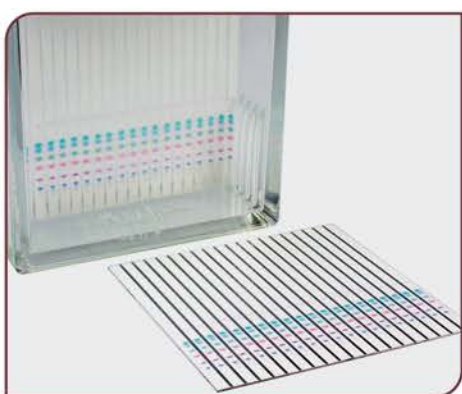

chromatography & spectroscopy



SYRINGE FILTERS - "non-sterile" - "sterile"



- Specially designed for HPLC sample preparations with the best quality tear proven membranes. Fully autoclavable.
- Since the housing is ultrasonically sealed they offer excellent pressure stability.
- Sample distribution rings of the body direct samples for uniform filtration with a guarantee of high flow rate and filtration speed on both directions restricting the liquid overload.
- Unique female luer-lock secures connections with syringes. Body design enables to be used with all robotic machines.
- Membrane type and porosity printed on each filter. Different colour coded sealing rings in MN enable easy differentiation of the membrane type.
- Available 2 filters:
 - Syringe filters with 0,45 µm pore size
 - Syringe filters with 0,22 µm pore size

ISOLAB non-sterile 0,45 µm filters	ISOLAB sterile 0,45 µm filters	Macherey - Nagel non-sterile 0,45 µm filters	Macherey - Nagel sterile 0,45 µm filters	filter membrane material	code name	pore size µm	diameter	pack quantity
094.01.001	094.05.001	094.02.001		regenerated cellulose	RC	0.45	25 mm	100 pieces
094.01.002	094.05.002	094.02.002		polytetrafluoroethylene	PTFE	0.45	25 mm	100 pieces
094.01.003	094.05.003	094.02.003		polyvinylidenedifluoride	PVDF	0.45	25 mm	100 pieces
		094.02.004		polyester	PET	0.45	25 mm	100 pieces
094.01.005	094.05.005	094.02.005		cellulosemixedesters	MV	0.45	25 mm	100 pieces
094.01.006	094.05.006	094.02.006	094.06.006	cellulose acetate	CA	0.45	25 mm	100 pieces
094.01.007	094.05.007	094.02.007		nylon / polyamide	PA	0.45	25 mm	100 pieces
094.01.008	094.05.008	094.02.008		polyethersulfone	PES	0.45	25 mm	100 pieces

ISOLAB non-sterile 0,22 µm filters	ISOLAB sterile 0,22 µm filters	Macherey - Nagel non-sterile 0,22 µm filters	Macherey - Nagel sterile 0,22 µm filters	filter membrane material	code name	pore size µm	diameter	pack quantity
094.03.001	094.07.001	094.04.001		regenerated cellulose	RC	0.22	25 mm	100 pieces
094.03.002	094.07.002	094.04.002		polytetrafluoroethylene	PTFE	0.22	25 mm	100 pieces
094.03.003	094.07.003	094.04.003		polyvinylidenedifluoride	PVDF	0.22	25 mm	100 pieces
		094.04.004		polyester	PET	0.22	25 mm	100 pieces
094.03.005	094.07.005	094.04.005		cellulosemixedesters	MV	0.22	25 mm	100 pieces
094.03.006	094.07.006	094.04.006	094.08.006	cellulose acetate	CA	0.22	25 mm	100 pieces
094.03.007	094.07.007	094.04.007		nylon / polyamide	PA	0.22	25 mm	100 pieces
094.03.008	094.07.008	094.04.008		polyethersulfone	PES	0.22	25 mm	100 pieces

MV = cellulose mixed esters, **CA** = cellulose acetate, **RC** = regenerated cellulose, **PA** = polyamide, **PTFE** = polytetrafluoroethylene, **PVDF** = polyvinylidene difluoride, **PES** = polyethersulfone, **PET** = polyester

SYRINGES - "polypropylene" - "sterile"



- 2 pieces syringes are suitable for HPLC applications. Sterile, pyrogen-free and for single use, latex and silicone oil free.
- Consists of very clear, highly transparent and absolutely leak-tight polypropylene barrel and polyethylene piston.
- Ergonomically designed for single-handed operation. Featured with accurate graduated scale marking.
- Smooth piston movement offers reduced sliding force.
- Defined position at "0" volume level to feel when piston is completely inserted.
- Defined safety stop to avoid accidental pull-out of plunger and loss of sample.
- Supplied without syringe needles. Packed in individual blister packing.

catalogue number	volume	overall length	pack quantity
094.91.002	2 ml	87 mm	300 pieces
094.91.005	5 ml	87 mm	225 pieces
094.91.010	10 ml	100 mm	150 pieces
094.91.020	20 ml	115 mm	100 pieces



MEMBRANE FILTERS

➤ Membrane filtration offer a very convenient, fast and economical separation method.

They offer below mentioned advantages;

- ✓ Excellent level of particle retention
- ✓ Large load carry capacity
- ✓ High permeability to air
- ✓ Non-hygroscopic and biologically inert
- ✓ Chemical resistance to most solvents and reagents.
- ✓ Very high temperature resistance

➤ Available 2 filters: ➤ filters with 0,45 µm pore size
➤ filters with 0,20 µm pore size



CM: cellulose mixed ester membrane

Particularly suitable for aqueous solutions. They are hydrophilic. Thermally stable to 121°C. Ideal for gravimetric analysis and are often used for contamination tests.

NC: nitrocellulose membranes

They are easily wettable and suited for filtration of aqueous solutions. In dry atmosphere these membranes are thermally stable at 125°C and can be autoclaved at 121°C.

RC: regenerated cellulose membranes

These membranes are resistant to most organic solvents. They are mostly used for filtration of solvent mixtures and ultra-purification and degassing of HPLC eluents.

PTFE: polytetrafluoroethylene membranes

Particularly suitable with aggressive media, as well as to concentrated acids and bases. They are hydrophobic, they can be used up to 145°C.

PE: polyester membranes

They are hydrophilic. Particularly suitable for fine titration, dust analysis, aerosol analysis and ultra-purification of solvents.

CA: cellulose acetate membranes

They have a low protein binding capacity and they are suited for aqueous and alcoholic media. They are hydrophobic and can be used for hot gases up to 180°C.

catalogue number	membrane material	code name	pore size	diameter	pack quantity
104.01.001	cellulose mixed ester	CM	0,20 µm	47 mm	100 pieces
104.01.002	cellulose mixed ester	CM	0,45 µm	47 mm	100 pieces
104.01.003	nitrocellulose	NC	0,20 µm	47 mm	100 pieces
104.01.004	nitrocellulose	NC	0,45 µm	47 mm	100 pieces
104.01.005	regenerated cellulose	RC	0,20 µm	47 mm	100 pieces
104.01.006	regenerated cellulose	RC	0,45 µm	47 mm	100 pieces
104.01.007	polytetrafluoroethylene	PTFE	0,20 µm	47 mm	100 pieces
104.01.008	polytetrafluoroethylene	PTFE	0,45 µm	47 mm	100 pieces
104.01.009	polyester	PE	0,20 µm	47 mm	100 pieces
104.01.010	polyester	PE	0,45 µm	47 mm	100 pieces
104.01.011	cellulose acetate	CA	0,20 µm	47 mm	100 pieces
104.01.012	cellulose acetate	CA	0,45 µm	47 mm	100 pieces

chromatography & spectroscopy

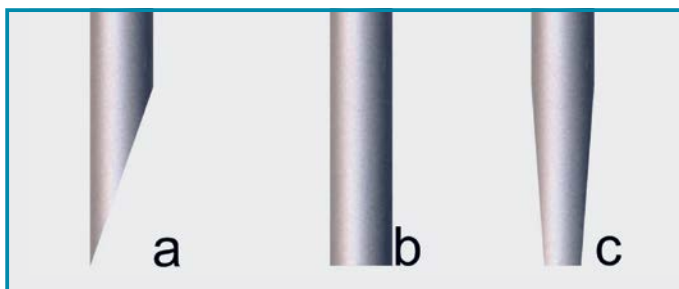

“A” type needles are designed for optimum penetration with 17° bevel. Also minimizes the necessary piercing force and diameter of injection channel.

“B” type needles has a 90° bevel for precise pipetting. This design releases drops completely, for maximum reproducibility. Ideal for HPLC sample injection.

“C” type needles are designed for autosamplers. The tapered tip and the 90° square end eliminate burns. Ideal for PTFE laminated seals and regular septas.

SYRINGES - “for dosage of liquids” - “0 dead volume needle” - “serie T”



Plunger: stainless steel (plunger runs inside the needle)

Barrel: borosilicate glass

Precision: < +/- 1% of the volume

Main use: sample dosage for gas chromatography & dosage of small volume samples & for thin layer chromatography

syringe volume	catalogue number	needle type	catalogue number	needle type	pack quantity
0,5 µl	094.31.005	A	094.32.005	B	1 piece
1,0 µl	094.31.010	A	094.32.010	B	1 piece
2,0 µl	094.31.020	A	094.32.020	B	1 piece
5,0 µl	094.31.050	A	094.32.050	B	1 piece
10 µl	094.31.100	A	094.32.100	B	1 piece
25 µl	094.31.250	A	094.32.250	B	1 piece

SYRINGES - “for dosage of liquids” – “fixed needle” – “serie FN”

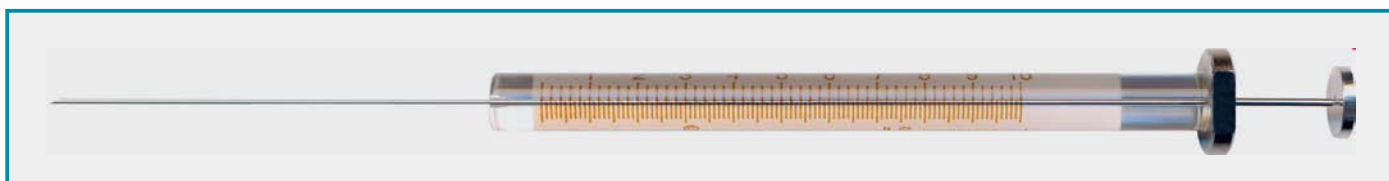

Plunger: stainless steel

Barrel: borosilicate glass

Precision: < +/- 1% of the volume

Main use: sample dosage for gas chromatography & HPLC valves & autosamplers

syringe volume	catalogue number	needle type	catalogue number	needle type	catalogue number	needle type	pack quantity
5 µl	094.11.005	A	094.12.005	B	094.13.005	C	1 piece
10 µl	094.11.010	A	094.12.010	B	094.13.010	C	1 piece
25 µl	094.11.025	A	094.12.025	B	094.13.025	C	1 piece
50 µl	094.11.050	A	094.12.050	B	094.13.050	C	1 piece
100 µl	094.11.100	A	094.12.100	B	094.13.100	C	1 piece
250 µl	094.11.250	A	094.12.250	B	094.13.250	C	1 piece
500 µl	094.11.500	A	094.12.500	B	094.13.500	C	1 piece

SYRINGES - “for dosage of liquids” – “removable needle” – “serie RN”



Plunger: stainless steel

Barrel: borosilicate glass

Precision: < +/- 1% of the volume

Main use: sample dosage for gas chromatography & HPLC valves & autosamplers

syringe volume	catalogue number	needle type	catalogue number	needle type	pack quantity
5 µl	094.21.005	A	094.22.005	B	1 piece
10 µl	094.21.010	A	094.22.010	B	1 piece
25 µl	094.21.025	A	094.22.025	B	1 piece
50 µl	094.21.050	A	094.22.050	B	1 piece
100 µl	094.21.100	A	094.22.100	B	1 piece
250 µl	094.21.250	A	094.22.250	B	1 piece
500 µl	094.21.500	A	094.22.500	B	1 piece

SYRINGES - "for dosage of gas & liquids" – "fixed needle" – "serie H"

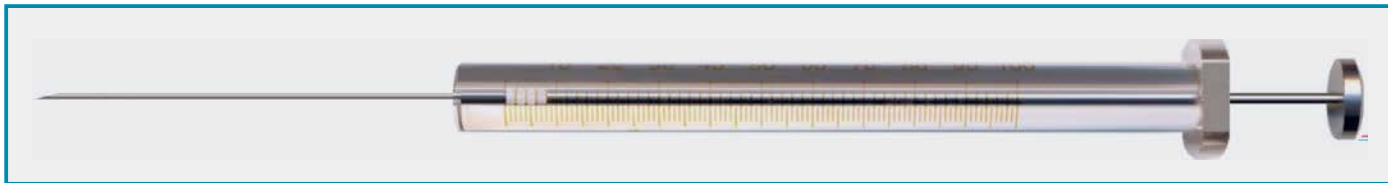

Plunger: stainless steel with PTFE seal

Barrel: borosilicate glass

Precision: < +/- 1% of the volume

Main use: sample dosage for gas chromatography & HPLC valves & autosamplers & dosage of aggressive fluids

syringe volume	catalogue number	needle type	catalogue number	needle type	pack quantity
5 µl	094.41.005	A	094.42.005	B	1 piece
10 µl	094.41.010	A	094.42.010	B	1 piece
25 µl	094.41.025	A	094.42.025	B	1 piece
50 µl	094.41.050	A	094.42.050	B	1 piece
100 µl	094.41.100	A	094.42.100	B	1 piece
250 µl	094.41.250	A	094.42.250	B	1 piece
500 µl	094.41.500	A	094.42.500	B	1 piece
1,0 ml	094.41.901	A	094.42.901	B	1 piece
2,5 ml	094.41.902	A	094.42.902	B	1 piece
5,0 ml	094.41.905	A	094.42.905	B	1 piece
10,0 ml	094.41.910	A	094.42.910	B	1 piece

SYRINGES - "for dosage of gas & liquids" – "removable needle" – "serie H"



Plunger: stainless steel with PTFE seal

Barrel: borosilicate glass

Precision: < +/- 1% of the volume

Main use: sample dosage for gas chromatography & HPLC valves & autosamplers & dosage of aggressive fluids

syringe volume	catalogue number	needle type	catalogue number	needle type	pack quantity
5 µl	094.51.005	A	094.52.005	B	1 piece
10 µl	094.51.010	A	094.52.010	B	1 piece
25 µl	094.51.025	A	094.52.025	B	1 piece
50 µl	094.51.050	A	094.52.050	B	1 piece
100 µl	094.51.100	A	094.52.100	B	1 piece
250 µl	094.51.250	A	094.52.250	B	1 piece
500 µl	094.51.500	A	094.52.500	B	1 piece
1,0 ml	094.51.901	A	094.52.901	B	1 piece
2,5 ml	094.51.902	A	094.52.902	B	1 piece
5,0 ml	094.51.905	A	094.52.905	B	1 piece
10,0 ml	094.51.910	A	094.52.910	B	1 piece

SYRINGES - "glass" - "with luer-lock"

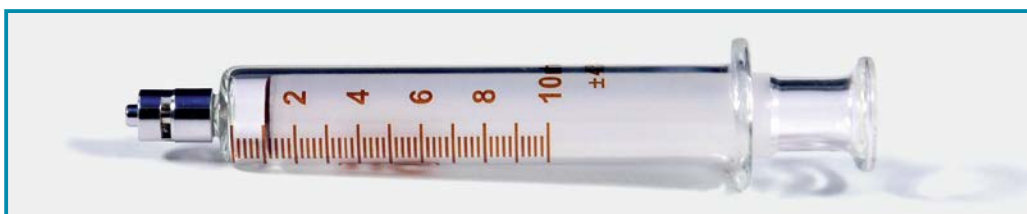

➤ Manufactured from borosilicate glass. Featured with a stainless steel luer-lock system.

➤ Luer-lock grabs the needle or syringe filter stem and guarantees leak-proof delivery of the liquid even under high pressure.

➤ Luer-Barrel and the piston can be repeatedly autoclavable.

➤ Ergonomically designed for single-handed operation.

➤ Smooth piston movement offers reduced sliding force.

catalogue number	volume	overall length	pack quantity
094.92.001	1 ml	85 mm	1 piece
094.92.005	5 ml	105 mm	1 piece
094.92.010	10 ml	130 mm	1 piece
094.92.020	20 ml	145 mm	1 piece
094.92.050	50 ml	180 mm	1 piece

CHROMATOGRAPHY VIALS & SEPTAS & CAPS

In chromatography a wide variety of vials are used as sample containers. As they are mainly used by automatic instruments strict obedience of all dimensions is essential for trouble-free tests. Besides of these physical properties the vials have to fulfill requirements regarding inertness and cleanliness.



chromatography vials

- ✓ Vials are either manufactured from glass or plastic. Glass vials are manufactured from 1st hydrolic glass tubings with low expansion coefficient.
- ✓ Hydrolic glass quality offers perfect resistance to all chemicals and higher hydrolic resistance.
- ✓ Plastic vials are manufactured from polypropylene with a very good resistance to most of the chemicals and high hydrolic resistance.



vial cap without slit

vial cap with slit

septas & caps

- ✓ Sealing units for vials are combination of caps and septas. Caps can be offered either with slit or without slit.
- ✓ For problem-free and correct results seals should also be inert and uncontaminated.
- ✓ Almost all septa are laminated on one side with PTFE, which has a high chemical resistance and forms an inert barrier between the sample in the vial and the cap of the septa.



vial packing

- ✓ Some vials (specially small size ones such as N8, N9 and N11) are packed in a polystyrene boxes.
- ✓ This kind of packing provides guarantees protection against dust and other enviromental effects.
- ✓ The glass clear polystyrene box makes the vials always clearly visible at all times.



cap packing

- ✓ Caps are usually packed in tamper-proof evident zip-locked bags.
- ✓ These bags allow easy identification of the content due to the transparent P.E material.
- ✓ The zip-lock enables resealing of the bag after used.

VIALS - "glass" - "screw cap" - "N8"



- ▶ Manufactured from hydrolic No:1 glass. Supplied without caps & septas.
- ▶ Offers perfect shape, very low dimensional tolerance and exact wall thickness for optimum performance.
- ▶ Featured with volume graduations and marking area.

catalogue number	vial dimensions	volume	color	pack quantity
095.00.001	11,6 x 32 mm	1,5 ml	clear	100 pieces
095.00.002	11,6 x 32 mm	1,5 ml	amber	100 pieces

VIALS - "glass" - "screw cap" - "N9"



- ▶ Manufactured from hydrolic No:1 glass. Supplied without caps & septas.
- ▶ Offers perfect shape, very low dimensional tolerance and exact wall thickness for optimum performance.
- ▶ Featured with volume graduations and marking area.

catalogue number	vial dimensions	volume	color	pack quantity
095.01.001	11,6 x 32 mm	1,5 ml	clear	100 pieces
095.01.002	11,6 x 32 mm	1,5 ml	amber	100 pieces



INSERTS - "glass" "for N8 size vials"

- ▶ Manufactured from hydrolic No:1 glass with perfect shape.
- ▶ Very low dimensional tolerance and exact wall thickness for perfect fit to vials with N8 neck size.
- ▶ Offers perfect solutions for applications where sample volume is limited.

catalogue number	product specifications	volume	vial dimensions	pack quantity
097.05.106	conical bottom	0,1 ml	5,0x31,0 mm	100 pieces
097.05.107	with P.P spring	0,1 ml	5,0x29,0 mm	100 pieces
097.05.108	flat bottom	0,25 ml	5,0x31,5 mm	100 pieces

CAPS & SEPTAS - "for N8 vials"



- ▶ Offer optimum system performance. Designed to work excellently with needles. All of them are specially sized for proper sealings.
- ▶ Packed in tamper-proof evident, transparent, zip-locked bags that allow easy identification.

catalogue number	product specifications	pack quantity
096.00.001	silicone / PTFE - without slit	100 pieces
096.00.002	silicone / PTFE - with slit	100 pieces

CAPS & SEPTAS - "for N9 vials"



- ▶ Offer optimum system performance. Designed to work excellently with needles. All of them are specially sized for proper sealings.
- ▶ Packed in tamper-proof evident, transparent, zip-locked bags that allow easy identification.

for N9 vials	product specifications	pack quantity
096.01.001	silicone / PTFE - without slit	100 pieces
096.01.002	silicone / PTFE - with slit	100 pieces



INSERTS - "glass" "for N9 size vials"

- ▶ Manufactured from hydrolic No:1 glass with perfect shape.
- ▶ Very low dimensional tolerance and exact wall thickness for perfect fit to vials with N9 neck size.
- ▶ Offer perfect solutions for applications where sample volume is limited.

catalogue number	product specifications	volume	vial dimensions	pack quantity
097.05.110	conical bottom	0,2 ml	6,0x31,0 mm	100 pieces
097.05.111	with P.P spring	0,1 ml	5,7x29,0 mm	100 pieces
097.05.109	flat bottom	0,3 ml	5,8x31,5 mm	100 pieces

VIALS - "glass" - "crimp cap" - "N11"



► Manufactured from hydrolic No:1 glass. Supplied without caps & septas.

► Offers perfect shape, very low dimensional tolerance and exact wall thickness for optimum performance.

► Featured with volume graduations and marking area.

CAPS & SEPTAS - "for N11 vials"



► Offer optimum system performance. Designed to work excellently with needles. All of them are specially sized for proper sealings.

► Packed in tamper-proof evident, transparent, zip-locked bags that allow easy identification.

catalogue number	vial dimensions	volume	color	pack quantity
095.02.001	11,6 x 32 mm	1,5 ml	clear	100 pieces
095.02.002	11,6 x 32 mm	1,5 ml	amber	100 pieces

catalogue number	cap type	product specifications	pack quantity
096.02.001	crimp	silicone / PTFE - without slit	100 pieces
096.02.002	crimp	rubber / TEF - without slit	100 pieces

VIALS - "glass" - "screw cap" - "N13"



► Manufactured from hydrolic No:1 glass with perfect shape, very low dimensional tolerance and exact wall thickness for optimum performance.

catalogue number	vial dimensions	volume	color	pack quantity
095.05.001	14,75 x 45 mm	4,0 ml	clear	100 pieces
095.05.002	14,75 x 45 mm	4,0 ml	amber	100 pieces

CAPS & SEPTAS



► Offer optimum system performance. Designed to work excellently with needles. All of them are specially sized for proper sealings. Packed in tamper-proof evident, transparent, zip-locked bags.

catalogue number	product specifications	pack quantity
096.05.003	silicone / PTFE - without slit	100 pieces
096.05.004	rubber / FEP - without slit	100 pieces



VIALS - "glass" - "screw cap" - "N15"



► Manufactured from hydrolic No:1 glass with perfect shape, very low dimensional tolerance and exact wall thickness for optimum performance.

catalogue number	vial dimensions	volume	color	pack quantity
095.06.001	18,5 x 66 mm	12,0 ml	clear	100 pieces
095.06.002	18,5 x 66 mm	12,0 ml	amber	100 pieces

CAPS & SEPTAS



► Offer optimum system performance. Designed to work excellently with needles. All of them are specially sized for proper sealings.

► Packed in tamper-proof evident, transparent, zip-locked bags that allow easy identification.

catalogue number	product specifications	pack quantity
095.06.003	white septum / beige PTFE - without hole	100 pieces





VIALS - "glass" - "screw cap" - "N20"

- Manufactured from hydrolic No:1 glass. Supplied without caps & septas.
- Offers perfect shape, very low dimensional tolerance and exact wall thickness for optimum performance.

catalogue number	vial dimensions	volume	color	pack quantity
095.03.001	22,7 x 86,0 mm	22,0 ml	clear	100 pieces
095.03.002	22,7 x 86,0 mm	22,0 ml	amber	100 pieces

CAPS & SEPTAS - "for N20 vials"



- Offer optimum system performance. Designed to work excellently with needles. All of them are specially sized for proper sealings.
- Packed in tamper-proof evident, transparent, zip-locked bags that allow easy identification.

catalogue number	product specifications	pack quantity
096.05.001	silicone / PTFE - without hole	100 pieces



VIALS - "glass" - "crimp cap" - "N20"

- Manufactured from hydrolic No:1 glass. Supplied without caps & septas.
- Offers perfect shape, very low dimensional tolerance and exact wall thickness for optimum performance.

catalogue number	vial dimensions	volume	color	pack quantity
095.03.003	20,5 x 54,5 mm	10,0 ml	clear	100 pieces
095.03.004	20,5 x 54,5 mm	10,0 ml	amber	100 pieces
097.03.001	22,5 x 46,0 mm	10,0 ml	clear	100 pieces
097.03.002	22,5 x 46,0 mm	10,0 ml	amber	100 pieces
097.04.001	22,5 x 75,5 mm	20,0 ml	clear	100 pieces
097.04.002	22,5 x 75,5 mm	20,0 ml	amber	100 pieces

CAPS & SEPTAS - "for N20 crimp vials"



- Offer optimum system performance. Designed to work excellently with needles. All of them are specially sized for proper sealings.
- Packed in tamper-proof evident, transparent, zip-locked bags that allow easy identification.

catalogue number	product specifications	pack quantity
096.03.001	silicone / PTFE - without slit	100 pieces



VIALS - "glass" - "screw cap" - "N24"

- ▶ Manufactured from hydrolic No:1 glass. Supplied without caps & septas.
- ▶ Offers perfect shape, very low dimensional tolerance and exact wall thickness for optimum performance.

catalogue number	vial dimensions	volume	color	pack quantity
095.03.011	27,5 x 95,0 mm	40,0 ml	clear	100 pieces
095.03.012	27,5 x 95,0 mm	40,0 ml	amber	100 pieces

CAPS & SEPTAS - "for N24 vials"



- ▶ Designed to work excellently with needles. Specially sized for proper sealings. Packed in tamper-proof evident, transparent, zip-locked bags that allow easy identification of interior.

catalogue number	product specifications	pack quantity
096.05.011	silicone / PTFE - without hole	100 pieces
096.05.012	silicone / PTFE - with hole	100 pieces



Offers adjustable crimping pressure by an easily accessible and well visible knob on the crimping head.

CRIMPERS & DECAPPERS - "manual"

- ▶ Manual crimpers and decappers are much lighter than the standard alternatives. They never create fatigue after long extended working periods.
- ▶ Ergonomical design offers improved comfort over blocky metal grips.
- ▶ Offers adjustable crimping pressure by a easily accessible and well visible knob on the crimping head.
- ▶ Activated by bottom handle motion guarantees faster and safer hold of the tool during crimping.
- ▶ Due to the design of the crimper head better vertical clearance over the vial is assured.



Bottom pull handle design for faster and safer hold of the tool during crimping and decapping.

catalogue number	product descriptions	pack quantity
097.01.011	crimper - for N 11 caps	1 piece
097.01.020	crimper - for N 20 caps	1 piece
097.02.011	decapper - for N 11 caps	1 piece
097.02.020	decapper - for N 20 caps	1 piece

RACKS / WORKSTATIONS "for vial"

- Manufactured from polycarbonate with high mechanical strength.
- Uniquely designed to carry 50 pieces of 2,0 ml & 5,0 ml volume vials in 10 x 5 array.
- Optimum design of the wells keeps the vials at their positions firmly and vertical.
- Alphanumerical index on vial rows enables easy identification of vial positions.
- Featured with a frosted write on and labelling area at the front side of the workstation.

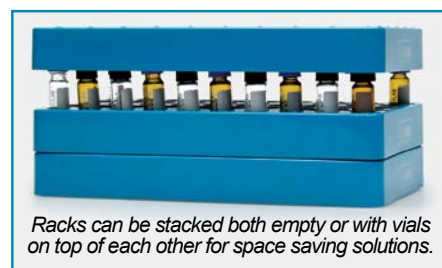

Racks can be stacked both empty or with vials on top of each other for space saving solutions.



catalogue number	for vials diameter	well quantity	vial array	L x W x H	rack color	pack quantity
095.95.001	11,60 mm	50	5 x 10	110x195x22 mm	blue	1 piece
095.95.002	14,75 mm	50	5 x 10	115x240x30 mm	dark blue	1 piece

TUBE BOX - "100 well" - "hinged lid"

- Manufactured from autoclavable polypropylene with high mechanical strength. Guarantees high temperature resistance between -20°C to +121°C.
- Uniquely designed to carry 100 vials with 11,0 - 12,0 mm diameter in 10 x 10 array. Easily stackable for reducing storage space.
- Hinged lid with built-in stop allows easy one-handed operation and access to vials.
- Clear box lid enables easy identification of box content and protects the vials from dust and other environmental effects.
- Different color options offer visual sorting and organising of different vials.
- Alphanumerical index both on tube rows and the lid enables easy identification of tube positions.



catalogue number	lid type	for vials diameter	well quantity	vial array	L x W x H	rack color	pack quantity
080.01.002B	hinged	11,6 mm	100	10 x 10	141x151x53 mm	blue	1 piece
080.01.002P	hinged	11,6 mm	100	10 x 10	141x151x53 mm	purple	1 piece
080.01.002R	hinged	11,6 mm	100	10 x 10	141x151x53 mm	ruby	1 piece



Clear box lid provides protection of vials from environmental effects.



Alphanumerical index enables easy identification of vial positions.



Different colors offer visual sorting and organising of different samples.



Corner frames enable perfect stacking on each other without sliding.



CUVETTES - "polystyrene" - "12,5 x 12,5 x 45 mm"

- Manufactured from glass-clear polystyrene with 12,5 x 12,5 x 45 mm overall dimensions as single use.
- Can be both used for chemistry and life science applications.
- Wavelength operating range from 340 to 900 nm. Offers a light path of 10 mm with clear and clean optical path length.
- Optimised shape and narrow wall thickness provide increased heat transfer resulting in more constant sample temperatures during measurements.
- Grouped by mould cavity and packed in same box to ensure lowest variation of absorption coefficient.
- Eliminates cross contamination risk associated with washing and re-using such as glass cuvettes.
- Available 2 cuvettes:
 - Macro cuvettes
 - Semi-micro cuvettes
- Supplied as 100 cuvettes packed in a styrofoam box with a cover.

catalogue number	cuvette type	product descriptions	material	wavelength range	light path	volume	internal width	pack quantity
098.02.002	macro	with clear wall & without cap	polystyrene	340 - 900 nm	10 mm	2,5-4,5 ml	10 mm	100 pieces
098.02.001	semi-micro	with clear wall & without cap	polystyrene	340 - 900 nm	10 mm	1,5-3,0 ml	4 mm	100 pieces



CUVETTES - "glass" - "12,5 x 12,5 x 45 mm"

- Manufactured from polished quartz glass or polished optical glass with 12,5 x 12,5 x 45 mm dimensions as multi-use.
- They offer clear and clean optical path length and fit to all standard spectrophotometer cuvette holders.
- Can be both used for chemistry and life science applications.
- Quartz cuvettes provide wavelength operating range from 190 to 2.500 nm.
- Optical glass cuvettes provide wavelength operating range from 340 to 2.500 nm.
- Optimised shape, precise dimensions with tolerance less than 0,1 % mm and excellent wall thickness provide accurate results during measurements.
- Available 3 cuvettes:
 - Macro cuvettes
 - Semi-micro cuvettes
 - Micro cuvettes
- Supplied as 2 cuvettes packed in a polystyrene box for protection from dust and other environmental effects.

catalogue number	cuvette type	product descriptions	material	wavelength range	light path	volume	internal width	pack quantity
098.01.001	macro	with clear wall & PTFE cap	ES Quartz	190 - 2500 nm	10 mm	3,50 ml	10 mm	2 pieces
098.01.002	semi-micro	with frosted wall & PTFE cap	ES Quartz	190 - 2500 nm	10 mm	1,40 ml	4 mm	2 pieces
098.01.003	micro	with frosted wall & PTFE cap	ES Quartz	190 - 2500 nm	10 mm	0,70 ml	2 mm	2 pieces
098.01.004	macro	with clear wall & PTFE cap	optical glass	340 - 2500 nm	10 mm	3,50 ml	10 mm	2 pieces
098.01.005	semi-micro	with frosted wall & PTFE cap	optical glass	340 - 2500 nm	10 mm	1,40 ml	4 mm	2 pieces
098.01.006	micro	with frosted wall & PTFE cap	optical glass	340 - 2500 nm	10 mm	0,70 ml	2 mm	2 pieces

CUVETTES - "glass" - "12,5 x 52,5 x 45 mm"

- Manufactured from polished quartz glass or polished optical glass with 12,5 x 52,5 x 45 mm dimensions as multi-use for chemistry and life science applications.
- They offer clear and clean optical path length and fit to all standard spectrophotometer cuvette holders.
- Quartz cuvettes provide wavelength operating range from 190 to 2.500 nm.
- Optical glass cuvettes provide wavelength operating range from 340 to 2.500 nm.
- Optimised shape, precise dimensions with tolerance less than 0,1 % mm and excellent wall thickness provide accurate resulting during measurements.
 - **Macro cuvettes**
 - **Available 3 cuvettes:**
 - **Semi-micro cuvettes**
 - **Micro cuvettes**
- Supplied as 2 cuvettes packed in a polystyrene box for protection from dust and other environmental effects.



catalogue number	cuvette type	product descriptions	material	wavelength range	light path	volume	internal width	pack quantity
098.01.007	macro	with clear wall & PTFE cap	ES Quartz	190 - 2500 nm	50 mm	17,5 ml	10 mm	1 piece
098.01.008	semi-micro	with frosted wall & PTFE cap	ES Quartz	190 - 2500 nm	50 mm	7,00 ml	4 mm	2 pieces
098.01.009	micro	with frosted wall & PTFE cap	ES Quartz	190 - 2500 nm	50 mm	3,50 ml	2 mm	2 pieces
098.01.010	macro	with clear wall & PTFE cap	optical glass	340 - 2500 nm	50 mm	17,5 ml	10 mm	1 piece
098.01.011	semi-micro	with frosted wall & PTFE cap	optical glass	340 - 2500 nm	50 mm	7,00 ml	4 mm	2 pieces
098.01.012	micro	with frosted wall & PTFE cap	optical glass	340 - 2500 nm	50 mm	3,50 ml	2 mm	2 pieces

BOX - "for cuvettes"

- Manufactured from polypropylene with 120x112x60 mm dimensions for safe handling and holding 12 cuvettes with 10 mm width.
- Hinged lid secures clasps and offers convenient use of the box. Removable cuvette insert helps easy cleaning.
- The inside height designed to accommodate all cuvettes.

catalogue number	box color	pack quantity
098.03.001B	blue	1 piece
098.03.001P	purple	1 piece
098.03.001R	ruby	1 piece



RACK - "for cuvettes"

- Manufactured from polypropylene with 210x70x35 mm dimensions for safe handling and holding 16 cuvettes with 10 mm width.
- Alphanumeric index on cuvette rows enables easy identification of tube positions.
- 2 tier body form offers clear visibility option from horizontal direction.

catalogue number	box color	pack quantity
098.03.002B	blue	1 piece
098.03.002P	purple	1 piece
098.03.002R	ruby	1 piece



TLC SEPARATION TANK

- Rectangular shaped TLC developing tanks are used to develop 20x20 cm TLC plates.
- TLC developing tanks are used to run up to 5 TLC plates for separation. It is important to maintain saturated conditions during the analysis which can be achieved by using small tanks, filter paper liners and sufficient solvents.
- The tank can be equilibrated for 30 minutes prior to running the plate to yield good result.
- TLC Developing tank supplied to gather with the lid.

catalogue number	pack quantity
108.01.016	1 piece



TLC SPRAY KIT



- Offers an economical solution for TLC spraying. Provides a fine uniform spray ideally adjusted for TLC practices.
- Supplied complete with 100 ml erlenmeyer with sprayer head and a rubber pressure bellow.

catalogue number	pack quantity
108.02.002	1 piece

TLC SPRAYER - "with gas canister"

- TLC sprayer provide a fine, uniform spray all over the TLC plate surfaces for optimization of TLC plates.
- With it's unique design offer easy-to-use and easy-to-clean options.
- Based on a simple technology where the aerosol canister is situated above the reservoir bottle.
- A small press of the lever highly pressurises the lower glass reservoir bottle releasing a fine mist of spray.
- Propellant mixture is eco-friendly and does not harms the nature.
- Guarantees homogenous distribution, even coverage and minimum reagent consumption.
- Gas canister serves as handle. Cap fits to all 38 - 40 thread reagent bottles.

catalogue number	pack quantity
108.02.001	1 piece

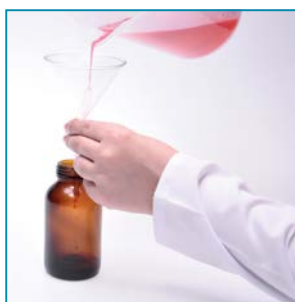

Filling: Pour the TLC reagent into the bottle. Never fill above the shoulder line.

Mounting: Attach TLC sprayer to the bottle by turning anti-clockwise. Never shake the sprayer during mounting.

Spraying: Start spraying with the sprayer and release the button while the sprayer is still moving at the end of the TLC plate to avoid reagent loss. For best performance a spraying angle between 90° and 45° is required.

Also always hold the sprayer at a distance between 15 cm to 30 cm from TLC plate surface.



ISOLAB

Laborgeräte GmbH



*life sciences
microscopy
microbiology*

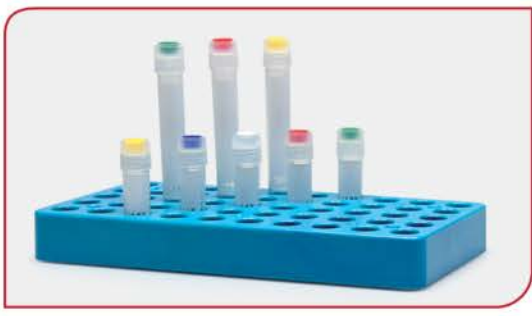
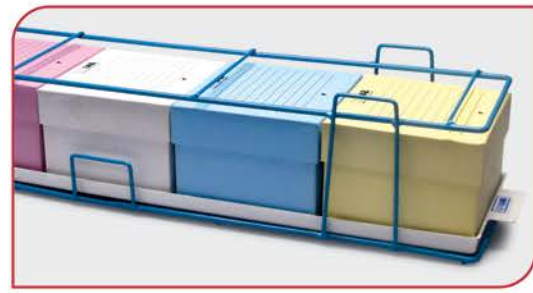



TUBES - "centrifuge" "conical bottom" - "screw cap"

- Manufactured from ultra clear, high grade polypropylene.
- Ultra rugged tube wall guarantees resistance to high centrifugal forces up to 6.000 RCF.
- Autoclavable at 121°C for 20 minutes. Caps should not be kept closed during autoclaving process.
 - **non-sterilized**
 - **Alternative 3 tubes:**
 - **aseptic tubes**
 - **sterile tubes**
- Aseptic tubes are manufactured in germ-free, class 10.000 sterile areas.
- Sterile tubes are manufactured in germ-free, class 10.000 sterile production areas and then re-sterilised by gamma irradiation.
- Sterile tubes are supplied with a certificate as a guarantee of "DNase, RNase & pyrogen free" product.
- Caps are manufactured from polyethylene with large ridges for increased grip for easy opening and closing.



Individually single packed sterile tubes have printed lot number, production date and expiry date on the package.



Sterile tubes are supplied with a certificate as a guarantee of "DNase, RNase & pyrogen free" criterias and guarantees the documentation of the quality.

- Cap inner design ensures hermetical and leak-proof closure. Caps can be opened and closed with single hand. A 3/4 turn of the cap will be sufficient for full closure.

- Graduations on side wall offer visual control of the filled volume. Printed marking area on side wall enables easy marking and labelling.

- Flat cap top provides multiple options for marking and labelling of the tube.

- Precise volume marks at the tube bottom clearly and visually show the liquid volume at the tube bottom.



Precise volume marks at the tube bottom clearly and visually show the liquid volume at the tube bottom.



Unique cap design with large ridges enables single hand operation. A 3/4 turn of the cap will be sufficient for hermetical and leak-proof closure of the tube.



Printed marking area on side wall enables easy marking and labelling. Clear graduations for easy volume reference.

clear tubes	amber tubes	volume	tube dimensions	product specifications	packing specifications	pack quantity	box quantity
078.02.001	078.12.001	15 ml	17 x 120 mm	non sterilized	pack in bag	50 pieces	500 pieces
078.02.003	078.12.003	50 ml	30 x 120 mm	non sterilized	pack in bag	50 pieces	500 pieces
078.02.007	078.12.007	15 ml	17 x 120 mm	sterilized - aseptic	pack in bag	50 pieces	500 pieces
078.02.008	078.12.008	50 ml	30 x 120 mm	sterilized - aseptic	pack in bag	50 pieces	500 pieces
078.02.002	078.12.002	15 ml	17 x 120 mm	gamma sterilized - DNA & RNA free	single flow pack	50 pieces	500 pieces
078.02.004	078.12.004	50 ml	30 x 120 mm	gamma sterilized - DNA & RNA free	single flow pack	50 pieces	500 pieces



TUBES - "centrifuge" "self standing" - "screw cap"

- Manufactured from ultra clear, high grade polypropylene. Self stands on the laboratory benches without the need of any tube support.
- Ultra rugged tube wall guarantees resistance to high centrifugal forces up to 6.000 RCF.
- Autoclavable at 121°C for 20 minutes. Caps should not be kept closed during autoclaving process.
- **Alternative 3 tubes:**
 - non-sterilized
 - aseptic tubes
 - sterile tubes
- Aseptic tubes are manufactured in germ-free, class 10.000 sterile areas.
- Sterile tubes are manufactured in germ-free, class 10.000 sterile production areas and then re-sterilised by gamma irradiation.
- Sterile tubes are supplied with a certificate as a guarantee of "DNase, RNase & pyrogen free" product.
- Caps are manufactured from polyethylene with large ridges for increased grip for easy opening and closing. Other technical specifications are exactly similar to the conical bottom.



clear tubes	amber tubes	volume	tube dimensions	product specifications	packing specifications	pack quantity	box quantity
078.02.005	078.12.005	50 ml	30 x 120 mm	non sterilized	pack in bag	50 pieces	500 pieces
078.02.009	078.12.009	50 ml	30 x 120 mm	sterilized - aseptic	pack in bag	50 pieces	500 pieces
078.02.006	078.12.006	50 ml	30 x 120 mm	gamma sterilized - DNA & RNA free	single flow pack	50 pieces	500 pieces

TUBE RACKS - "for 15 & 50 ml conical bottom centrifuge tubes" - "push & hold"

- Manufactured from high grade polypropylene for safe holding and carrying conical bottom centrifuge tubes.
- Resistant to most acids, bases, and many commonly used solvents. Guarantees high temperature resistance between -20°C to +121°C.
- Uniquely designed to carry 25 tubes in 5 x 5 array tube compartments for holding the tubes in their position firmly.
- Very easy to use; Just press the tubes slightly into the tube compartments and leave.
- Different color options offer visual sorting and organising of different samples.
- Empty racks are easily stackable for reducing storage space.
- Alphanumerical index on tube rows enables easy identification of tube positions.

catalogue number	for tubes	well quantity	tube array	L x W x H	pack quantity
078.06.015B	15 ml	25	5 x 5	120x150x32 mm	1 piece
078.06.050B	50 ml	25	5 x 5	190x230x35 mm	1 piece



Designed to carry 25 tubes in 5 x 5 array tube compartments.





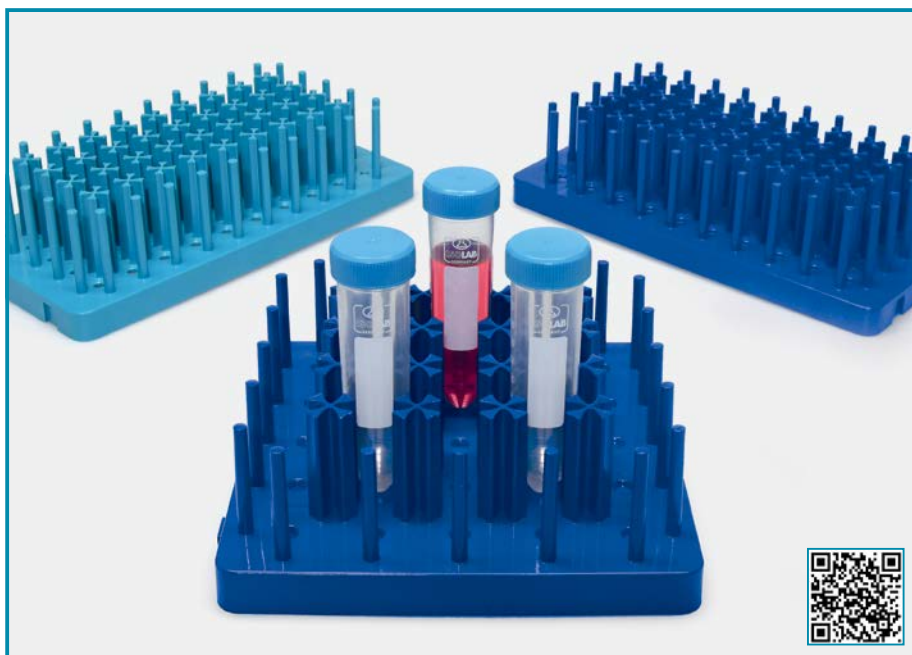

Unique designed tube compartments hold the tube in their position firmly.

TUBE RACKS - "for 15 & 50 ml conical bottom centrifuge tubes" - "hedgehog design"



- Manufactured from "modified" high quality ABS which enables the rack to be used in water baths without the risk of floating.
- Resistant to most acids, bases, and many commonly used solvents.
- "Hedgehog" designed cross formed tube support rods enable uniform aligning of tubes in their position firmly.
- Unique rack design allows easy viewing of the tube contents in 4 angles.
- Different color options offer visual sorting and organising of different samples.
- The interlocking design of the racks makes them ideal for creating a user friendly workstation.
- These racks can also be used as drying rack for tubes and chromatography plates.

catalogue number	for tubes	well quantity	tube array	L x W x H	rack color	pack quantity
079.08.015B	15 ml	50	5 x 10	140x270x66 mm	blue 	1 piece
079.08.015L	15 ml	50	5 x 10	140x270x66 mm	dark blue 	1 piece
079.08.050B	50 ml	25	5 x 5	200x200x70 mm	blue 	1 piece
079.08.050L	50 ml	25	5 x 5	200x200x70 mm	dark blue 	1 piece

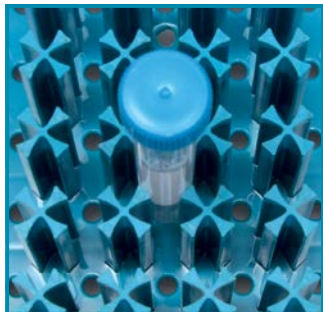

"Hedgehog" designed cross formed tube supports enable uniform aligning of tubes in positions firmly.

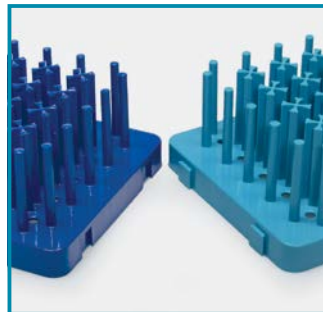

The interlocking design of the racks makes them ideal for creating a user friendly workstation.



Different color options offer visual sorting and organising of different samples.

TUBE BOX - "for 15 & 50 ml conical bottom centrifuge tubes" - "cardboard"



- Manufactured from freeze resistant, water repellent, durable cardboard covered with superior quality chromated paper coating.
- Press on lids perfectly fit to the box body provides a safe and tight closure. Protects the box interior from dust, moisture and other environmental effects.
- Special moisture repellent coating protects box interior from the effects of liquid nitrogen or condensation from refrigerators.
- Sized to fit all standard steel and polycarbonate freezer racks
- Chemically resistant to alcohols and mild organic solvents. Offers temperature resistance between -196°C to +121°C.
- Alphanumeric index on the lid for identification of tube positions.
- Write on area at the side wall and the lid provides a convenient area for special notes.

catalogue number	for tubes	well quantity	tube array	L x W x H	pack quantity
078.20.015W	15 ml	36	6 x 6	130x130x125 mm	1 piece
078.20.050W	50 ml	16	4 x 4	150x150x125 mm	1 piece



TUBE RACKS - "foldable"

- Manufactured from modified polypropylene which enables the racks to be used in water baths without floating.
- Resistant to most acids, bases, and many commonly used solvents. Guarantees high temperature resistance between -20°C to +121°C.
- Raised tube sockets guarantee firm hold of the tubes at their exact positions.
- The alpha numeric grid reference on the top tier of the rack ensures an easy tube location and sample positioning.
- Racks are supplied assembled and folded. Can be ready for use in few seconds with a simple action.
- These racks can be refolded after use for reducing storage area.

catalogue number	tube volume	tube quantity	tube array	pack quantity
079.03.003B	15 ml	50	5 x 10	1 piece
079.03.005B	50 ml	26	4 x 6/7	1 piece
079.03.006B	15 & 50 ml	21 & 12	assorted	1 piece



Raised tube supports strongly hold the tubes in their position.

Tube rack can be folded for space saving solution.

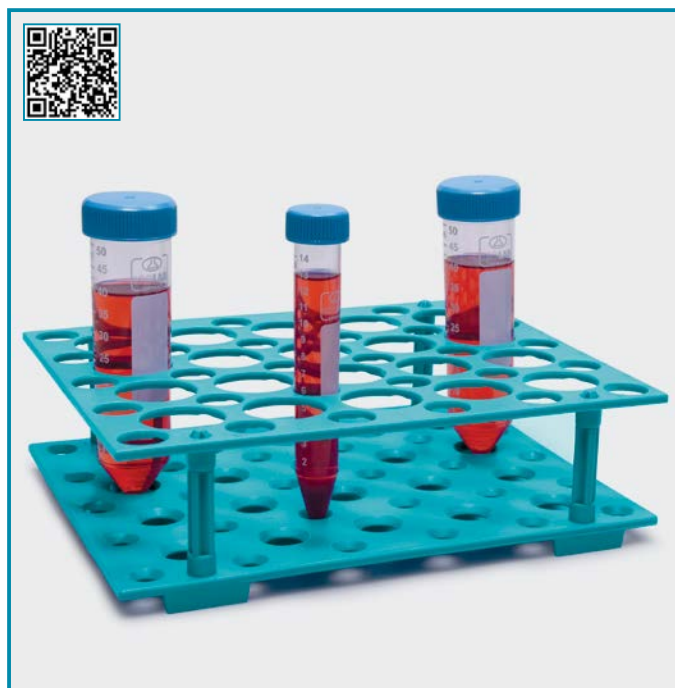
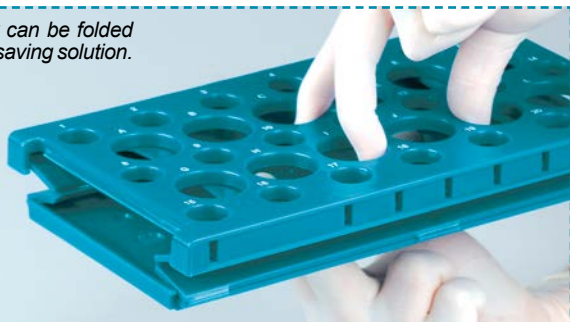

TUBE RACK - "snapable"

- Manufactured from high grade ABS for safe holding and carrying conical bottom centrifuge tubes.
- Uniquely designed to carry 30 x 15 ml and 20 x 50 ml centrifuge tubes simultaneously.
- Rack is supplied already disassembled. Unique and practical "snapping" system allows the rack "ready to use" in few seconds.
- Alphanumerical index on the lid enables easy identification of tube positions.

catalogue number	tube volume	tube quantity	tube array	pack quantity
079.04.001	15 & 50 ml	30 & 20	assorted	1 piece

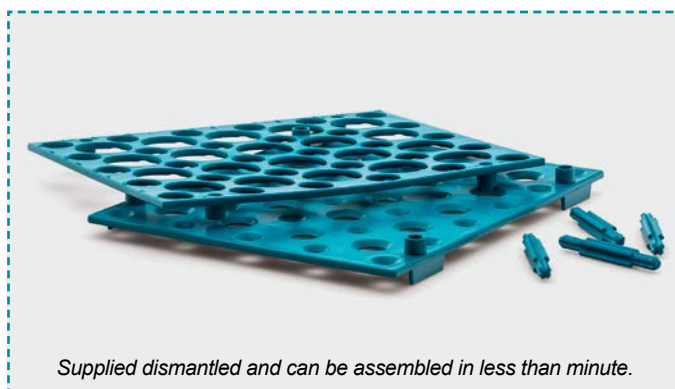

Supplied dismantled and can be assembled in less than minute.



Holes at the bottom plate guarantee firm hold of tubes in their position.

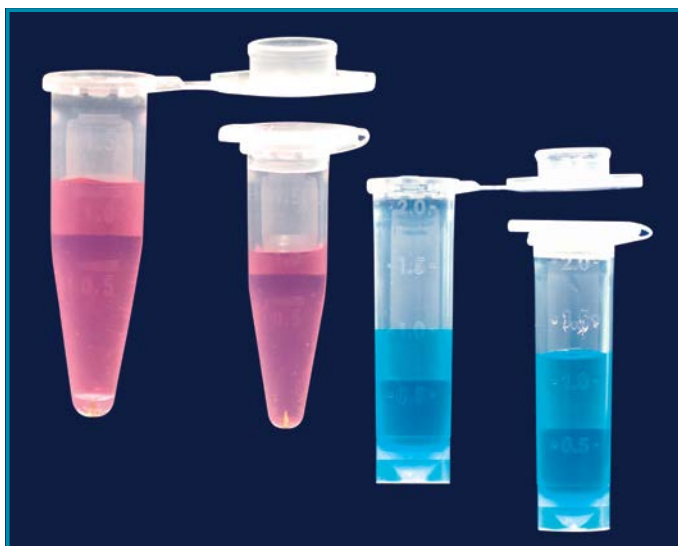

CENTRIFUGE TUBES - "micro" - "with flat cap"

➤ Manufactured from ultra clear polypropylene with flat caps that ensure smooth opening and closing with one hand. Once closed they guarantee leak-proof closure

➤ **Conical bottom tubes which need a tube rack**

➤ **Alternative 2 shapes:**

➤ **Skirted tubes which can self stand on benches.**

➤ Skirted tubes can self stand on laboratory benches without the need of any tube rack.

➤ Ultra rugged tube wall guarantees resistance to high centrifugal forces up to 20.000 RCF. Optimum tube design offers micro pestle compatibility.

➤ Reinforced tube bottom ensures added protection against deformation and leakage. Conical bottom form guarantees excellent fit to almost all centrifuge rotors. Highly polished interior wall guarantees low liquid retention and ensures minimum sample loss.

➤ Autoclavable at 121°C for 20 minutes. Caps should not be kept closed during autoclaving process. Otherwise tubes can be deformed.

➤ **Alternative 2 tubes:** ➤ **aseptic tubes**
➤ **gamma sterile tubes**

➤ Aseptic tubes are manufactured in germ-free, class 10.000 sterile production areas with extreme sterility control.

➤ Sterile tubes are manufactured in germ-free, class 10.000 sterile production areas and then resterilised by gamma irradiation. Supplied with a certificate as a guarantee of "DNase, RNase & pyrogen free" product.

➤ Improved cap design ensures smooth opening and closing with one hand. Inner design ensures hermetical and leak-proof closure. Cap can be pierced easily with any syringe needle.

➤ Graduations on the side wall offer visual control of the filled volume. Frosted marking area on side wall enables easy marking and labelling.

tubes sterilized	tubes non sterilized	volume	skirt	pack quantity	box quantity
078.03.021	078.03.001	0.5 ml	non	500 pieces	5000 pieces
078.03.022	078.03.002	1.5 ml	non	500 pieces	5000 pieces
078.03.023	078.03.003	2.0 ml	non	500 pieces	5000 pieces
078.03.024	078.03.004	2.0 ml	yes	500 pieces	5000 pieces



CENTRIFUGE TUBES - "micro" - "with safe-lock cap"

➤ Manufactured from ultra clear polypropylene with safe lock caps that ensure smooth opening and closing with one hand.

➤ Once closed they guarantee leak-proof closure.

➤ Safe-lock caps have a small clasp that clips onto the rim of the tube preventing accidental openings specially during applications where heating is required.

➤ **Alternative 2 tubes:** ➤ **aseptic tubes**
➤ **gamma sterile tubes**

➤ All other technical specifications are identical with flat cap tubes.

tubes sterilized	tubes non sterilized	volume	pack quantity	box quantity
078.05.022	078.05.002	1.5 ml	500 pieces	5000 pieces
078.05.025	078.05.005	5.0 ml	200 pieces	2000 pieces

TUBE ADAPTER - "for 5 ml microtubes"



➤ Manufactured from polypropylene.

➤ Perfectly fits to the bottom part of the 15 ml centrifuge tube rotors.

➤ They provide the practical usage of the 5 ml tube in a 15 ml rotor.

catalogue number	pack quantity
078.05.105	8 pieces

CRYO TUBES - "sterile"

- Designed for the storage and conservation of biological material, human and animal cells at very low temperatures in the gas phase of liquid nitrogen or in cryogenic freezers.
- Manufactured from ultra clear, polypropylene by fully automatic machines. Highly polished interior wall guarantees low liquid retention and ensures minimum sample loss.
- Cryo tubes are manufactured in germ-free, class 10.000 sterile production areas and then resterilised by gamma irradiation.
- Tubes are supplied with a certificate as a guarantee of "DNase, RNase & pyrogen free" product.
- Since both cap and tube are made of same material with same coefficient of expansion secure seal at all temperatures.
- Caps are featured with cavities for different colored cap inserts which enable easy identification of tube contents. Cap inner design ensures hermetical and leak-proof closure
- Silicone washer inside the cap ensures positive sealing at any temperature and prevents leakage.
- Caps can be opened and closed with single hand. A 3/4 turn of the cap will be sufficient for full closure.
- Unique foot design enables free standing option. Foot design allows the tube to be fixed at the cryo vial racks. Tube caps can be opened by single hand.

cryo tubes with external thread	tube volume	tube height	tube diameter	pack quantity
091.11.102	2.0 ml	48,6 mm	12,4 mm	100 pieces
091.11.105	5.0 ml	90,4 mm	12,4 mm	100 pieces



Unique star-base foot design enables free standing option.

Base design allows the tube to be fixed at the cryo vial racks. Tube caps can be opened by single hand without the need of picking up the tubes.



Silicone washer ensures positive sealing and prevents leakage.



Graduations on the side wall offer visual control of the filled volume.

CRYO TUBE CANES - "polycarbonate"



➤ Made from polycarbonate for holding cryo tubes. Ideal tool to insert the cryo tubes into cryo freezer storage or into dewar flasks. With their total length of 310 mm they can carry 6 pieces 2,0 ml and 3 pieces 5,0 ml cryo tubes at a row.

catalogue number	pack quantity
092.35.003	12 pieces

CAP INSERTS

- Caps are featured with cavities for different colored cap inserts. Cap inserts are made from P.P with different colors for easy identification of tubes.
- They fit precisely into the caps by slight pressing. They can be easily dismantled.

catalogue number	cap inserts disc color	pack quantity
091.15.001	white	100 pieces
091.15.002	blue	100 pieces
091.15.003	yellow	100 pieces
091.15.004	red	100 pieces
091.15.005	green	100 pieces



MICROTUBE RACKS "foldable"

➤ Manufactured from polypropylene with high mechanical strength.

➤ Resistant to most acids, bases and solvents. Guarantees high temperature resistance between -20°C to +121°C.

➤ Alphanumerical index on tube rows enables easy identification of tube positions. Marking areas on wall sides enable easy marking and labelling.

➤ Supplied dismantled as a sheet and can easily be assembled in few seconds.

➤ Also can be dismantled in few seconds and forms a flat layer for safe and efficient storage purpose.

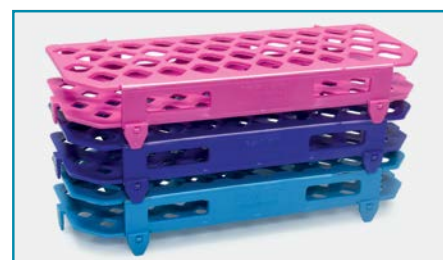

Different color options offer visual sorting and organising of different samples. After replacement of the tubes racks can be stacked on top of each other for space saving.



Supplied dismantled as a sheet and can easily be assembled in few seconds.

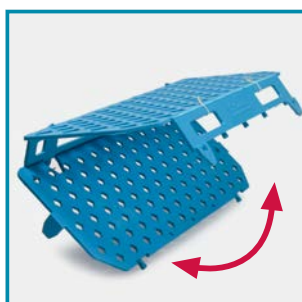

Also can be dismantled in few seconds and forms a flat layer for safe and efficient storage purpose.

racks for 1,5 & 2,0 ml	well quantity	racks for 5,0 ml	well quantity	rack L x W x H	rack color	pack quantity
080.01.005B	100	080.01.006B	42	110x260x45 mm	blue	1 piece
080.01.005P	100	080.01.006P	42	110x260x45 mm	purple	1 piece
080.01.005R	100	080.01.006R	42	110x260x45 mm	ruby	1 piece

MICROTUBE RACKS "foldable"

➤ Manufactured from polypropylene with high mechanical strength.

➤ Resistant to most acids, bases and solvents. Guarantees high temperature resistance between -20°C to +121°C.

➤ Can be used with a unique base support tray that provides alternative inclined position for the rack.

➤ According to the wish rack can be used horizontally or with 30 degree angle providing easy filling option of the tubes.

➤ After replacement of the tubes racks can be stacked on top of each other for space saving solution.

➤ Alphanumerical index on tube rows enables easy identification of tube positions.

➤ Marking areas on wall sides enable easy marking and labelling.



catalogue number	for tubes	well quantity	tube array	rack L x W x H	rack color	pack quantity
080.01.004B	1,5 / 2,0 ml	96	8 x 12	205x135x55 mm	blue	1 piece
080.01.004P	1,5 / 2,0 ml	96	8 x 12	205x135x55 mm	purple	1 piece
080.01.004R	1,5 / 2,0 ml	96	8 x 12	205x135x55 mm	ruby	1 piece
080.01.007B	5,0 ml	48	6 x 8	205x135x70 mm	blue	1 piece
080.01.007P	5,0 ml	48	6 x 8	205x135x70 mm	purple	1 piece
080.01.007R	5,0 ml	48	6 x 8	205x135x70 mm	ruby	1 piece

BASE SUPPORT

➤ Base support is manufactured from acrylic with 30° inclination. When placed under the tube rack with the help of 30 degree inclination this support offers easy filling options of the tubes specially when you are sitting.

catalogue number	color	pack quantity
080.01.101	white	1 piece







MICROTUBE RACKS

"3 tier"

- Manufactured from polypropylene with high mechanical strength.
- Resistant to most acids, bases and solvents. Guarantees high temperature resistance between -20°C to $+121^{\circ}\text{C}$.
- The interlocking design of the racks makes them ideal for creating a workstation.
- Raised tube slots guarantee firm and stable hold of tubes in vertical position.
- Alphanumerical index on tube rows enables easy identification of tube positions. Marking areas on wall sides enable easy marking and labelling.

➤ Unique design for to carry 3 different size micro tubes on each tier:

- Bottom row carries 24 x 0,2 ml (2 x 12 array) micro tubes.
- Middle row carries 14 x 0,5 ml (2 x 7 array) micro tubes.
- Upper row carries 12 x 1,5 ml (2 x 6 array) micro tubes.

catalogue number	rack dimensions	rack color	pack quantity
080.01.003B	165x125x60 mm	blue 	1 piece
080.01.003P	165x125x60 mm	purple 	1 piece
080.01.003R	165x125x60 mm	ruby 	1 piece

Different color options offer visual sorting and organising of different samples



MICROTUBE RACKS

"double side"

- Manufactured from polypropylene with high mechanical strength.
- Resistant to most acids, bases and solvents. Guarantees high temperature resistance between -20°C to $+121^{\circ}\text{C}$.
- Rack has two sides and each side accommodates different size and combination of microcentrifuge tubes.
- Clear box lid enables easy identification of rack content and protects the tubes from dust, moisture and other effects.
- Alphanumerical index on tube rows enables easy identification of tube positions. Marking areas on wall sides enable easy marking and labelling.

➤ Different color options offer visual sorting and organising of different samples.



➤ Racks can be stacked on top of each other for space saving.

➤ Uniquely designed to carry different size micro tubes on both sides.

➤ **Upper side:** carries 96 x 1,5 ml (6x16 array) micro tubes

➤ **Reverse side:** carries 48x0,5 ml (6x8 array) and 96 x 0,2 ml (8x12 array) micro tubes.



catalogue number	dimensions	rack color	pack quantity
080.06.002B	290x110x60 mm	blue 	1 piece
080.06.002P	290x110x60 mm	purple 	1 piece
080.06.002R	290x110x60 mm	ruby 	1 piece

Racks can be stacked on top of each other for space saving.



CRYO TUBE WORK STATION - "50 well"

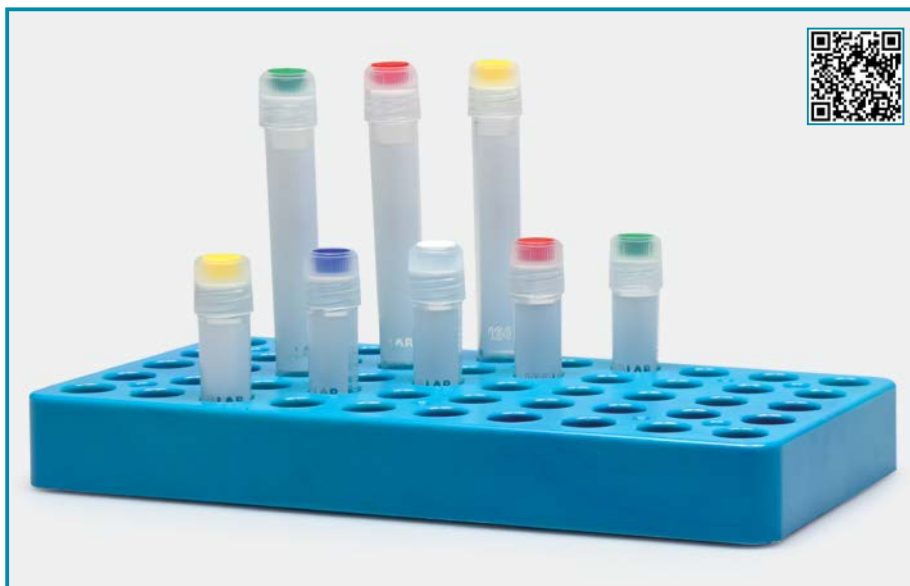

➤ Manufactured from polycarbonate with high mechanical strength.

➤ Resistant to most acids, bases and solvents. Guarantees high temperature resistance between -196°C to +121°C.

➤ Uniquely designed to carry 50 pieces of 2,0 ml & 5,0 ml volume cryo tubes in 10 x 5 array.

➤ These racks allow easy one handed opening and closing of tubes thanks to an innovative locking system.

➤ The locking system at the well bottoms ensures that tubes will securely lock in each position and will not return in their axis.

➤ Alphanumerical index on tube rows enables easy identification of tube positions.

➤ Featured with a frosted write on and labelling area at the front side.

➤ Different color options offer visual sorting and organising of different samples

catalogue number	for tubes	well quantity	tube array	L x W x H	rack color	pack quantity
092.01.001B	2,0 - 5,0 ml	50	10 x 5	195x101x24 mm	blue	1 piece
092.01.001P	2,0 - 5,0 ml	50	10 x 5	195x101x24 mm	purple	1 piece
092.01.001R	2,0 - 5,0 ml	50	10 x 5	195x101x24 mm	ruby	1 piece

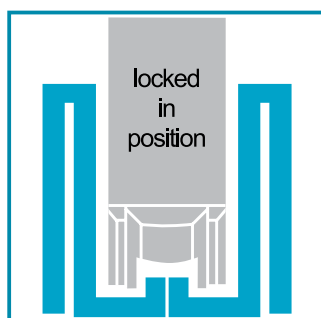

These racks allow easy one handed opening and closing of tubes thanks to an innovative locking system.

The locking system at the well bottoms ensures that tubes will securely lock in each position and will not return in their axis.

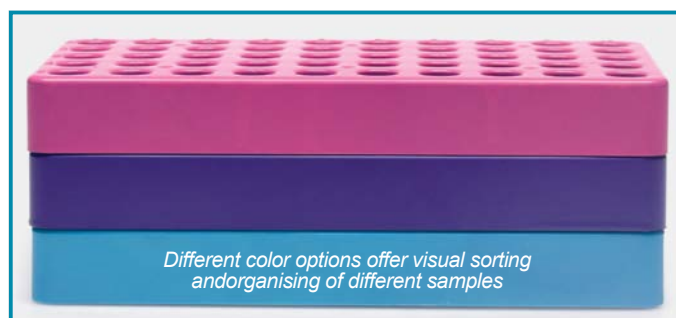

TUBE BOX - "100 well" - "hinged lid"

➤ Manufactured from polypropylene with high mechanical strength. Resistant to most acids, bases and solvents. Guarantees high temperature resistance between -20°C to +121°C.

➤ Uniquely designed to carry 100 cryo tubes in 10 x 10 array.

➤ Hinged lid with built-in stop allows easy one-handed access. Featured with a frosted write on area at the front side of the lid.

➤ Clear box lid enables easy identification of box content and protects the tubes from environmental effects.

➤ Moulded frames at the corners of the tube boxes enable perfect stacking on top each other without sliding.



catalogue number	tube array	L x W x H (mm)	rack color	pack quantity
080.01.002B	10 x 10	141x151x53	blue	1 piece
080.01.002P	10 x 10	141x151x53	purple	1 piece
080.01.002R	10 x 10	141x151x53	ruby	1 piece

Alphanumerical index both on tube rows and the lid enables easy identification of tube positions.

Different color options offer visual sorting and organising of different samples.

CRYO TUBE BOXES - "81 well" - "polycarbonate"

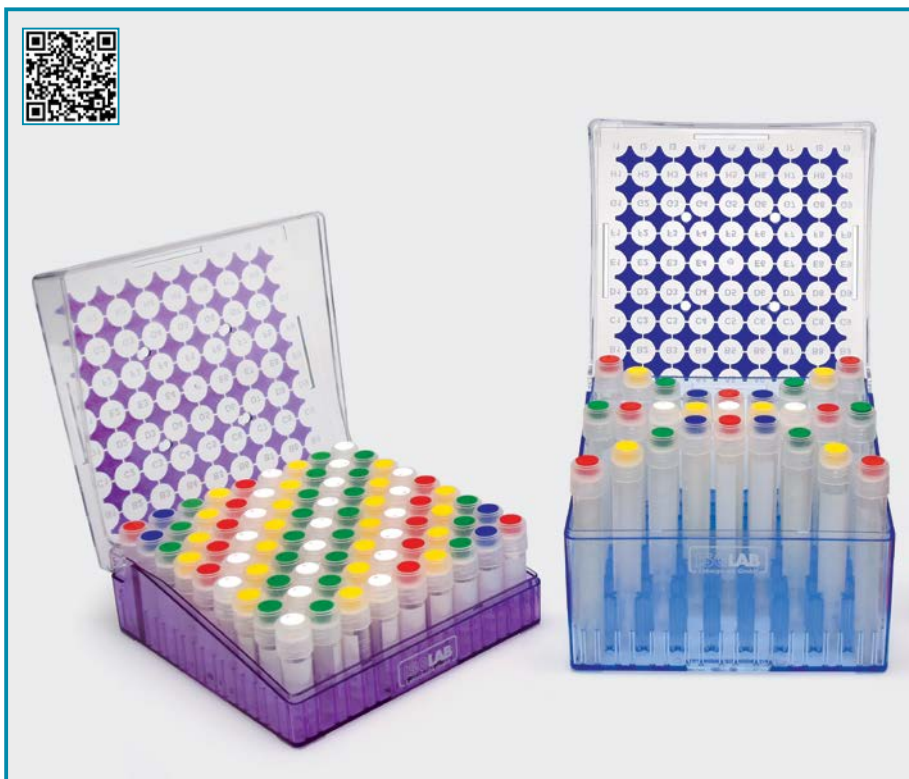

➤ Manufactured from polycarbonate with high mechanical strength and high temperature resistance between -196°C to $+121^{\circ}\text{C}$.

➤ Uniquely designed to carry 81 pieces micro or cryo tubes in 9 x 9 array.

➤ "Hedgehog" designed tube compartments hold the tube in their position firmly. They fit all steel and polycarbonate freezer racks.

➤ Unique design with vent and drainage holes guarantees best, efficient air circulation.

➤ Forward slope base ensures quick visual orientation. Easily stackable for reducing storage space.

➤ Hinged lid with built-in stop allows very easy access to tubes.

➤ Clear box lid enables easy identification of box content and protects the tubes from dust, moisture and other environmental effects.

➤ Vent and drainage holes at the lid and the base guarantee the best air circulation.

➤ Alphanumeric index both on tube rows and the lid enables easy identification of tube positions.

➤ Featured with a frosted write on area at the front side of the lid.

➤ Different color options offer visual sorting and organising of different samples.

catalogue number	for tubes	well quantity	tube array	L x W x H	box color	pack quantity
093.01.001G	2,0 ml	81	9 x 9	133x133x53 mm	green	1 piece
093.01.001P	2,0 ml	81	9 x 9	133x133x53 mm	purple	1 piece
093.01.001R	2,0 ml	81	9 x 9	133x133x53 mm	ruby	1 piece
093.01.002B	5,0 ml	81	9 x 9	133x133x96 mm	blue	1 piece

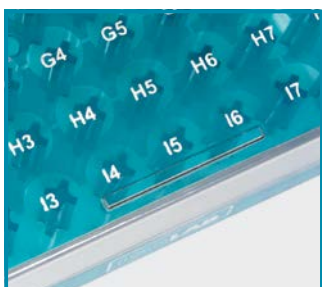

Vent and drainage holes at the lid and the base guarantee the best air circulation.



"Hedgehog" designed cross formed tube supports enable uniform aligning of tubes in positions firmly.

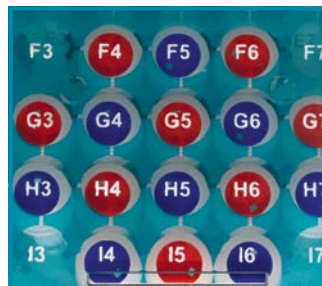

Alphanumeric index both on tube rows and the lid enables easy identification of tube positions.



Box is supplied together with a disposable forceps for easy removal of tubes.



CRYO TUBE BOXES - "81 well" - "cardboard"

➤ Manufactured from freeze resistant, water repellent, durable cardboard covered with superior quality chromated paper coating.

➤ Special moisture repellent coating protects box interior from the effects of liquid nitrogen or condensation from refrigerators.

➤ Chemically resistant to alcohols and mild organic solvents. Offers temperature resistance between -196°C to $+121^{\circ}\text{C}$.

➤ Alphanumeric index on the lid for identification of tube positions. Write on area at the side wall and the lid provides a convenient area for special notes.

➤ Press on lids perfectly fit to the box body provides a safe and tight closure. Protects the box interior from dust, moisture and other environmental effects.

➤ Sized to fit all standard steel and polycarbonate freezer racks

catalogue number	for tubes	well quantity	tube array	L x W x H	pack quantity
092.22.101W	2,0 ml	81	9 x 9	135x135x50 mm	1 piece
092.22.102W	5,0 ml	81	9 x 9	135x135x95 mm	1 piece



PCR TUBES - "single cavity"

- Single cavity 0.2 ml PCR tubes for thermal transfer and PCR applications are manufactured from ultra clear, virgin polypropylene by fully automatic, human touch free machines.
- Manufactured in class 10.000 sterile areas as "DNase, RNase & pyrogen free" product.
- Uniform and thin wall design accelerates the thermal heat transfer and shortens the PCR reaction and cycling times.
- Optimum tube dimensions guarantee compatibility with most leading thermal cyclers.
- Cap inner design ensures hermetical and leak-proof closure
- Once cap is closed the tubes guarantee perfect sealing during thermal cycling preventing evaporation.
- Cap can be opened and closed with one hand without the risk of sample contamination.
- Group packed with lot number, production date and expiry date printed on the package.

catalogue number	pack quantity	box quantity
123.01.002	500 pieces	6 packs/3000 pieces



PCR TUBES - "8 strip"

- 8 strip PCR tubes for thermal transfer and PCR applications are manufactured from ultra clear, high grade polypropylene by fully automatic, human touch free machines.
- They perfectly fit to all PCR plates and provide fast filling option by 8 channel pipettors.
- Manufactured in class 10.000 sterile areas as "DNase, RNase & pyrogen free" product.
- Uniform and thin wall design accelerates the thermal heat transfer and shortens the PCR reaction and cycling times.
- Unique design offers compatibility with most leading PCR thermal cyclers.
- Once caps are closed the tubes guarantee perfect sealing during thermal cycling preventing evaporation. Caps can be opened and closed with one hand without the risk of sample contamination.
- Group packed with lot number, production date and expiry date printed on the package.



catalogue number	volume	product descriptions	pack quantity	box quantity
123.01.028	0,2 ml	clear PCR strips with attached flat caps	12 pieces	10 packs / 120 pieces
123.03.028	0,2 ml	clear PCR strips with separate flat caps	12 pieces	10 packs / 120 pieces

qPCR TUBES - "8 strip" - "with flat cap"

- 8 strip 0,1 ml qPCR tubes for thermal transfer and qPCR applications are manufactured from ultra clear, high grade polypropylene by fully automatic, human touch free machines. Manufactured in class 10.000 sterile areas as "DNase, RNase & pyrogen free" product.
- Uniform and thin wall design accelerates the thermal heat transfer and shortens the PCR reaction and cycling times. Low profile tube design offers compatibility with most leading qPCR machines.
- Once caps are closed the tubes guarantee perfect sealing during thermal cycling preventing evaporation. Caps can be opened and closed with one hand .



- Group packed with lot number, production date and expiry date printed on the package.

catalogue number	volume	product descriptions	pack quantity	box quantity
123.02.028	0,1 ml	clear qPCR strips with seperated flat caps	12 pieces	10 packs / 120 pieces
123.02.018	0,2 ml	clear qPCR strips with seperated flat caps	12 pieces	10 packs / 120 pieces

PCR PLATES

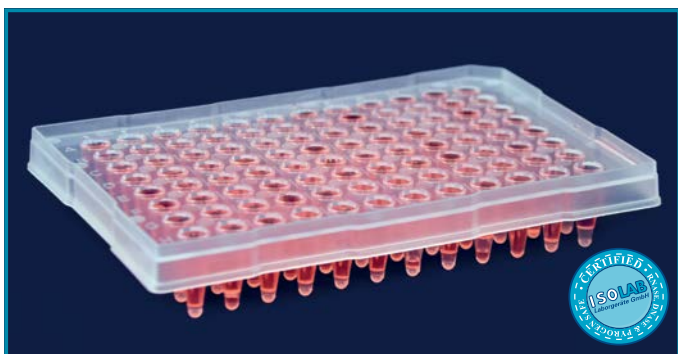
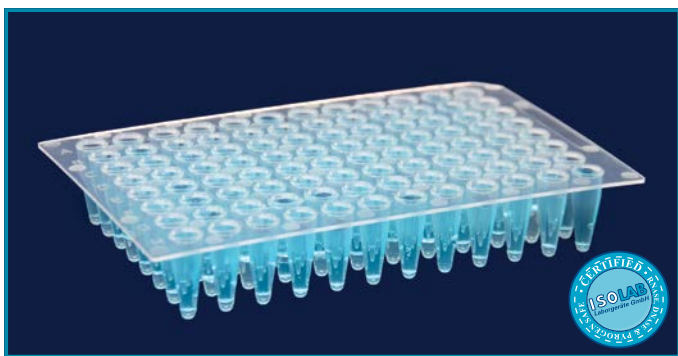

- 96 well PCR plates with 0,2 ml wells for thermal transfer and PCR applications are manufactured from ultra clear, virgin polypropylene by fully automatic, human touch free machines.
- Manufactured in class 10.000 sterile areas as “DNase, RNase & pyrogen free” product.
- Uniform and thin wall design accelerates the thermal heat transfer and shortens the reaction and cycling times.
- Unique design offers compatibility with most leading PCR machines
- Alphanumerical index on tube rows enables easy identification of tube positions.
- Single packed with lot number, production date and expiry date printed on the package.

catalogue number	product descriptions	pack quantity	box quantity
123.01.096	Non- skirted	10 pieces	5 packs / 50 pieces
123.02.096	Semi skirted	10 pieces	5 packs / 50 pieces

SEALING FILMS - “for PCR and qPCR plates”

- Manufactured from polyester based film with acrylic adhesive back. “DNase, RNase & pyrogen free” product.
- Guarantees excellent chemical and temperature resistance between -40°C to +120°C.
- Can be used with all kinds of microplates including raised rim and skirted ones. Transparency allows optical analysis possibility of PCR and qPCR applications.
- Allows easier and more accurate positioning and more secure sealing around each well.
- Prevents cross contamination between samples and wells.
- Also does not interfere with cycle reactions and does not cause spills on PCR samples.



catalogue number	product descriptions	pack quantity	box quantity
124.01.001	Membranes for PCR plates	10 pieces	100 pieces

PCR RACK & WORK STATION

- Manufactured from polypropylene for “before” and “after” use at PCR sampling and applications.
- Rack can carry 3 different size PCR tubes & PCR strips.
 - 96 x 0,2 ml PCR tubes (8x12 array)
 - 12 x strip of 8 PCR tubes (8x12 array)
 - 8 x strip of 12 PCR tubes (8x12 array)
- Alphanumerical index on tube rows enables easy identification of tube positions.

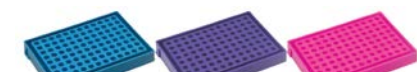

blue rack	purple rack	ruby rack	rack (mm) dimensions	pack quantity
089.03.012B	089.03.012P	089.03.012R	125x88x31	1 piece

- Rack can carry 3 different size tubes
 - 32 x 0,2 ml PCR tubes (4x8 array)
 - 16 x 0,5 ml PCR tubes (2x8 array)
 - 24 x 1,5 ml micro tubes (4x6 array)

catalogue number	rack dimensions	pack quantity
089.03.013	210 x 115 x 50 mm	1 piece

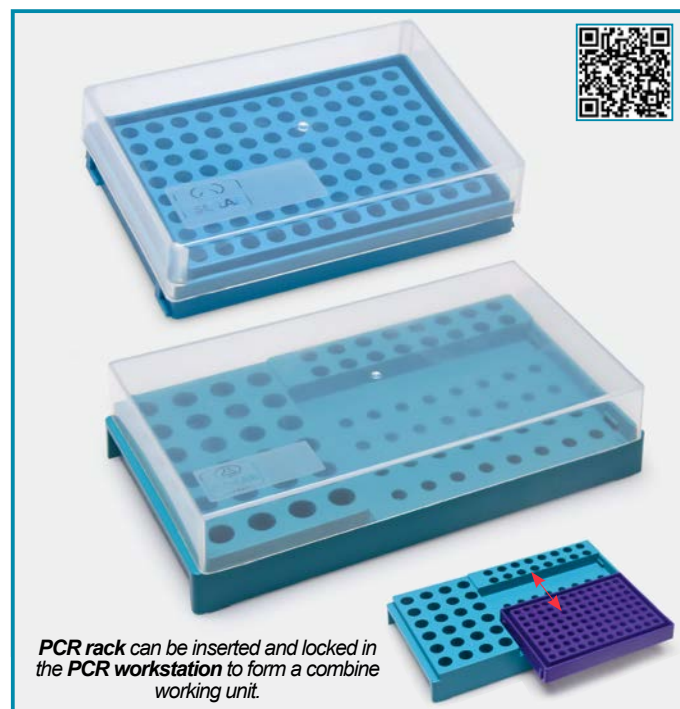



FLASKS - "for cell culture"

- Manufactured from optically clear polystyrene in germ-free, class 10.000 sterile production areas and then resterilised by gamma irradiation. Supplied with a certificate as a guarantee of "DNase, RNase & pyrogen free" product.
- Offers absolutely flat growth surface with surface activated growth area for fast and efficient growth.
- Special design offers minimized contamination risk. Angled design of the flask neck allows easy access to each corner with 100 % cell retrieval without leaving any dead corners.
- Caps are made from polypropylene with large ridges with increased grip. Cap inner design ensures hermetical and leak-proof closure.
- Caps can be opened and closed with single hand. A 2/3 turn of the cap will be sufficient for hermetic and leak-proof closure.
- Graduations on the side wall offer visual control of the filled volume. Marking area on side wall enables easy marking and labelling.
- Individually single packed with lot number, production date and expiry date printed on the package.

catalogue number	growth area	working volume	cap type	surface treatment	pack quantity	box quantity
120.11.025	25 cm ²	7 ml	vent cap with filter	yes	5 pieces	200 pieces
120.11.075	75 cm ²	25 ml	vent cap with filter	yes	5 pieces	100 pieces
120.11.175	182 cm ²	50 ml	vent cap with filter	yes	5 pieces	40 pieces
120.12.025	25 cm ²	7 ml	plug seal cap	yes	5 pieces	200 pieces
120.12.075	75 cm ²	25 ml	plug seal cap	yes	5 pieces	100 pieces
120.12.175	182 cm ²	50 ml	plug seal cap	yes	5 pieces	40 pieces

"plug cap for airtight culture"



Plug seal cap usually used for airtight culture applications. Can be used also for open culture when the cap is unscrewed.

"plug cap for airtight culture"



Vent cap is designed for open culture applications. Includes a contamination preventing hydrophobic membrane 0,2 µm.



Angled design of the flask neck allows easy access to each corner with 100 % cell retrieval without leaving any dead corners.



Ergonomic design minimizes contamination and raised corners at the body enables easy and slip-free stacking possibility.

CENTRIFUGE TUBES - "for cell culture"

- Manufactured from **FDA approved** ultra clear, high grade polypropylene. Can resist centrifugation up to 6.000 RCF.
- Sterilized with gamma irradiation, **free of RNase, DNase, and pyrogene**.
- Individual packing eliminates the possible risks of contaminations.
- Their conical bottoms make them suitable for centrifugation tests in immunology, microbiology etc.

Other technical specifications can be seen at catalogue page no 180 - 181.





MULTIWELL PLATES - "for cell culture"

- Widely used plates for handling multiple samples in a single experiment during culture. Manufactured from optically clear polystyrene in germ-free, class 10.000 sterile production areas and then resterilized by gamma irradiation. Supplied with a certificate as a guarantee of "DNase, RNase & pyrogen free" product.
- Offers absolutely flat growth surface with surface activated growth area for fast and efficient growth. Unique design guarantees minimized cross contamination risk. They offer also easy handling with slip-free stacking possibility. Lid with air-venting system for controlled gas exchange with low evaporation.
- Vented base guarantees excellent air flow between stacked dishes to prevent condensation. Sloped edge allows placement of the lid in one single position. Uniform well volumes always ensures equal growth surface area.
- Individually single packed with lot number, production date and expiry date printed on the package.



Ergonomic design offers minimized contamination risk and easy handling with slip-free stacking possibility.

catalogue number	well quantity	well type	external dimensions (mm)	well dimension	growth area	working volume	surface treatment	pack quantity	box quantity
122.11.006	6	flat	85.4 x 127.6 x 22.5	35.0 x 17.5 mm	9.60 cm ²	3 ml	yes	1 piece	100 pieces
122.11.012	12	flat	85.4 x 127.6 x 22.5	22.1 x 17.5 mm	3.85 cm ²	2 ml	yes	1 piece	100 pieces
122.11.024	24	flat	85.4 x 127.6 x 22.5	15.5 x 17.5 mm	1.93 cm ²	1 ml	yes	1 piece	100 pieces
122.11.048	48	flat	85.4 x 127.6 x 22.5	9.75 x 17.5 mm	0.84 cm ²	0,5 ml	yes	1 piece	100 pieces
122.11.096	96	flat	85.4 x 127.6 x 16.0	6.50 x 10.8 mm	0.33 cm ²	0.2 ml	yes	1 piece	100 pieces
122.11.196	96	round	85.4 x 127.6 x 16.0	6.92 x 12.0 mm	0.58 cm ²	0,2 ml	yes	1 piece	100 pieces

PETRI DISHES - "for cell culture" - "sterile"

- Manufactured from optically clear, transparent polystyrene specially for cell culture practices.
- Manufactured in germ-free, class 10.000 sterile production areas and then resterilized by gamma irradiation.
- Supplied with a certificate as a guarantee of "DNase, RNase & pyrogen free" product.
- Stacking ring on the lid and the corresponding base part guarantees secure stacking option.
- Surface treated uniform flat growth surface guarantees excellent suspension for cultures.

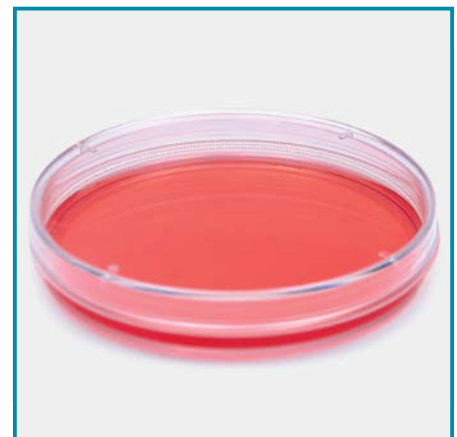

catalogue number	diameter	height	growth area	working volume	surface treatment	external grip	pack quantity	box quantity
120.13.035	32.8 mm	13 mm	8.5 cm ²	3 ml	yes	yes	10 pieces	960 pieces
120.13.060	52 mm	17 mm	21.2 cm ²	5 ml	yes	yes	10 pieces	600 pieces
120.13.090	84.6 mm	17 mm	55.0 cm ²	12.5 ml	yes	yes	10 pieces	500 pieces

MAGNIFIER - "table top"

- Multifunctional table-top magnifier offers magnification power of 3X and 5X depending on view direction.
- Can be operated by one hand. Offers smooth and easy use with distant and near vision lenses.
- 4 LED bulbs with on/off control provide super bright powerful illumination.
- Two separate flexible gooseneck holders enable magnifying lens and illumination angle adjustable in multiangular axes.
- Shadow and flicker free illumination without heat development provides optimal concentration of light.
- Aspherical lens provides spherical aberration and distortion free images with edge-to-edge sharpness.
- Removable main body can be fixed at table corner with a clamp.
- Sturdy base plate increases the standing efficiency.
- The clamp mechanism at the base enables fixation of objects firmly in place.

catalogue number	pack quantity
065.10.001	1 piece

MAGNIFIER - "handy type"

- Hand magnifier offers magnification power of 3X and 5X depending on view direction.
- Handle perfectly fits to hand with a comfortable grip.
- Aspherical lens provides spherical aberration and distortion free images with edge-to-edge sharpness.
- LED bulb with on/off control provides super bright powerful illumination.
- A rotatable joystick switch enables adjustment of illumination angle in all angles.

catalogue number	external dimensions	lens dimensions	pack quantity
065.10.006	230 x 100 mm	100 mm	1 piece

MAGNIFIER - "pocket type"

- Perfect magnifier for reading small prints with magnification power of 2X.
- 3 LED bulbs with on/off control provides super bright powerful illumination.
- Ergonomic design enables intuitive movement on the reading material. Delivered in a soft protective bag

catalogue number	external dimensions	lens dimensions	pack quantity
065.10.004	60 x 145 mm	60 x 100 mm	1 piece



REFRACTOMETER - "digital"

- With a wide measuring range offers a precise measurement and determination of refractive index and Brix values of liquid samples.
- Portable, light weight, compact design guarantees fast and easy measurements also eliminates the reading errors.
- Operation is extremely simple: only with a few drops of sample guarantees fast and reliable measurements.
- Zero point check and calibration can be done with water.
- LED light source around the prism warns the user during the calibration or measurement process.
- Simple and easy to change measuring from % Brix to refractive index. Features with automatic temperature compensation (ATC).

catalogue number	measuring range % Brix	measuring range refractive index	division Brix / RI	ATC
618.32.001	0 - 95	1,3330 - 1,5400	0,1/0,0001	yes



- Ideal for precise measurement and determination of refractive index and % Brix values of liquid, solid, semi-solid and powder samples. Simple handling and easy to use. Calibration can be done easily with supplied calibration prism.



REFRACTOMETER - "hand type"

- A practical alternative for practical yet quick measurement of concentrations of liquids.
- Portable and hand-held design enables both laboratory and field applications.
- Models with automatic temperature compensation are specially suitable for field use.
- With focusing eyepiece with soft rubber eyecups for reducing straylight ingress and also avoiding scratches at spectacle lenses.
- Calibration is easily done by turning the adjustment screw.

catalogue number	measuring range % Brix	division %	ATC
618.21.001	0 - 10	0,1	yes
618.22.001	0 - 18	0,1	yes
618.23.001	0 - 32	0,2	yes
618.24.001	0 - 80	0,5	no
618.25.001	0 - 90	0,5	no

REFRACTOMETER - "ABBE"

- Large optical prism enables excellent boundary line brightness and contrast during measurements.
- Adjustable wide field eyepiece with 10X magnification, enables bright and clear images. Super contrast, optical system with 30X magnification guarantees sharp images.
- Equipped with movable, hinged covers to keep light out. Offers connection possibility to a thermostatic circulator.
- Featured with a digital thermometer with a large LCD display. Temperature reading is selectable as °C or °F with a precision of 0,1°C or 0,1°F.

catalogue number	618.41.001
external dimensions (mm)	270 x 180 x 370
refractive index (nD)	1,3000 - 1,7000
dissolved solid Brix (%)	0 - 95
accuracy	± 0,0002
water inlet / outlet Ø (mm)	10
digital thermometer	LCD display - 34 x 14 mm
temperature range (°C)	0 - 70
temperature uniformity (°C)	± 0,1

MICROSCOPE - "biological"



- Ideal for academic and clinical research with excellent optical system, outstanding resolution and definition.
- Unique design with backward nosepiece offers larger working space and enables convenient handling.
- Featured with a 360° rotatable binocular head inclined at 30 with interpupillary distance adjustable 50 mm - 75 mm.
- Wide field eyepiece with 10X magnification power, 20mm lens diameter enables bright and clear images
- 4X, 10X, 40X and 100X plan achromatic objectives guarantee net and sharp images. NA 1,25 abbe condenser with iris diaphragm and filter holder guarantees ideal contrast.
- 142x138 mm square mechanical stage with 76 mm left-right and 55 mm back-forward movement offers easy use.
- Coarse and fine adjustment is enabled with upper limit safety with 0,002 mm fine division and 20 mm maximum moving limit. Each rotation of control knob enables 37,7 mm coarse stroke and 0,2 mm fine stroke.
- Featured with a power supply 100 Volt - 220 Volt multi input rating and easily replaceable, super bright and powerful LED illumination with adjustable light power.
- Supplied with dust cover and immersion oil.

catalogue number	pack quantity
613.21.001	1 piece



Featured with a 360° rotatable binocular head inclined at 30 with interpupillary distance adjustable 50 mm - 75 mm.



Featured with a power supply 100 Volt - 220 Volt multi input rating and super bright. LED illumination with adjustable light power.



142x138 mm square mechanical stage with 76 mm left-right and 55 mm back-forward movement offers easy use.



Coarse and fine adjustment is enabled with upper limit safety with 0,002 mm fine division and 20 mm maximum moving limit.



IMAGE PROJECTOR

- Consists of a scientific research camera with Aptina CMOS sensor for advanced video and image processing.
- Offers excellently clear projection of the images from microscopes to screens and practical photo and video shootings.
- Featured with hardware resolution among 0,35M to 14M and USB 2.0 interface for high speed data transmission. Ultra-fine color engine guarantees perfect color reproducibility.
- Other pcs are; Maximum resolution: 8.000.000 Pixels / Pixel size: 1,67 μm x 1,67 μm / Dynamic range: 65,2 dB. / SN ratio: 34 dB / Spectral range: 380 – 650 nm / Exposure: 0,38 ms – 2000 ms, ROI Auto & Manual.
- Sturdy zinc aluminium housing for a very long life cycle.

catalogue number	pack quantity
613.31.001	1 piece

MICROSCOPE - "stereo"



- Offers ergonomic design, sharp image quality, high resolution and wide field of viewing for academic, industrial and clinical applications.
- Featured with a 360° rotating binocular head inclined at 45 with interpupillary distance adjustable 52 mm - 75 mm.
- Wide field eyepiece with 10X magnification power with 20mm view field enables bright and clear images.
- Adjustable objective with 0,7 X to 4,5X magnification power provides a wide and clear viewing field of 20 mm diameter with zoom ratio of 1:6,4
- Featured with a power supply 100 Volt - 220 Volt multi input rating and easily replaceable, super bright and powerful LED illumination from bottom and overhead.
- Supplied with dust cover, and circular examination glass plate and an additional examination plate with one side black and other side white.

catalogue number	pack quantity
613.22.001	1 piece



Supplied with an additional examination plate with one side black and other side white.



Featured with a 360° rotating binocular head inclined at 45 with interpupillary distance adjustable 52 mm - 75 mm.



Objective with 0,7 X to 4,5X magnification power provides a wide and clear viewing field of 20 mm diameter with zoom ratio of 1:6,4.



Featured with a power supply 100 Volt - 220 Volt multi input rating and super bright and powerful. **LED illumination from bottom.**



Featured with a power supply 100 Volt - 220 Volt multi input rating and super bright and powerful. **LED illumination from overhead.**

MICROSCOPE SMART TABLET



- Offers a built-in image capture and video record 9.7 inch touch screen tablet, with a resolution of 2048(H) x 1536(V).
- Consists of a 5.000.000 pixels camera system and 1080p video support.
- Futures for measuring line length, curve length, parallel line distance and point line distance. Also geometric measurements are available such as Radius of the circle line, three point circle and concentric circle.
- Supplied with adapting lens to convert from C-mount to 23.2 mm eyepiece tube, with 30.0 mm adaptor rings and 30.5 mm adaptor rings to fit most of the microscopes.

catalogue number	pack quantity
613.41.001	1 piece



COVER GLASSES - "for counting chambers"



➤ Manufactured from special optical glass with ground and polished edges.

➤ These cover glasses are used to cover specimens in counting chambers.

➤ With their excellent flat surfaces they adhere perfectly on the chambers and define the volume of the cell suspension over the counting grid.

➤ Their substantial thickness of 0,4 mm offers perfect results without bending under capillary forces.

➤ Their practical dimensions of 20 x 26 mm enables use with almost chamber types.

catalogue number	pack quantity
075.04.001	10 pieces

BLOOD COUNTING CHAMBERS

➤ Manufactured from special optical glass according to DIN 12847 standard.

➤ It is possible to count different types of cells such as leukocyte, erythrocytes with simple methods under a microscope.

➤ Tolerance of the depth of the chamber does not exceeds 2 %.

➤ Counting grids are engraved into two polished surfaces at the central station.

➤ **"Neubauer - improved" chamber** with grid consists of 3 x3 large squares with areas of 1 mm² each.

➤ **Alternative 2 chambers:**

➤ **"Thoma - new" chamber** with 0,1 mm depth. The grid covers an area of 1,1 x 1,1 mm².

➤ Supplied in a polystyrene box together with two haemocytometer cover glasses.

catalogue number	product descriptions	pack quantity
075.03.001	Neubauer Improved	1 piece
075.03.002	Thoma - New	1 piece

CELL COUNTER - "mechanical"

➤ Multi use mechanical counter with maximum counting capacity up to 9999 for counting blood cells, bacterial colonies, drops of liquids, or any repetitive action.

➤ Featured a quick reset knob, lens window for easy reading, and finger ring for a secure grip.

➤ Sturdy and chrome finished metal housing offers long life cycle.



catalogue number	pack quantity
081.14.002	1 piece



CELL COUNTER - "digital"

➤ Multi-use digital counter with maximum counting capacity up to 9999 for counting blood cells, bacterial colonies, drops of liquids, or any repetitive action.

➤ Featured a quick reset knob, lens window for easy reading, and finger ring for a secure grip.

➤ Sturdy and chrome finished metal housing offers long life cycle.

catalogue number	pack quantity
081.14.001	1 piece

COVER GLASSES

- Manufactured from optical grade, hydrolic 1 class borosilicate glass according to DIN ISO 8255 standard.
- Fully automatic production cycles ensure dust-free, absolutely clean cover glasses with excellent flatness and smooth surfaces.
- With their thickness varying 0,13 mm - 0,17 mm they guarantee perfect clearness.
- Their edges are cut with highest precision assuring flawless results.
- **Alternative 2 glasses:** ➤ **economical quality cover glasses**
➤ **superior quality cover glasses**

dimensions	economic quality	box quantity	superior quality	box quantity	pack quantity
18 x 18 mm	075.00.001	10 packs	075.01.001	10 packs	100 pcs
20 x 20 mm	075.00.002	10 packs	075.01.002	10 packs	100 pcs
22 x 22 mm	075.00.003	10 packs	075.01.003	10 packs	100 pcs
24 x 24 mm	075.00.004	10 packs	075.01.004	10 packs	100 pcs
24 x 32 mm	075.00.005	10 packs	075.01.005	10 packs	100 pcs
24 x 50 mm	075.00.006	5 packs	075.01.006	10 packs	100 pcs
24 x 60 mm	075.00.007	5 packs	075.01.007	10 packs	100 pcs



SLIDES

- Manufactured from optical grade, hydrolic 3 class soda lime glass according to DIN ISO 8037-1 standard.
- Fully automatic production cycles ensure dust-free, absolutely clean cover glasses with excellent flatness and smooth surfaces.
- With their extremely flat pre-cleaned surfaces free of dust and oil and their 1 mm thickness they assure flawless results.
- **Alternative 2 slides:** ➤ **economical quality cover glasses**
➤ **superior quality cover glasses**
- Superior quality color coded slides has ground edges with 45° edge angle.
- Color coded with 5 different colors enables fast, easy identification.



Superior quality color coded slides with 5 different colors provide easy identification of samples.



Superior quality slides have ground edges with 45° edge angle.



economic quality	superior quality	product descriptions	edge angle	color code	pack quantity	box quantity
075.05.001		Cut edges, Plain	90° Degree	---	50 pieces	50 packs
075.05.002		Cut edges, Frosted one end one side	90° Degree	---	50 pieces	50 packs
075.05.003		Ground edges, Plain	90° Degree	---	50 pieces	50 packs
075.05.004		Ground edges, Frosted one end two side	90° Degree	---	50 pieces	50 packs
	075.02.005	Ground edges, Color Frosted	45° Degree	white	50 pieces	50 packs
	075.02.006	Ground edges, Color Frosted	45° Degree	yellow	50 pieces	50 packs
	075.02.007	Ground edges, Color Frosted	45° Degree	green	50 pieces	50 packs
	075.02.008	Ground edges, Color Frosted	45° Degree	pink	50 pieces	50 packs
	075.02.009	Ground edges, Color Frosted	45° Degree	blue	50 pieces	50 packs



SLIDE BOX - "with hinged lid"

- Manufactured from robust polypropylene providing perfect storage and transportation of slides.
- Moulded grooved slide slots with numerical index hold the microscope slides at the position.
- Hinged lid offers safe closing and easy opening. Once the lid is closed the box interior is protected from environmental effects.



Different color options offers easy slide classification and minimize the possibility of sample mix-up.

slide box for 25 slides	slide box for 50 slides	slide box for 100 slides	box color	pack quantity
076.02.000W	076.02.001W	076.02.002W	white	1 piece
076.02.000B	076.02.001B	076.02.002B	blue	1 piece
076.02.000P	076.02.001P	076.02.002P	purple	1 piece
076.02.000R	076.02.001R	076.02.002R	ruby	1 piece
076.02.000O	076.02.001O	076.02.002O	orange	1 piece



SLIDE BOX - "with steel latch"

- Manufactured from robust ABS providing perfect storage and transportation option of slides.
- Moulded grooved slide slots with numerical index hold the microscope slides at the position.
- Hinged lid with steel latch offers safe closing and easy opening. Once the lid is closed the box interior is protected from environmental effects.



catalogue number	slide capacity	box color	pack quantity
076.02.012W	100 slides	white	1 piece
076.02.012B	100 slides	blue	1 piece
076.02.012R	100 slides	ruby	1 piece
076.02.012P	100 slides	purple	1 piece
076.02.012O	100 slides	orange	1 piece



SLIDE BOX CABINET

- Manufactured from acrylate with 5 slide box compartment.
- They offer practical solutions for storing the slide boxes on top of each other. Can be linked to each other by magnetic fixators to form longer working station.

catalogue number	pack quantity
076.02.101	1 piece



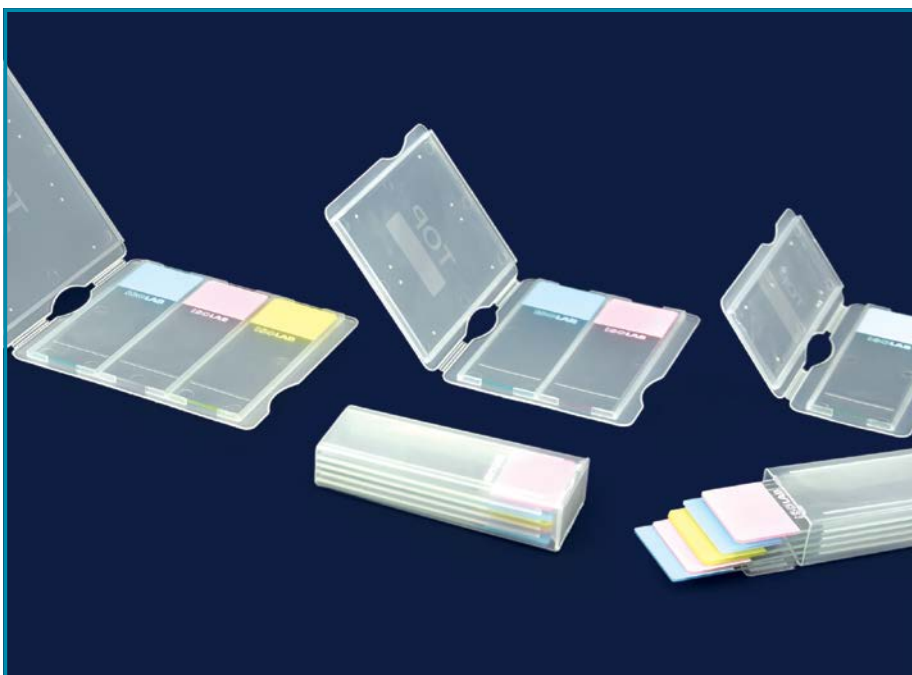

SLIDE MAILERS

- Manufactured polypropylene for storing and shipping of slides.
- Flat mailers can carry 1 or 2 or 3 slides depending on the type.
- Easy-to-close snaps hold the mailers always securely closed while keeping the interior away from dust, moisture and other environmental effects.
- Box mailer with slotted channels can hold 5 slides separated from each other.
- The hinged lid protects the mailer interior from dust and other environmental effects.

catalogue number	slide capacity	pack quantity	box quantity
076.05.001	1 slide	1 piece	100 pieces
076.05.002	2 slides	1 piece	100 pieces
076.05.003	3 slides	1 piece	100 pieces
076.05.004	5 slides	1 piece	100 pieces

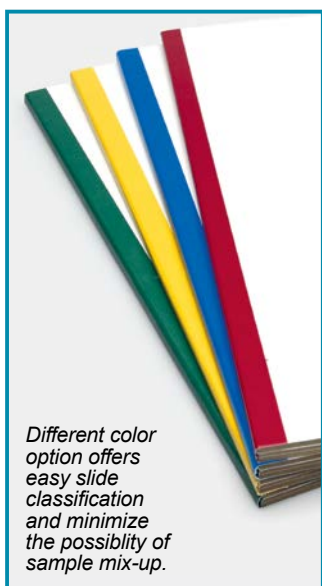

Different color option offers easy slide classification and minimize the possibility of sample mix-up.

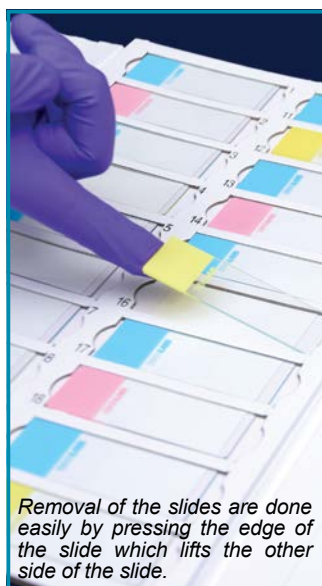

Removal of the slides are done easily by pressing the edge of the slide which lifts the other side of the slide.



SLIDE WALLETS - "cardboard"

- Manufactured from thick and robust cardboard with 20 pieces slide capacity. Consists of 2 parts: A base for slide compartments and two folding covers.
- Unique recessed design of the slide compartments avoids the risk of covers touching the slides.
- Alphanumerical index on slide rows enables easy identification of slide positions.
- Printed marking area on side walls of the covers enables easy marking and labelling.
- Slide compartments have finger slots for easy and fast removal of the slides.
- Cardboard hinged covers protect the slides from environmental effects.

SLIDE WALLET RACK

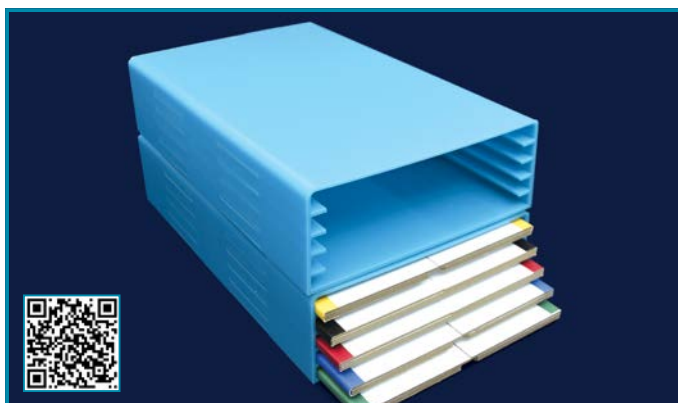

- Manufactured from thick and robust acrylic for easy and safe storage of 5 slide wallets. For easy insertion and removal of the slide wallets also protects the wallet interior.

- Easily stackable due to the body form for reducing storage space.

catalogue number	pack quantity
076.01.003	1 piece

catalogue number	dimension	rack color	pack quantity
076.01.001W	205x340x10 mm	white	1 piece
076.01.001B	205x340x10 mm	blue	1 piece
076.01.001R	205x340x10 mm	red	1 piece
076.01.001Y	205x340x10 mm	yellow	1 piece
076.01.001G	205x340x10 mm	green	1 piece



PETRI DISHES - "glass"

- Manufactured from heat resistant glass with counter sinking process which guarantees bubble-free dishes.
- Lids perfectly fit to the body enabling easy handling.
- Extremely flat bottom base guarantees an even media dispersion and uniform cell growth.
- Fire polished body and lid edges enable safe use by reducing the risk of breakage.



catalogue number	diameter	height	pack quantity
081.01.060	60 mm	15 mm	18 pieces
081.01.080	80 mm	15 mm	18 pieces
081.01.100	100 mm	20 mm	18 pieces
081.01.120	120 mm	20 mm	18 pieces
081.01.150	150 mm	25 mm	18 pieces

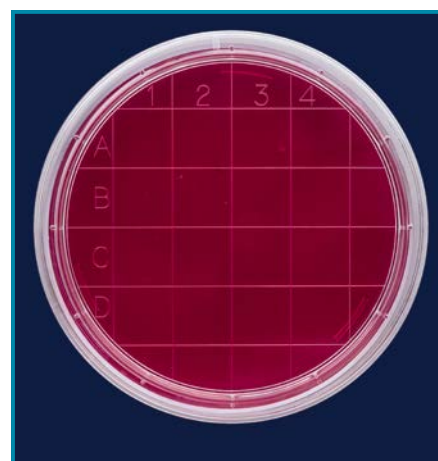

PETRI DISHES "contact" - "rodac"

➤ Manufactured from optically clear, transparent polystyrene for determining bacterial contamination of surfaces such as the skin and all other surfaces. Also facilitates the counting of colonies.

➤ Featured with a moulded grid at the bottom which enables the identification of the detected contamination / cm².

➤ Aseptic petri dishes are manufactured in germ-free, class 10.000 sterile production areas with extreme sterility control.

➤ Sterile petri dishes are manufactured in germ-free, class 10.000 sterile production areas and then resterilized by gamma irradiation.

➤ Sterile petri dishes are supplied with a certificate as a guarantee of "DNase, RNase & pyrogen free" product.

PETRI DISHES - "polystyrene" - "sterile"

➤ Manufactured from optically clear, transparent polystyrene for multiple use in microbiology and bacteriology. Manufactured by fully automatic, human touch free machines.

➤ Ideal body form guarantees excellent use with automatic filling machines. Vented lids enable consistent and effective practice.

➤ **Alternative 2 dishes:** ➤ Aseptic petri dishes
➤ Gamma sterile petri dishes

➤ Aseptic petri dishes are manufactured in germ-free, class 10.000 sterile production areas with extreme sterility control.

➤ Sterile petri dishes are manufactured in germ-free, class 10.000 sterile production areas and then resterilized by gamma irradiation. Sterile petri dishes are supplied with a certificate as a guarantee of "DNase, RNase & pyrogen free" product.

diameter x height	section	clean room produced	box quantity	gamma sterilized	box quantity
60 x 15 mm	1 section	081.02.061	500 pieces	081.02.161	500 pieces
90 x 17 mm	1 section	081.02.091	500 pieces	081.02.191	360 pieces
90 x 17 mm	2 section	081.02.092	500 pieces	081.02.192	360 pieces
90 x 17 mm	3 section	081.02.093	500 pieces	081.02.193	360 pieces
90 x 17 mm	4 section	081.02.094	500 pieces	081.02.194	360 pieces
120 x 17 mm	1 section	081.02.121	500 pieces	081.02.221	400 pieces

petri dishes clean room produced	diameter x height	pack quantity	box quantity
081.04.060	66 x 15 mm	10 pieces	500 pieces

petri dishes gamma sterilized	diameter x height	pack quantity	box quantity
081.04.160	66 x 15 mm	10 pieces	500 pieces

COLONY COUNTER



➤ Ideal for fast and practical manual counting of colonies on any agar in petri dishes. The versatile unique design accepts petri dishes from 40 mm to 100 mm.

➤ Intelligent counter with LED digitron display allows fast and precise count of the colonies between 0 - 999. Numericals on the counter can be adjusted backward and forward manually.

➤ Featured with a 90 mm high quality magnifier with 3x / 9x magnification power magnifier attached to a goose neck, flexible holder.

➤ Flexible holder enables both magnifying lens position and illumination angle adjustable in multiangular axes.

➤ Counting table is featured with a backward LED illumination with variable light control. Circular LED illumination system offers a shadow and flicker free illumination.

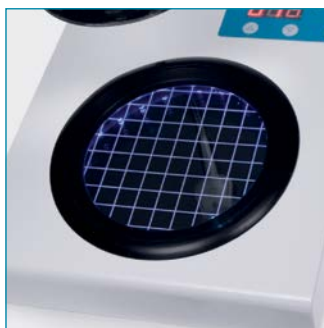

Circular LED illumination system offers a shadow and flicker free illumination without heat development with optimal concentration of light.

1 square centimeter cross sectional template of the counting plate guarantees reliable counting.



Marking is done by a "felt pin pen" which is connected to the system by cable.

Intelligent counter with LED digitron display allows fast and precise count of the colonies between 0 - 999.

catalogue number	for petri dishes	external dimensions	pack quantity
603.11.001	40 - 100 mm dia.	210 x 255 x 160 mm	1 piece

PETRI DISH BASKET - "st. steel"



➤ Manufactured from high quality, chemical and corrosion resistant AISI 304 grade stainless steel.

➤ Ideal tool for transportation and autoclaving of petri dishes with maximum 100 mm diameter.

➤ Petri dish basket can carry maximum 10 petri dish.

catalogue number	pack quantity
081.20.001	1 piece



Sealing tape for petri dishes can be seen on catalogue page no 74.

PETRI DISH STAND



➤ Manufactured from acrylic for safe storing, transportation of petri dishes. Also very useful during inoculation and incubation.

➤ Also provides streamline benchtop sample processing and protects petri dishes from dust, moisture and other environmental effects.

➤ Center divider provides space for labelling and incorporates built in finger grip for easy handling. Can be linked to each other by the magnetic fixators at both sides.

catalogue number	for petri dish Ø	dish capacity	pack quantity
081.13.060	60 mm	30	1 piece
081.13.090	90 mm	60	1 piece

INOCULATION LOOPS - "HIPS" - "sterile"



➤ Aseptic inoculation loops are manufactured from HIPS in germ-free, class 10.000 sterile production areas.

➤ Supplied with a certificate as a guarantee of "DNase, RNase & pyrogen free" product.

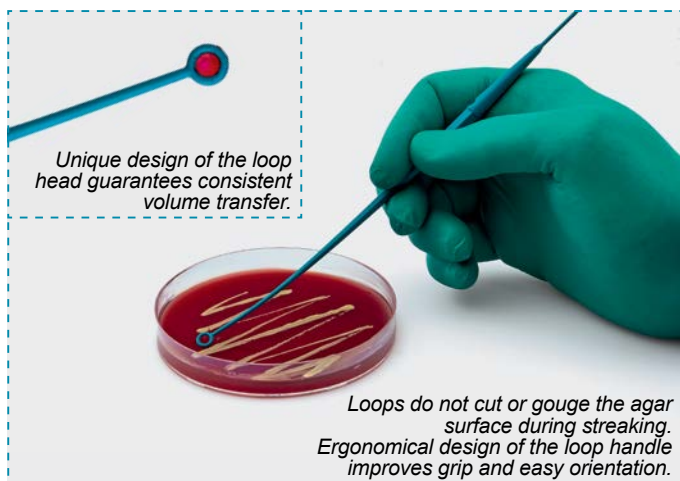

➤ Highly flexible body form enables comfortable and efficient planting and avoids streaking of cultures.

➤ Anti-static property of the raw material eliminates problems caused by electrostatic effects and guarantees consistent complete liquid transfer.

➤ Hexagonal loop shaft improves grip, assists orientation and makes diluting and streaking easy.

➤ Hexagonal loop handle also enables orientation of the loop head with a fixed angle.

➤ Ultra smooth loop surfaces allow easy streaking and offer problem-free planting without the risk of cutting or gauging the agar surface.

➤ Double use loops have one side a fine tip specially designed for holding, transporting and counting colonies. The loop at the other for streaking in petri dishes.

➤ Color coded loops enable fast, easy and practical identification of loop type.

catalogue number	loops specification	loop color	pack quantity	box quantity
082.01.001	one end needle / one end 1 μ l	light blue	10 pieces	1000 pieces
082.01.002	one end needle / one end 10 μ l	blue	10 pieces	1000 pieces
082.01.003	one end 1 μ l / one end 10 μ l	dark blue	10 pieces	1000 pieces

INOCULATING TURNTABLE

➤ Light weight but robust body manufactured from aluminium and featured with non-skid feet.

➤ Manually operated turntable guarantees smooth and easy rotation on both directions. Also enables easy and fast allocation of bacteria across petri dish surface.

➤ Double sided construction accomodates petri dishes from 60 to 150 mm diameter by inverting the turntable.

➤ Ball bearings provide a smooth and effortless spinning ensuring rapid inoculation steps and extended operation life.

➤ The silicone pad holds the petri dishes firmly and keeps the dish allways in center position during inoculation steps.

➤ The non-skid pad can easily be removed for fast and efficient cleaning.

catalogue number	pack quantity
081.10.001	1 piece

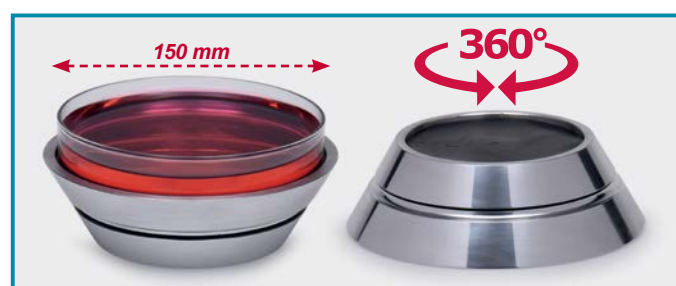
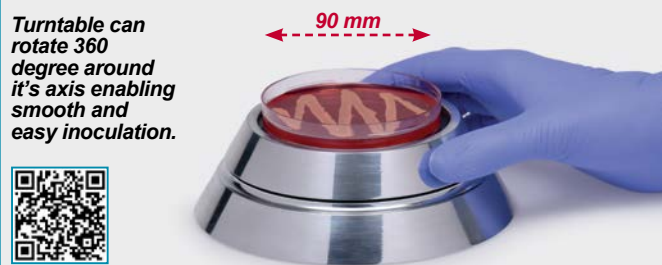



CELL SPREADER - "HIPS" - "sterile"

- Aseptic cell spreader is manufactured from HIPS in germ-free, class 10.000 sterile production areas.
- Supplied with a certificate as a guarantee of "DNase, RNase & pyrogen free" product.
- Ultra smooth, edgeless designed, triangular spreading head allows easy and problem-free spreading without the risk of cutting or gauging the agar surface.
- Highly flexible body form enables comfortable and efficient spreading and avoids streaking of cultures.
- Rippled designed ergonomic handle improves gripping efficiency and assists easy orientation of the spreader head.
- Handle flexes slightly under pressure allowing the triangular head for perfect, evenly distributed and uniform pressure on the agar surface.
- Individually single packed with lot number, production date and expiry date printed on the package.



Handle flexes slightly under pressure allowing the triangular head for perfect, evenly distributed and uniform pressure on the agar surface.

catalogue number	pack quantity	box quantity
082.03.001	1 piece	100 pieces



INOCULATION LOOP HANDLE

- The loop shaft is manufactured from nickel plated brass.
- The shaft of the loop handle is insulated by PVC for further protection of user against heat.
- Featured with a screw fastening end for tight fastening of the loops used.
- Handle guarantees easy holding option and fatigue-free application.

catalogue number	length	pack quantity
082.02.003	200 mm	1 piece



INOCULATION LOOP - "stainless steel"

- These durable loops are manufactured from nickel-chrome metal wire with twisted wire strands.
- Highly flexible body form enables comfortable and efficient planting and avoids streaking of cultures.
- Ultra smooth loop surfaces allow easy streaking and offer problem-free planting without the risk of cutting or gauging the agar surface.
- Can be heated up to 1200°C and can be cooled rapidly after heat sterilisation.

catalogue number	length	pack quantity
082.02.001	50 mm	10 pieces

CELL SPREADER - "stainless steel"

- Manufactured AISI 304 grade stainless steel. Suitable for sterilization by autoclaving or by direct flame.
- Smooth, rounded surfaces prevents any cutting or gouging of agar surface during application.
- Triangular formed spreader head enables even spreading of liquid samples all over the surface.

catalogue number	triangular bar width	handle length	pack quantity
082.03.003	32 mm	190 mm	1 piece





CELL LIFTER - "for cell culture" - "sterile"

- Manufactured from polypropylene and specially designed for scraping of attached cells on culture dishes or plate surfaces. Ideal for manual harvesting of cells.
- Manufactured in germ-free, class 10.000 sterile production areas and then resterilised by gamma irradiation.
- Supplied with a certificate of "DNase, RNase & pyrogen free" product.
- Featured with two flat ends with different widths on a single handle.
- Two blades with different widths offer practical and easy solutions during sample scraping and collection.
- Specially the wide blade end offers ideal solutions for dish and 6 well plates.
- Flat ends have 35 degree sharp edges for easy removal of the residues on flat surfaces.
- Individually single packed with lot number, production date and expiry date printed on the package.

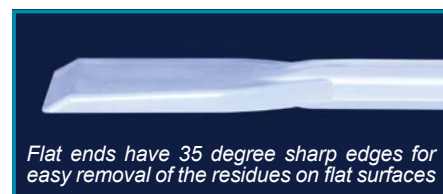
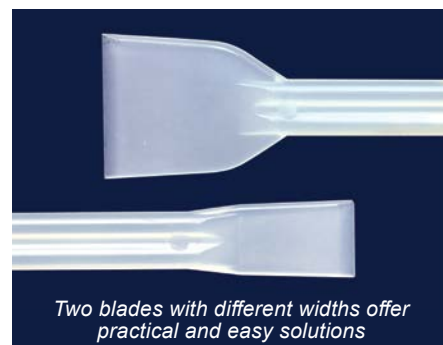

catalogue number	total length	narrow end width	large end width	packing specification	pack quantity
121.01.001	245 mm	12 mm	23 mm	single pack	100 pieces



CELL SCRAPERS - "for cell culture" - "sterile"

- Specially designed to facilitate collection of attached cells on culture dishes.
- Manufactured in germ-free, class 10.000 sterile production areas and then resterilised by gamma irradiation.
- Supplied with a certificate as a guarantee of "DNase, RNase & pyrogen free" product.
- Handle is manufactured from ABS. Scraper head is manufactured from flexible polyethylene.
- Scraper blade rotates around the it's axis enabling easy and flexible applications.
- The rotating blade also guarantees the efficient collection of cells from any angle.
- Ultra smooth blade surfaces offer problem-free collection without the risk of cutting or gauging the agar surface.
- Hexagonal shaft improves grip, assists orientation and makes diluting and streaking easy.
- Hexagonal handle also enables orientation of the loop head with a fixed angle.
- Individually single packed with lot number, production date and expiry date printed on the package.



catalogue number	total length	box quantity
121.11.023	230 mm	150 pieces
121.12.030	300 mm	150 pieces

PIPETTES - "serological" - "polystyrene"

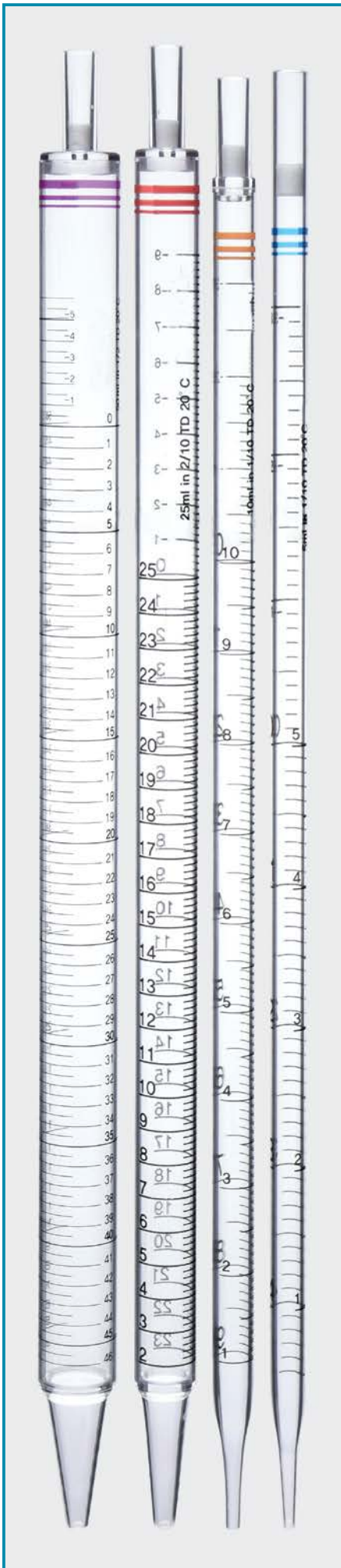

- Manufactured from virgin polystyrene with excellent optical transparency.
- Sterilized with gamma irradiation. Free of RNase, DNase, DNA and pyrogene.
- Unique design offers a smooth interior which prevents cell-hanging and clumping inside the pipette wall.
- Stable and break-resistant pipette tip offers constant the reproducible flow in each time.
- Optimised mouthpiece perfectly fits to all types of pipette pumps and balls.
- Filter plug at the mouthpiece prevents overflow of liquid and also eliminates contamination.
- Color coded ring mark at suction stem allows fast identification and sourcing.
- The sharp, black, highly visible permanent graduations prevent ambiguity and guarantee precise reading and accurate dispensing.
- Reverse graduations show actual removed or remaining volumes on all pipettes larger than 1 ml volume.
- Pipettes are supplied individually wrapped in fiber-free color coded paper as easy-to-open packing.



Volume identification by color coding on pipette enables easy volume identification during working.



Filter plug at the mouthpiece of the pipette prevents exterior effects and minimize contamination.



Accurate volume identification by highly visible bidirectional graduation printed on pipette side body.

Ascending and descending scales facilitate reading both dispensing and remaining volume.

catalogue number	pipette volume	color code	box quantity
083.13.001	1 ml	yellow	500 pieces
083.13.002	2 ml	green	500 pieces
083.13.005	5 ml	blue	200 pieces
083.13.010	10 ml	orange	200 pieces
083.13.025	25 ml	red	150 pieces
083.13.050	50 ml	purple	100 pieces
083.13.100	100 ml	pink	50 pieces

RACK - "for pipettes"

- Manufactured from acrylic for easy organisation of all kind of pipettes.
- 4 shelves guarantee easy and fast reach of all pipettes between 1 ml to 50 ml size within arm's reach.
- Angled design of the pipette shelves prevents the risk of pipettes falling out even the shelf is fully filled.

Other technical specifications can be seen at catalogue page no 15.





STAINING JARS "Schifferdecker"

- Manufactured from heavy walled soda glass for holding microscope slides horizontally.
- Supplied together with a glass lid.
- Offers space for 10 individual microscope slides or 10 pairs of slides adjacently back-to-back.

catalogue number	dimensions	pack quantity
073.03.001	87x74x40 mm	1 piece



STAINING JARS "Hellendahl"

- Manufactured from heavy walled soda glass for holding microscope slides vertically.
- Supplied together with a glass lid.
- Offers space for 8 individual microscope slides or 8 pairs of slides adjacently back-to-back.

catalogue number	dimensions	pack quantity
073.01.001	60x60x105 mm	1 piece



STAINING JAR "Macro"

- Manufactured from heavy walled soda glass for using with a stainless steel slide holding rack.
- Supplied with a lid that provides safe closure of the jar content during non-use.
- Stainless steel staining rack is not supplied together with the jar.

catalogue number	dimensions	pack quantity
073.05.001	105x90x75 mm	1 piece



TISSUE BASE MOULDS

- Manufactured from stainless steel for easy removal of paraffin inclusions.
- They enable easy and precise positioning of the specimens during application.

tissue base mold	external dimensions	internal dimensions	specifications	pack quantity
074.07.001	55 x 38 x 10 mm	7 x 7 x 6 mm	biopsy & hystology	5 pieces
074.07.002	55 x 38 x 10 mm	15 x 15 x 6 mm	biopsy & hystology	5 pieces
074.07.003	55 x 38 x 10 mm	37 x 24 x 6 mm	standard	5 pieces



STAINING JAR RACK

- Manufactured from stainless steel to hold and carry microscope slides.
- Featured with inserts that can hold 20 single slides in horizontal position.
- Long handle offers easy and safe hold.

catalogue number	dimensions	pack quantity
073.06.001	85x70x20 mm	1 piece

EMBEDDING CASSETTES - "without lid"

- Manufactured from POM which is fully resistant to histological solvents.
- The unique design allows perfect fit to all microtome chuck adapters.
- Slanted marking area on front side enables easy marking and labelling.

cassette without lid	color	pack quantity	box quantity
074.01.001	white	500 pieces	5000 pieces
074.01.002	yellow	500 pieces	5000 pieces
074.01.003	green	500 pieces	5000 pieces
074.01.004	pink	500 pieces	5000 pieces
074.01.005	blue	500 pieces	5000 pieces

CASSETTE LID

- Manufactured from high quality, chemical and corrosion resistant AISI 304 grade stainless steel.
- Perforated surface offers the optimal liquid diffusion.
- The body form fits perfectly to the cassettes and guarantees tight closure.

catalogue number	pack quantity
074.02.001	5 pieces



EMBEDDING CASSETTES - "with lid"

- Manufactured from POM which is fully resistant to histological solvents.
- **Histology cassettes with rectangular openings**
- **Alternative 2 cassettes:**
 - **Biopsy cassettes with square openings**
- The unique design allows perfect fit to all microtome chuck adapters.
- The efficient flow-through slots maximize the liquid exchange and also ensure proper drainage.
- The unique design of the lids can be opened and closed as often as necessary without getting loose.
- Lids always relock securely without any risk of specimen loss.
- Slanted marking area with 45° angled on front side enables easy marking and labelling.
- Histology cassettes with rectangular openings provide maximum liquid exchange and does not require use of a pad.
- Biopsy cassettes with square openings provide maximum liquid exchange and does not require use of a pad.

cassette histology	cassette biopsy	color	pack quantity	box quantity
074.03.001	074.04.001	white	500 pieces	5000 pieces
074.03.002	074.04.002	yellow	500 pieces	5000 pieces
074.03.003	074.04.003	green	500 pieces	5000 pieces
074.03.004	074.04.004	pink	500 pieces	5000 pieces
074.03.005	074.04.005	blue	500 pieces	5000 pieces

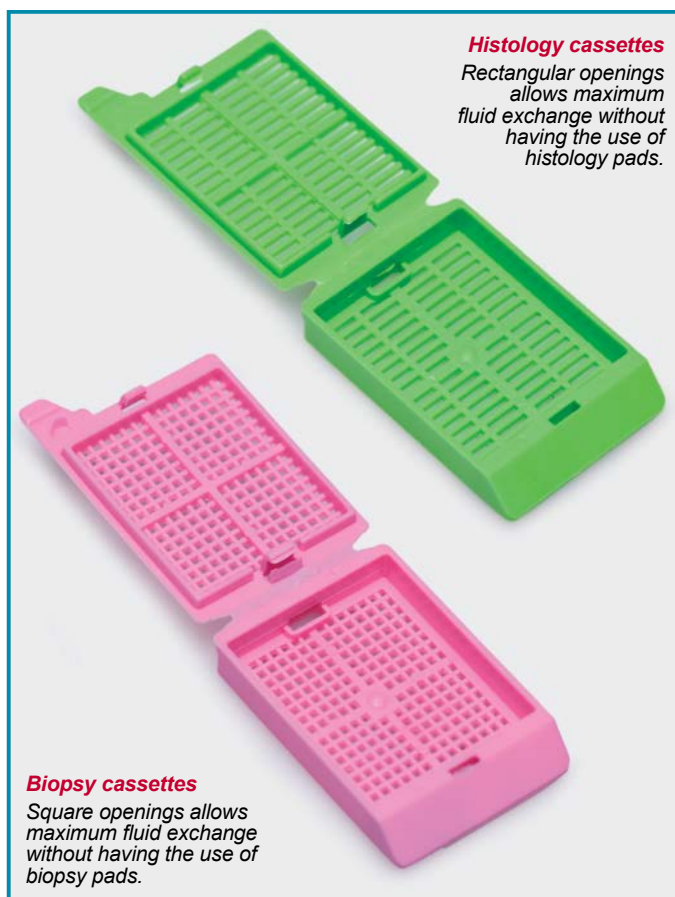

Histology cassettes
Rectangular openings allows maximum fluid exchange without having the use of histology pads.

Biopsy cassettes
Square openings allows maximum fluid exchange without having the use of biopsy pads.

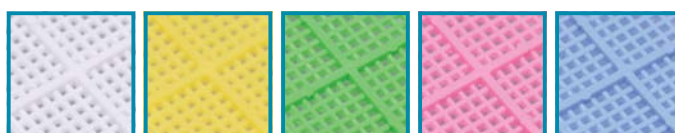



MICRO - HAEMATOCRIT TUBES

➤ Manufactured by fully automatic machines according to ISO 12772 and BS 4316-68 standards with 75 mm length and 0,2 mm wall thickness.

➤ **Alternative 2 tube types:**

➤ **Non-heparinised tubes with blue color tip.**

➤ **Heparinised tubes with red color tip.**

➤ Interior surface of heparinised tubes are covered with sodium heparinite.

catalogue number	tube type	vial quantity	box quantity
088.02.001	heparinised	100 pcs	10 vials
088.02.002	non-heparinised	100 pcs	10 vials

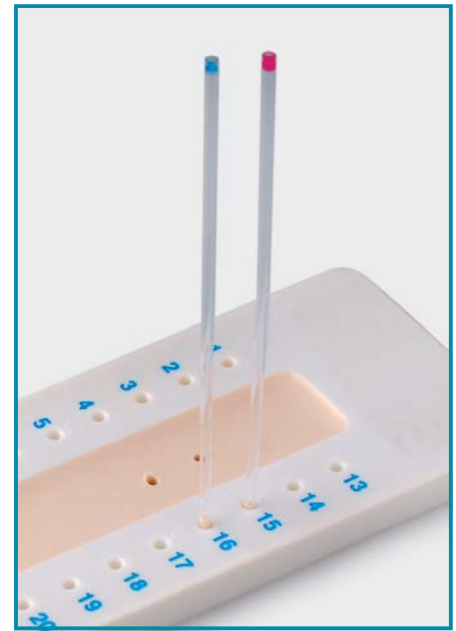

MICRO - HAEMATOCRIT TUBE WAX

➤ Offers fast and safe solutions for sealing of the micro haematocrit tube ends.

➤ Can carry 48 tubes with 2 x 24 array.

➤ Numerical index on the tray provides easy identification of tube positions

➤ This non drying sealing compound has a life time of 3 years at room conditions.

catalogue number	tube capacity	pack quantity
088.03.001	48 tubes	10 pieces



Lancets are very incisive and have very sharp edges which penetrates into the skin very easily.

BLOOD LANCETS "manual"

➤ Manufactured from medical grade stainless steel.

➤ Featured with very sharp blade end that penetrates into the skin easily without pain.

➤ Single use and gamma sterilized and individually packed.

catalogue number	pack quantity	box quantity
088.01.001	200 pieces	50 pack

BLOOD LANCETS - "automatic"

➤ Offers perfect protection since the needle is always been fully shielded "before" and "after" use.

➤ Featured with ultra sharp needle with high speed penetration of 1,8 mm depth.

➤ Single use and gamma sterilized and individually packed.

catalogue number	pack quantity	box quantity
088.02.003	100 pieces	5 packs



Twist off the protective safety cap first.



Hold the lancet firmly on the finger site



Press the release button to activate the lancet



Gently press the finger to let the blood drop out

ADAPTERS		BOSSHEADS		Burette clamps	12
2 necks	84	for stirrers	160-161	Büchner funnels	104
2 necks - 45°	84	heavy duty	51	Caps	134
2 necks - 75°	84	standard	51	Carboys	40
3 necks	84-85	swivel	51	Carrier for bottles	42
bend	83			Cell counters	198
bend - 75°	84	BOTTLES		CELL CULTURES	
bend - 90°	84	aluminium	33	cap - aluminium	29
bend- with stopcock	84	aspirator	40	cell lifter	206
delivery	85-88	dropping	41	cell scraper	206
distilling heads	85	filter	106	cell sparaders	205
expansion	82	ISO - coated glass	30	erlenmeyer	29
PTFE	87	ISO - polypropylene	31	erlenmeyer - baffed	29
receiving	88	polyethylene- for liquids	34	flasks	192
reduction	82	polyethylene- for powders	35	inaculation loop - steel	205
splash heads	85	security seal cutter	32	inoculation loop handle	205
straight	83	spraying	38	inoculation loops - HIPS	204
straight - with stopcock	83	square	32	inoculation turn table	204
tube - micro	184	wash	38-39	multiwell plate	193
with screw cap	82	water sampling	36	petri dish	193
with screw thread	82	wide neck	33		
with stopcock	83	burette	12	Cell sparaders	205
		gas wash	89		
Aluminium disc	72			CENTRIFUGE	
Aluminium foil	72	BOXES		clinical	114
Aluminium foil dispenser	72	click lock	43	mini	112
Aquadur test strips	149	cryo - cardboard	189	mini - high speed	113
Arsenic estimator	90	cryo - polycarbonate	189		
		cryo - polypropylene	188	Centrifuge tubes	44-180-181-184
AUTOCLAVES		dispenser	13-43	Ceramic triangle	49
indicator roll	119	double opening	43	Chemical pads	135
vertical	119	for nitrile gloves	133	Chromatography columns	94
		safety	123		
BAGS		slide	200	CLAMPS	
autoclavable	78	transport	42	2 jaws	50
bag latches	79-80	tube - cardboard	182	3 jaws	50
homogenization	80	vial	175	burette	12
homogenization - stand	80	with compartments	42	click lock	67
locks	79			for frame work	50
stand	78	BRUSHES		hoffman	67
with wire closure	79	burette	117	for KS joints	98
zip lock	79	dish washing	122	for vacuum filter set	160
		intensive cleaning	122	thermometer	51
BALANCES		laboratory	116-117	tube	52
0.0001 g precision	150			worm drive screw	67
0.001 g precision	150	BUCKETS			
0.01 g precision	150-151	buckets	123	Cleaning towel dispenser	122
0.1 g precision	151	ice	37	Cleaning towels	122
BASKETS		BUNSEN BURNERS		CLIPS	
basket for bottles	42	advanced	61	for NS joints	91
carrier for bottles	42	blowlamp	6		
petri dish	203	gas cartridge	61	Colony counter	203
		hose	61	Columns for chromatography	140
Beads - glass	87	meker	61		
		stabilizer	61	CONDENSERS	
BEAKERS		standard	61	allihn	92
glass	26	with gas cartridge	61	allihn - for soxhlet	94
polypropylene	26			dimroth	93
PTFE	26	BURETTES		dimroth - for soxhlet	95
stainless steel	26	bottles	12	liebig	92
with handle	27	automatic	11	spiral	93
		bellow	12		
Blood counting chambers	198	digital - manuel	18		
Blood lancets	210	schilling	12		
Blowlamp	61	straight	11		

Conductivity solution	146	Embedding cassettes	209	FUNNELS	
Containers	37			analytical	102
Cover glass forcep	58	ERLENMEYERS		büchner	104
Cover glasses	199	cell culture	29	dropping	111
Cover glasses - blood counting	198	cell culture - baffed	29	glass - plain	102
Crimpers	174	glass	28	glass - powder	102
		glass - ground neck	96	gooch	105
CRUCIBLES		screw cap	28	holders	103
alsint	65			polypropylene - plain	102
gooch	105	Estimator - arsenic	90	polypropylene - powder	102
lids	65	Estimator - water	90	polypropylene - ribbed	102
porcelain	65	Evaporating Dishes	64	separating	110
stainless steel	64	Evaporating dish tong	52	stand	103
		Extractor thimbles	95		
Crucible tongs	52	Extractors - soxhlet	95	Gas wash bottle heads	89
		Eye wash bottle stand	129	Gas wash bottles	89
CRYO		Eye wash bottles	128-129	Gaskets	105
box - cardboard	189			GHS pictograms	74
box - polycarbonate	189	FILMS		Glass beads	87
box - polypropylene	188	parafilm	70		
cryo cap inserts	185	parafilm dispenser	71	GLOVES	
Cryo tube canes	185	stretch	70	box	133
tube	185			cold protection	131
work station	188	FILTER		finger protectors	133
		membrane	167	heat protection	131
CRYSTALLIZATION DISHES				neopren	132
glass	64	Filter flasks	104	nitrile	130
stainless steel	64	Filter flasks for vacuum system	107	nitrile - chemical protection	132
		Filter paper forcep	108	safe handling	131
Cumbostion boat	64	Filter papers	108	silicone	133
Cutters	59	Finger protectors	133	thermal resistance	132
Cutting tool for tapes	74				
		FLASKS		Goggle	124
CUVETTES		2 ground neck	97	Gooch crucible	105
boxes	177	3 ground neck	97	Gooch funnel	105
glass	176-177	amber - ground neck	96	Grease	91
polystyrene	176	cell culture	192	Ground joints	82
quartz	176-177	evaporating	98	Heating Mantles	163
		filter	104		
Cylinders	10	flat bottom	27	HOMOGENIZERS	
Decappers	174	flat bottom - ground neck	97	clamp - for heavy duty	
Density bottles	154	kjehldahl	98	homogenizer	161
Desiccators	62	nitrogen	99	clamp - for light duty	
Desiccant beads	62	pear shape	98	homogenizer	161
Desk Protectors	135	receiving	98	heavy duty	161
		round bottom	27	light duty	161
DISPENSERS		round bottom - ground neck	97	rotor set	161
advanced	19	volumetric	8-9		
repetitive	18			Homogenization bag latches	80
tips	18	Flask stands	99	Homogenization bag stands	80
		Flow indicator	109	Homogenization bags	80
Dispenser boxes	13-43			Hose for bunsen burner	61
Dissecting needle set	60	FORCEPS		Ice bucket	37
Distilling heads	85	ABS	58	Imhoff cone stands	154
Distilling links	86-87	cover glasses	58	Imhoff cones	154
DO electrolyte solution	146	dissecting	58	Incinerating dishes	65
DO probe	146	filter paper	108	Inoculation loop - steel	205
Draining racks	118	general use	58	Inoculation loop handle	205
Dropping bottles	41			Inoculation loops - HIPS	204
Dropping funnels	111			Inoculation turn table	204
Drying tubes	89				
Ear muff	126			JARS	
Ear plugs	126			glass	37
				polypropylene	37
ELECTRODES				Staining jar rack	208
conductivity	146			staining jars	208
ORP	146				
pH	146				

Jerrycans	40	Micro haematocrit tubes	210	Qualitative filter papers	108
Joint grease	91	Micropipette pipetting reservoirs	20	Quantitative filter papers	108
Joint sleeves	91	Micropipette tips	22-23	Quantofix test strips	149
Knives	59	Mortars	63	Refractometers	195
LABELS		Multiwell plates	193	Rotary evaporator spare parts	101
circular form	76	Non-return valve	109	Rotary evaporators	101
rectangular form	75-77	Over boats	134	Safety box tray	123
safety	74	Over shoes	134	Safety boxes	123
Label dispenser	76	Over sleeves	134	Safety shield	126
Label remover	76	Parafilm	70	SCALPELS	
Labelling tapes	75	Parafilm dispenser	71	blades	60
Laboratory jack	49	PCR		handles	60
LABORATORY STANDS		plates	191	with safety cover	60
ABS	49	sealing film	191	SCISSORS	
horse shoe	48	sealing tape	191	disecting	59
rectangular	48	strips	190	for hose cutting	66
support rods	48	tubes	190	general use	59
triangle	48	work station	191	heavy duty	59
tripod	49	Pehanon test strips	148	SCOOPS	
Laboratory tissue	122	PEN		self standing - polypropyle	54
LED light source	126	double tip	73	self standing - polystyrene	55
Lens cleaning tissue	127	engraving	73	stainless steel	59
Lithmus paper	148	single tip	73	Screw caps	69
MAGNETIC STIRRERS		Pestles	63	Sealing tape - PTFE	91
with hot plate	156	PETRI DISH		Security seal	32
w/o hot plate	157	basket	203	Separating funnels	110
Magnetic stirring bars	158	cell culture	193	Silica-Gel	62
Magnifier	194	glass	202	Sleeves	91
Manifolds	160	polystyrene	202	SLIDES	
Masks	136	rodac	202	box cabinet	200
MECHANICAL STIRRERS		stands	203	boxes	200
light duty	160	Petri dish sealing tape	74	mailers	201
mechanical - heavy duty	160	pH - portable	144	wallet rack	201
Mechanical stirrer shafts	160	pH - table top	145	wallets - cardboard	201
Membrane filters	167	pH buffer solutions	147	slides	199
METERS	144-145	pH indicator strips	148	Soaking solution	146
MICROPIPETTES		pH paper roll	148	Soxhlet extractors	95
8 channel	21	PIPETTES		SPATULAS	
single channel	20-21	graduated	14	chattaway	53
stands	24	pasteur - glass	13	curved end	53
MICROSCOPES		pasteur - polyethylene	13	double end	53
biological	196	pasteur pipette bulb	13	flat knife	53
Image projector	196	serological	207	macro spoon	53
stereo	197	volumetric	14	macro spoon - polypropylene	57
Microscope smart tablet	197	Pipette boxes	15	micro spoon	53
MIXERS		Pipette bulb	16	poly	53
vortex	164	Pipette fillers	16	round grooved	53
		Pipette pump - electrical	17	with lid	57
		Pipette rack	15	Spectacle cabinet	127
		Pipette tray	15	Spectacles	124-125
		Pipette stands	14-15	Spectrophotometer cuvettes	176-177
		Protective suits	134	SPOONS	
		PUMPS		polystyrene	56
		vacuum & pressure	109	stainless steel	56
		water jet	109	Stabilising rings	28
				Staining jar rack	208
				Staining jars	208

product index

STANDS		Thermometer	138	TUBINGS	
eye wash bottle	129	Thermometer adapter	128	clamps - click lock	67
imhoff cone	154	Thermometer clamp	82	clamps - hoffmann	67
petri dish	203	Thimbles	95	clamps - worm drive screw	67
laboratory	48-49	TIMERS		PTFE	66
thermometer	138	electronic	143	rubber - standard	66
STIRRERS		mechanical	142	rubber - vacuum	66
magnetic - w/o hot plate	157	Tissue	122	scissor	66
magnetic - with hot plate	156	Tissue base moulds	208	silicone	66
mechanical - heavy duty	160	TLC		Tubing connectors	67
mechanical - light duty	160	separation tank	178	Ultrasonic cleaners	121
Stirrer shafts	160	spray kit	178	VACUUM	
Stirring rods	159	sprayer	178	filter set	107
STOPPERS		Tongs	52	flask	107
cellulose	68	Towel dispenser	122	manifolds	107
cork	68	Towels	122	pumps	109
flange	69	Transport box	42	support base	107
glass	69	TRAYS		Vacuum filter set	107
polypropylene	69	pipette	15	Valve	109
rubber	68	polypropylene	123	VIALS	
rubber - drilled	69	stainless steel	123	box	175
silicone	68	TUBES		crimper & decapper	174
turn over flange	68	PCR strips	190	N11 - crimp cap	172
Stopwatches	142	qPCR strips	190	N11 caps& septas	172
SYRINGES		centrifuge - glass	44	N13 - screw cap	172
glass	169	centrifuge - screw cap	180	N15 - screw cap	172
polypropylene	166	centrifuge - screw cap -		N15 caps& septas	172
serie H	169	self standing	181	N20 - crimp cap	173
serie H - removable needle	169	cryo	185	N20 caps& septas	173
serie RN - removable needle	168	cryo cap insert	185	N24 - screw cap	174
serie T	168	drying	89	N8 - screw cap	171
Syringe Filters	166	micro	184	N8 caps& septas	171
TAPES		test - glass	44	N8 insert	171
cutting tool	74	test - polypropylene	44	N9 - screw cap	171
for labelling	75	test - polystyrene	44	N9 - screw cap with insert	171
sealing - petri	74	test - polystyrene	44	N9 insert	171
sealing - PTFE	91	tube adapter - micro	184	racks	175
Tape dispenser	75	TUBE BOXES		Visitor gowns	134
Temperature probe	146	cardboard	182	VOLUMETRIC FLASKS	
Test indicator - steam sterilization	119	cryo	188-189	glass	8
TEST STRIPS		Tube clamps	52	glass - coated	8
aquadur	149	TUBE RACKS		polypropylene	9
pehanon	148	4 sides	301	trapezoidal	9
peroxide	149	dismantled	46	Wash bottles	38-39
pH indicator strips	148	epoxy coated steel	45	Watch glasses	153
pH paper roll	148	foldable	47-183	Water estimator	90
water hardness	149	hedgehod design	182	Water hardness test strips	149
Thermohygrometer	140	micro tube - 3 tier	187	WATER STILLS	
Thermohygrometer - portable	139	micro tube - base support	186	automatic	100
THERMOMETERS		micro tube - double side	187	basic	100
desk top	140-141	micro tube - foldable	186	filter	100
glass	138	PCR tube	191	WEIGHING	
max-min - humidity	141	push&hold	181	brush	153
portable	139	snappable	183	dishes - square form	152
		stainless steel	45	dishes - aluminium	152
		with silicone grips	45	dishes - diamond form	152
				papers	153
				scoops	153
				Wire gauze	48

catalogue no // page	catalogue no // page	catalogue no // page	catalogue no // page	catalogue no // page	catalogue no // page
005.01.001 → 23	011.20.100 → 21	014.01.100 → 8	019.01.025 → 11	025.01.400 → 26	028.01.052 → 96
005.01.002 → 23	011.20.200 → 21	014.01.100C → 8	019.01.050 → 11	025.01.600 → 26	028.01.053 → 96
005.01.003 → 23	011.20.901 → 21	014.01.101 → 8	019.05.010 → 11	025.01.800 → 26	028.01.100 → 96
005.01.004 → 23	011.20.905 → 21	014.01.101C → 8	019.05.025 → 11	025.01.901 → 26	028.01.101 → 96
005.01.005 → 23	011.20.910 → 21	014.01.200 → 8	019.05.050 → 11	025.01.902 → 26	028.01.102 → 96
005.01.015 → 23	011.21.010 → 21	014.01.200C → 8	020.03.010 → 12	025.01.905 → 26	028.01.103 → 96
006.03.030 → 20	011.21.050 → 21	014.01.250 → 8	020.03.025 → 12	025.01.910 → 26	028.01.250 → 96
006.03.055 → 20	011.21.200 → 21	014.01.250C → 8	020.03.050 → 12	025.03.050 → 26	028.01.251 → 96
006.03.110 → 20	011.21.300 → 21	014.01.500 → 8	020.05.010 → 12	025.03.100 → 26	028.01.252 → 96
006.05.001 → 24	013.01.005 → 8	014.01.500C → 8	020.05.025 → 12	025.03.250 → 26	028.01.300 → 96
006.11.005 → 24	013.01.005C → 8	014.01.901 → 8	020.05.050 → 12	025.03.500 → 26	028.01.500 → 96
006.11.006 → 24	013.01.010 → 8	014.01.901C → 8	020.07.010 → 12	025.03.901 → 26	028.01.501 → 96
006.12.004 → 24	013.01.010C → 8	014.01.902 → 8	020.07.025 → 12	025.04.100 → 26	028.01.502 → 96
006.12.006 → 24	013.01.020 → 8	014.01.902C → 8	020.08.001 → 12	025.04.250 → 26	028.01.901 → 96
006.13.030 → 20	013.01.020C → 8	014.03.025 → 9	021.01.001 → 14	025.04.500 → 26	028.01.902 → 96
006.13.055 → 20	013.01.025 → 8	014.03.050 → 9	021.01.002 → 14	025.04.901 → 26	028.03.050 → 28
006.13.110 → 20	013.01.025C → 8	014.03.100 → 9	021.01.005 → 14	025.05.500 → 27	028.03.100 → 28
006.15.001 → 43	013.01.026 → 8	014.03.250 → 9	021.01.010 → 14	025.05.901 → 27	028.03.250 → 28
006.15.002 → 43	013.01.026C → 8	014.03.500 → 9	021.01.020 → 14	025.05.902 → 27	028.03.500 → 28
006.15.003 → 43	013.01.050 → 8	014.03.901 → 9	021.01.025 → 14	026.01.025 → 26	028.03.901 → 28
007.01.001 → 18	013.01.050C → 8	014.13.025 → 9	021.01.050 → 14	026.01.050 → 26	028.11.053 → 96
008.06.001 → 18	013.01.051 → 8	014.13.050 → 9	021.05.001 → 14	026.01.100 → 26	028.11.103 → 96
008.06.002 → 18	013.01.051C → 8	014.13.100 → 9	021.05.002 → 14	026.01.250 → 26	028.11.252 → 96
008.06.005 → 18	013.01.100 → 8	014.13.250 → 9	021.05.003 → 14	026.01.500 → 26	028.11.502 → 96
008.06.012 → 18	013.01.100C → 8	014.13.500 → 9	021.05.004 → 14	026.01.901 → 26	028.11.901 → 96
008.06.025 → 18	013.01.101 → 8	014.13.901 → 9	021.05.005 → 14	026.01.902 → 26	028.11.902 → 96
008.06.050 → 18	013.01.101C → 8	015.01.005 → 10	021.05.010 → 14	026.02.250 → 27	029.01.050 → 27
008.06.125 → 18	013.01.150 → 8	015.01.010 → 10	021.05.011 → 14	026.02.500 → 27	029.01.100 → 27
008.06.250 → 18	013.01.150C → 8	015.01.025 → 10	021.05.015 → 14	026.02.901 → 27	029.01.250 → 27
008.06.500 → 18	013.01.200 → 8	015.01.050 → 10	021.05.020 → 14	026.02.902 → 27	029.01.500 → 27
008.12.002 → 19	013.01.200C → 8	015.01.100 → 10	021.05.025 → 14	026.02.903 → 27	029.01.901 → 27
008.12.005 → 19	013.01.250 → 8	015.01.250 → 10	021.05.050 → 14	026.03.001 → 52	029.01.902 → 27
008.12.010 → 19	013.01.250C → 8	015.01.500 → 10	021.11.001 → 14	026.03.002 → 52	029.01.904 → 27
008.12.030 → 19	013.01.300 → 8	015.01.901 → 10	021.11.002 → 14	026.03.025 → 26	029.01.906 → 27
008.12.060 → 19	013.01.300C → 8	015.01.902 → 10	021.11.005 → 14	026.03.050 → 26	029.01.910 → 27
008.12.100 → 19	013.01.400 → 8	016.01.010 → 10	021.11.010 → 14	026.03.100 → 26	029.02.050 → 27
008.15.002 → 19	013.01.400C → 8	016.01.025 → 10	021.11.020 → 14	026.03.250 → 26	029.02.100 → 27
008.15.005 → 19	013.01.500 → 8	016.01.050 → 10	021.11.025 → 14	026.03.500 → 26	029.02.250 → 27
008.15.010 → 19	013.01.500C → 8	016.01.100 → 10	021.11.050 → 14	026.03.901 → 26	029.02.500 → 27
008.15.030 → 19	013.01.901 → 8	016.01.250 → 10	021.15.001 → 14	026.03.902 → 26	029.02.901 → 27
008.15.060 → 19	013.01.901C → 8	016.01.500 → 10	021.15.002 → 14	026.04.250 → 27	029.02.902 → 27
008.15.100 → 19	013.01.902 → 8	016.01.901 → 10	021.15.005 → 14	026.04.500 → 27	029.02.904 → 27
010.01.005 → 17	013.01.902C → 8	016.05.010 → 10	021.15.010 → 14	026.04.901 → 27	029.02.906 → 27
010.01.006 → 17	013.01.905 → 8	016.05.025 → 10	021.15.015 → 14	026.04.902 → 27	029.02.910 → 27
011.01.002 → 16	013.01.910 → 8	016.05.050 → 10	021.15.020 → 14	026.04.903 → 27	029.03.001 → 52
011.01.010 → 16	013.13.001 → 9	016.05.100 → 10	021.15.025 → 14	027.01.025 → 28	029.03.002 → 52
011.01.025 → 16	013.13.002 → 9	016.05.250 → 10	022.01.001 → 14	027.01.050 → 28	029.04.001 → 99
011.02.001 → 16	013.13.003 → 9	016.05.500 → 10	022.02.001 → 15	027.01.100 → 28	029.04.002 → 99
011.02.002 → 16	013.13.004 → 9	016.05.901 → 10	022.03.001 → 15	027.01.250 → 28	029.04.003 → 99
011.02.003 → 16	013.13.005 → 9	016.06.010 → 10	022.03.002 → 15	027.01.300 → 28	029.04.004 → 99
011.02.003.3 → 16	013.13.010 → 9	016.06.025 → 10	022.03.003 → 15	027.01.500 → 28	029.04.005 → 99
011.04.001 → 16	013.13.020 → 9	016.06.050 → 10	022.03.011 → 15	027.01.901 → 28	029.14.902 → 99
011.04.003 → 16	013.13.025 → 9	016.06.100 → 10	022.04.001 → 15	027.01.902 → 28	030.01.050 → 96
011.04.005 → 16	013.13.050 → 9	016.06.250 → 10	022.04.002 → 15	027.01.903 → 28	030.01.051 → 96
011.04.010 → 16	013.15.001 → 9	016.06.500 → 10	022.06.001 → 15	027.01.905 → 28	030.01.052 → 96
011.05.002 → 20	013.15.002 → 9	016.06.901 → 10	023.01.005 → 154	027.03.100 → 28	030.01.053 → 96
011.05.010 → 20	013.15.003 → 9	016.07.010 → 10	023.01.010 → 154	027.03.250 → 28	030.01.100 → 96
011.05.020 → 20	013.15.004 → 9	016.07.025 → 10	023.01.025 → 154	027.03.500 → 28	030.01.101 → 96
011.05.050 → 20	013.15.005 → 9	016.07.050 → 10	023.01.050 → 154	027.03.901 → 28	030.01.102 → 96
011.05.100 → 20	013.15.010 → 9	016.07.100 → 10	023.01.100 → 154	027.06.100 → 29	030.01.103 → 96
011.05.200 → 20	013.15.020 → 9	016.07.250 → 10	023.02.005 → 154	027.06.101 → 29	030.01.250 → 96
011.05.901 → 20	013.15.025 → 9	016.07.500 → 10	023.02.010 → 154	027.06.250 → 29	030.01.251 → 96
011.05.905 → 20	013.15.050 → 9	016.07.901 → 10	023.02.025 → 154	027.06.500 → 29	030.01.252 → 96
011.05.910 → 20	014.01.005 → 8	017.01.010 → 11	023.02.050 → 154	027.06.901 → 29	030.01.500 → 96
011.06.002 → 20	014.01.005C → 8	017.01.025 → 11	023.02.100 → 154	027.06.902 → 29	030.01.501 → 96
011.06.010 → 20	014.01.010 → 8	017.01.050 → 11	023.03.005 → 154	027.11.048 → 28	030.01.900 → 96
011.06.020 → 20	014.01.010C → 8	017.02.010 → 11	023.03.010 → 154	027.11.056 → 28	030.01.901 → 96
011.06.050 → 20	014.01.020 → 8	017.02.025 → 11	023.03.025 → 154	027.11.061 → 28	030.01.902 → 96
011.06.100 → 20	014.01.020C → 8	017.02.050 → 11	023.03.050 → 154	027.11.074 → 28	030.01.904 → 96
011.06.200 → 20	014.01.025 → 8	018.01.010 → 11	023.03.100 → 154	027.17.250 → 29	030.02.050 → 96
011.06.901 → 20	014.01.025C → 8	018.01.025 → 11	025.01.005 → 26	027.17.500 → 29	030.02.051 → 96
011.06.905 → 20	014.01.026 → 8	018.01.050 → 11	025.01.010 → 26	027.17.901 → 29	030.02.052 → 96
011.06.910 → 20	014.01.026C → 8	018.05.001 → 12	025.01.025 → 26	027.18.250 → 29	030.02.053 → 96
011.20.002 → 21	014.01.050 → 8	018.05.002 → 12	025.01.050 → 26	027.18.500 → 29	030.02.100 → 96
011.20.010 → 21	014.01.050C → 8	018.06.001 → 12	025.01.100 → 26	027.18.901 → 29	030.02.101 → 96
011.20.020 → 21	014.01.051 → 8	018.06.002 → 12	025.01.150 → 26	028.01.050 → 96	030.02.102 → 96
011.20.050 → 21	014.01.051C → 8	019.01.010 → 11	025.01.250 → 26	028.01.051 → 96	030.02.103 → 96

product index

catalogue no // page	catalogue no // page	catalogue no // page	catalogue no // page	catalogue no // page	catalogue no // page
030.02.250 → 96	030.40.250 → 97	032.01.100 → 111	036.01.070 → 95	037.30.250W → 54	038.14.080 → 64
030.02.251 → 96	030.40.500 → 97	032.01.250 → 111	036.01.100 → 95	037.30.500B → 54	038.14.100 → 64
030.02.252 → 96	030.40.901 → 97	032.01.500 → 111	036.01.150 → 95	037.30.500W → 54	038.14.H30 → 65
030.02.500 → 96	030.41.250 → 97	032.01.901 → 111	036.01.250 → 95	037.30.901B → 54	038.14.H35 → 65
030.02.501 → 96	030.41.500 → 97	032.02.050 → 111	036.01.500 → 95	037.30.901W → 54	038.14.H40 → 65
030.02.900 → 96	030.41.901 → 97	032.02.100 → 111	037.01.050 → 153	037.32.001 → 153	038.14.H46 → 65
030.02.901 → 96	030.41.902 → 97	032.02.250 → 111	037.01.060 → 153	037.33.001 → 153	038.14.H51 → 65
030.02.902 → 96	030.42.250 → 97	032.02.500 → 111	037.01.070 → 153	037.35.025B → 55	038.14.H60 → 65
030.02.904 → 96	030.43.250 → 97	032.02.901 → 111	037.01.080 → 153	037.35.025W → 55	038.14.L30 → 65
030.12.053 → 96	030.43.500 → 97	032.03.050 → 111	037.01.100 → 153	037.35.050B → 55	038.14.L35 → 65
030.12.103 → 96	030.43.901 → 97	032.03.100 → 111	037.01.125 → 153	037.35.050W → 55	038.14.L40 → 65
030.12.252 → 96	030.44.250 → 97	032.03.250 → 111	037.01.150 → 153	037.35.100B → 55	038.14.L45 → 65
030.12.501 → 96	030.44.500 → 97	032.03.500 → 111	037.01.200 → 153	037.35.100W → 55	038.14.L50 → 65
030.12.901 → 96	030.44.901 → 97	032.03.901 → 111	037.02.254 → 153	037.35.150B → 55	038.14.L60 → 65
030.24.050 → 97	030.44.902 → 97	032.03.160 → 92	037.02.305 → 153	037.35.150W → 55	038.14.L70 → 65
030.24.100 → 97	030.45.250 → 97	033.11.250 → 92	037.02.353 → 153	037.35.250B → 55	038.14.M35 → 65
030.24.250 → 97	030.45.500 → 97	033.11.252 → 92	037.02.357 → 153	037.35.250W → 55	038.14.M40 → 65
030.25.100 → 97	030.45.901 → 97	033.11.253 → 92	037.02.402 → 153	037.35.500B → 55	038.14.M45 → 65
030.25.250 → 97	030.46.250 → 97	033.11.400 → 92	037.02.408 → 153	037.35.500W → 55	038.14.M50 → 65
030.25.500 → 97	030.46.500 → 97	033.11.402 → 92	037.02.503 → 153	037.36.001 → 57	038.14.M60 → 65
030.25.901 → 97	030.46.901 → 97	033.11.403 → 92	037.02.508 → 153	037.36.002 → 56	038.14.M70 → 65
030.26.100 → 97	030.47.250 → 97	033.12.160 → 92	037.02.603 → 153	037.36.010 → 56	038.14.M82 → 65
030.26.250 → 97	030.47.500 → 97	033.12.250 → 92	037.02.803 → 153	037.36.025W → 55	038.17.001 → 64
030.26.500 → 97	030.47.901 → 97	033.12.252 → 92	037.04.001 → 153	037.36.050W → 55	038.18.065 → 63
030.26.901 → 97	030.47.902 → 97	033.12.253 → 92	037.04.002 → 153	037.36.100W → 55	038.18.085 → 63
030.27.100 → 97	030.49.010 → 98	033.12.400 → 92	037.04.003 → 153	037.36.150W → 55	038.18.110 → 63
030.27.250 → 97	030.49.025 → 98	033.12.402 → 92	037.05.005 → 152	037.36.250W → 55	038.18.125 → 63
030.27.500 → 97	030.49.050 → 98	033.12.403 → 92	037.05.030 → 152	037.36.500W → 55	038.18.150 → 63
030.27.901 → 97	030.49.100 → 98	033.13.160 → 92	037.05.100 → 152	038.02.065 → 63	038.19.035 → 65
030.27.902 → 97	030.49.250 → 98	033.13.250 → 92	037.06.005 → 152	038.02.090 → 63	038.19.043 → 65
030.28.100 → 97	030.52.050 → 98	033.13.252 → 92	037.06.030 → 152	038.02.130 → 63	038.19.046 → 65
030.28.250 → 97	030.52.100 → 98	033.13.253 → 92	037.06.100 → 152	038.02.150 → 63	038.19.052 → 65
030.28.500 → 97	030.52.250 → 98	033.13.400 → 92	037.07.001 → 153	038.02.180 → 63	038.19.060 → 65
030.28.901 → 97	030.55.100 → 98	033.13.402 → 92	037.07.002 → 153	038.03.115 → 63	038.19.068 → 65
030.28.902 → 97	030.55.250 → 98	033.13.403 → 92	037.07.003 → 153	038.03.135 → 63	038.20.025 → 65
030.29.100 → 97	030.55.500 → 98	033.14.160 → 92	037.08.050 → 56	038.03.150 → 63	038.20.046 → 65
030.29.250 → 97	030.55.901 → 98	033.14.250 → 92	037.08.075 → 56	038.03.175 → 63	038.20.055 → 65
030.29.500 → 97	030.56.100 → 98	033.14.252 → 92	037.08.100 → 56	038.03.210 → 63	038.21.040 → 65
030.29.901 → 97	030.56.250 → 98	033.14.253 → 92	037.08.120 → 56	038.05.001 → 52	038.21.050 → 65
030.29.902 → 97	030.56.500 → 98	033.14.400 → 92	037.09.007 → 152	038.06.250 → 52	038.21.060 → 65
030.30.050 → 97	030.56.901 → 98	033.14.402 → 92	037.09.100 → 152	038.06.300 → 52	039.01.200 → 62
030.30.100 → 97	030.57.100 → 98	033.14.403 → 92	037.09.250 → 152	038.06.400 → 52	039.01.250 → 62
030.30.250 → 97	030.57.250 → 98	033.15.160 → 93	037.11.007 → 152	038.07.050 → 63	039.01.300 → 62
030.31.100 → 97	030.57.500 → 98	033.15.253 → 93	037.11.100 → 152	038.07.075 → 63	039.02.200 → 62
030.31.250 → 97	030.57.750 → 98	033.15.403 → 93	037.11.250 → 152	038.07.100 → 63	039.02.250 → 62
030.31.500 → 97	030.57.901 → 98	033.16.160 → 93	037.15.005 → 152	038.07.125 → 63	039.02.300 → 62
030.31.901 → 97	030.58.025 → 99	033.16.253 → 93	037.15.030 → 152	038.07.150 → 63	039.05.200 → 62
030.32.100 → 97	030.58.050 → 99	033.16.403 → 93	037.15.100 → 152	038.08.050 → 63	039.05.250 → 62
030.32.250 → 97	030.58.100 → 99	033.17.160 → 93	037.16.005 → 152	038.08.075 → 63	039.05.300 → 62
030.32.500 → 97	030.58.250 → 99	033.17.163 → 93	037.16.030 → 152	038.08.100 → 63	039.06.200 → 62
030.32.901 → 97	030.59.050 → 99	033.17.250 → 93	037.16.100 → 152	038.08.125 → 63	039.06.250 → 62
030.33.100 → 97	030.59.100 → 99	033.17.253 → 93	037.19.007 → 152	038.08.150 → 63	039.06.300 → 62
030.33.250 → 97	030.59.250 → 99	033.17.400 → 93	037.19.100 → 152	038.09.060 → 63	039.07.200 → 62
030.33.500 → 97	030.59.500 → 99	033.17.403 → 93	037.19.250 → 152	038.09.070 → 63	039.07.250 → 62
030.33.901 → 97	030.59.901 → 99	033.18.160 → 93	037.21.007 → 152	038.09.080 → 63	039.07.300 → 62
030.33.902 → 97	030.60.003 → 87	033.18.163 → 93	037.21.100 → 152	038.09.100 → 63	039.08.100 → 79
030.34.100 → 97	030.60.004 → 87	033.18.250 → 93	037.21.250 → 152	038.09.120 → 63	039.08.150 → 79
030.34.250 → 97	030.60.005 → 87	033.18.253 → 93	037.23.070 → 152	038.11.060 → 64	039.08.220 → 79
030.34.500 → 97	030.60.006 → 87	033.18.400 → 93	037.23.085 → 152	038.11.080 → 64	039.08.300 → 79
030.34.901 → 97	031.02.050 → 110	033.18.403 → 93	037.23.110 → 152	038.11.100 → 64	039.12.200 → 62
030.34.902 → 97	031.02.100 → 110	035.11.030 → 94	037.24.045 → 152	038.11.125 → 64	039.12.250 → 62
030.35.100 → 97	031.02.250 → 110	035.11.070 → 94	037.24.055 → 152	038.11.160 → 64	039.12.300 → 62
030.35.250 → 97	031.02.500 → 110	035.11.250 → 94	037.24.065 → 152	038.12.060 → 64	039.16.001 → 62
030.35.500 → 97	031.02.901 → 110	035.11.500 → 94	037.25.100 → 152	038.12.080 → 64	039.20.001 → 78
030.35.901 → 97	031.02.902 → 110	035.12.030 → 94	037.30.002B → 54	038.12.100 → 64	039.20.002 → 78
030.35.902 → 97	031.04.050 → 110	035.12.070 → 94	037.30.002W → 54	038.12.125 → 64	039.20.003 → 78
030.36.250 → 97	031.04.100 → 110	035.12.250 → 94	037.30.005B → 54	038.12.160 → 64	039.21.001 → 79
030.37.250 → 97	031.04.250 → 110	035.12.500 → 94	037.30.005W → 54	038.13.A30 → 65	039.21.002 → 79
030.37.500 → 97	031.04.500 → 110	035.13.030 → 95	037.30.010B → 54	038.13.A41 → 65	039.21.003 → 79
030.37.901 → 97	031.04.901 → 110	035.13.070 → 95	037.30.010W → 54	038.13.A48 → 65	039.21.004 → 79
030.38.250 → 97	031.04.902 → 110	035.13.250 → 95	037.30.025B → 54	038.13.A54 → 65	039.21.005 → 79
030.38.500 → 97	031.06.050 → 110	035.13.500 → 95	037.30.025W → 54	038.13.A60 → 65	039.23.001 → 80
030.38.901 → 97	031.06.100 → 110	035.14.030 → 95	037.30.050B → 54	038.13.A66 → 65	039.23.002 → 80
030.38.902 → 97	031.06.250 → 110	035.14.070 → 95	037.30.050W → 54	038.13.S35 → 64	039.23.003 → 80
030.39.250 → 97	031.06.500 → 110	035.14.250 → 95	037.30.100B → 54	038.13.S45 → 64	039.30.001 → 78
030.39.500 → 97	031.06.901 → 110	035.14.500 → 95	037.30.100W → 54	038.13.S50 → 64	039.30.002 → 78
030.39.901 → 97	032.01.050 → 111	036.01.030 → 95	037.30.250B → 54	038.14.060 → 64	039.30.003 → 78

catalogue no // page	catalogue no // page	catalogue no // page	catalogue no // page	catalogue no // page	catalogue no // page
039.30.004 → 78	043.01.074 → 105	047.10.150 → 53	049.09.180 → 161	051.21.002 → 69	052.12.003 → 66
039.30.005 → 78	043.01.121 → 105	047.10.200 → 53	049.09.250 → 48	051.21.003 → 69	052.12.004 → 66
039.34.105 → 79	043.01.122 → 105	047.10.300 → 53	049.09.250 → 160	051.21.004 → 69	052.12.005 → 66
039.34.150 → 79	043.01.123 → 105	047.18.001 → 56	049.09.320 → 48	051.21.005 → 69	052.12.006 → 66
039.35.075 → 79	043.01.124 → 105	047.18.002 → 56	050.01.001 → 61	051.21.006 → 69	052.12.007 → 66
039.35.145 → 79	043.01.501 → 105	047.32.150 → 57	050.01.002 → 61	051.21.007 → 69	052.12.008 → 66
039.35.200 → 80	043.01.502 → 105	047.32.180 → 57	050.01.003 → 61	051.21.008 → 69	052.13.001 → 66
040.01.100 → 104	043.01.503 → 105	047.32.210 → 57	050.01.004 → 61	051.21.009 → 69	052.13.002 → 66
040.01.250 → 104	043.01.504 → 105	047.33.150 → 57	050.02.001 → 61	051.21.010 → 69	052.13.003 → 66
040.01.500 → 104	043.02.031 → 105	047.33.180 → 57	050.03.001 → 61	051.22.001 → 68	052.13.004 → 66
040.01.901 → 104	043.02.032 → 105	047.33.210 → 57	050.04.001 → 49	051.22.002 → 68	052.13.005 → 66
040.01.902 → 104	043.02.033 → 105	048.01.105 → 58	050.04.002 → 49	051.22.003 → 68	052.13.006 → 66
040.02.100 → 104	043.02.034 → 105	048.01.115 → 58	050.05.150 → 49	051.22.004 → 68	052.13.007 → 66
040.02.250 → 104	043.02.051 → 105	048.01.130 → 58	050.05.200 → 49	051.22.005 → 68	052.13.008 → 66
040.02.500 → 104	043.02.052 → 105	048.01.145 → 58	050.06.001 → 48	051.22.006 → 68	052.13.009 → 66
040.02.901 → 104	043.02.053 → 105	048.01.160 → 58	050.07.050 → 49	051.22.007 → 68	052.15.010B → 67
040.02.902 → 104	043.02.054 → 105	048.01.200 → 58	050.07.060 → 49	051.22.008 → 68	052.15.010O → 67
040.05.001 → 104	043.03.001 → 107	048.01.250 → 58	050.08.075 → 61	051.22.009 → 68	052.15.010R → 67
040.05.002 → 104	043.03.002 → 107	048.01.300 → 58	050.08.100 → 61	051.22.010 → 68	052.15.015B → 67
040.05.003 → 104	043.03.003 → 107	048.02.115 → 58	050.09.001 → 61	051.22.011 → 68	052.15.015O → 67
040.05.004 → 104	043.03.004 → 107	048.02.130 → 58	051.03.001 → 69	051.22.012 → 68	052.15.015R → 67
040.06.001 → 105	043.03.005 → 107	048.02.145 → 58	051.03.002 → 69	051.22.013 → 68	052.15.020B → 67
040.10.001 → 109	043.03.006 → 107	048.02.160 → 58	051.03.003 → 69	051.22.014 → 68	052.15.020O → 67
040.10.005 → 109	043.03.007 → 107	048.03.001 → 58	051.03.004 → 69	051.22.015 → 68	052.15.020R → 67
041.01.040 → 102	043.05.101 → 106	048.03.002 → 58	051.03.005 → 69	051.22.016 → 68	052.16.012 → 67
041.01.060 → 102	043.05.103 → 106	048.04.001 → 108	051.03.006 → 69	051.22.017 → 68	052.16.016 → 67
041.01.080 → 102	043.05.106 → 106	048.06.001 → 59	051.03.007 → 69	051.22.018 → 68	052.16.020 → 67
041.01.100 → 102	043.06.001 → 106	048.06.002 → 59	051.04.001 → 69	051.22.019 → 68	052.16.025 → 67
041.01.120 → 102	043.06.011 → 106	048.07.105 → 58	051.04.002 → 69	051.22.020 → 68	052.17.012 → 67
041.01.150 → 102	043.08.015 → 105	048.07.115 → 58	051.04.003 → 69	051.22.021 → 68	052.17.020 → 67
041.02.040 → 102	043.08.030 → 105	048.07.130 → 58	051.04.004 → 69	051.22.022 → 68	052.17.030 → 67
041.02.060 → 102	043.08.050 → 105	048.07.150 → 58	051.04.005 → 69	051.23.001 → 68	052.18.001 → 109
041.02.080 → 102	043.20.001 → 154	048.07.160 → 58	051.04.006 → 69	051.23.002 → 68	052.22.006 → 67
041.02.100 → 102	043.20.002 → 154	048.07.200 → 58	051.04.007 → 69	051.23.003 → 68	052.22.008 → 67
041.02.120 → 102	043.22.002 → 154	048.08.105 → 58	051.08.010 → 69	051.23.004 → 68	052.22.010 → 67
041.02.150 → 102	045.01.001 → 50	048.08.115 → 58	051.08.012 → 69	051.23.005 → 68	052.23.006 → 67
041.03.080 → 102	045.03.001 → 50	048.08.130 → 58	051.08.014 → 69	051.23.006 → 68	052.23.008 → 67
041.04.080 → 102	045.04.001 → 50	048.10.110 → 58	051.08.019 → 69	051.23.007 → 68	052.23.010 → 67
041.05.040 → 102	045.06.001 → 50	048.11.110 → 58	051.08.024 → 69	051.23.008 → 68	052.24.006 → 67
041.05.060 → 102	046.01.001 → 51	048.22.130 → 59	051.08.029 → 69	051.23.009 → 68	052.24.008 → 67
041.05.080 → 102	046.01.002 → 51	048.22.160 → 59	051.09.45B → 69	051.23.010 → 68	052.24.010 → 67
041.05.100 → 102	046.05.001 → 51	048.23.130 → 59	051.09.45G → 69	051.23.011 → 68	052.25.006 → 67
041.05.120 → 102	046.05.002 → 51	048.23.160 → 59	051.09.45R → 69	051.23.012 → 68	052.25.008 → 67
041.05.150 → 102	046.07.001 → 50	048.24.130 → 59	051.09.45Y → 69	051.23.013 → 68	052.25.010 → 67
041.07.065 → 102	047.01.120 → 53	048.24.160 → 59	051.10.001 → 69	051.23.014 → 68	052.30.001 → 60
041.07.080 → 102	047.01.150 → 53	048.25.130 → 59	051.10.002 → 69	051.23.015 → 68	055.01.001 → 142
041.07.100 → 102	047.01.180 → 53	048.26.130 → 59	051.10.003 → 69	051.23.016 → 68	055.02.001 → 142
041.07.120 → 102	047.01.210 → 53	048.30.130 → 59	051.10.004 → 69	051.23.017 → 68	055.03.001 → 142
041.07.150 → 102	047.01.250 → 53	048.30.160 → 59	051.10.005 → 69	051.23.018 → 68	055.04.001 → 142
041.08.060 → 102	047.01.300 → 53	048.30.200 → 59	051.11.001 → 69	051.23.019 → 68	056.01.001 → 142
041.08.080 → 102	047.02.150 → 53	048.31.001 → 59	051.11.002 → 69	051.23.020 → 68	056.02.001 → 143
041.08.100 → 102	047.02.180 → 53	048.50.001 → 60	051.11.003 → 69	051.23.021 → 68	056.03.001 → 143
041.08.120 → 102	047.02.210 → 53	048.50.002 → 60	051.11.004 → 69	051.23.022 → 68	056.04.001 → 143
042.01.070 → 104	047.03.150 → 53	048.50.003 → 60	051.11.005 → 69	051.24.009 → 29	057.01.010 → 158
042.01.090 → 104	047.03.180 → 53	048.51.010 → 60	051.20.001 → 68	051.26.001 → 68	057.01.015 → 158
042.01.110 → 104	047.03.210 → 53	048.51.011 → 60	051.20.002 → 68	051.26.002 → 68	057.01.020 → 158
042.02.070 → 104	047.05.001 → 54	048.51.021 → 60	051.20.003 → 68	051.26.003 → 68	057.01.025 → 158
042.02.090 → 104	047.05.002 → 54	049.01.130 → 48	051.20.004 → 68	051.26.004 → 68	057.01.030 → 158
042.02.110 → 104	047.06.150 → 53	049.01.150 → 48	051.20.005 → 68	051.26.005 → 68	057.01.035 → 158
042.03.040 → 103	047.06.180 → 53	049.01.200 → 48	051.20.006 → 68	051.26.006 → 68	057.01.040 → 158
042.03.060 → 103	047.06.210 → 53	049.03.115 → 48	051.20.007 → 68	051.26.007 → 68	057.01.045 → 158
042.03.080 → 103	047.07.130 → 53	049.03.150 → 48	051.20.008 → 68	051.26.008 → 68	057.01.050 → 158
042.03.100 → 103	047.07.150 → 53	049.04.175 → 49	051.20.009 → 68	052.08.002 → 66	057.01.060 → 158
042.04.040 → 103	047.07.185 → 53	049.05.060 → 64	051.20.010 → 68	052.10.001 → 66	057.01.070 → 158
042.04.060 → 103	047.07.210 → 53	049.05.100 → 64	051.20.011 → 68	052.10.002 → 66	057.01.080 → 158
042.04.080 → 103	047.07.250 → 53	049.05.150 → 64	051.20.012 → 68	052.10.003 → 66	057.02.001 → 159
042.04.100 → 103	047.07.300 → 53	049.05.300 → 64	051.20.013 → 68	052.10.004 → 66	057.02.002 → 159
042.05.001 → 103	047.08.150 → 53	049.05.900 → 64	051.20.014 → 68	052.10.005 → 66	057.02.101 → 42
042.06.001 → 103	047.08.180 → 53	049.06.004 → 48	051.20.015 → 68	052.10.006 → 66	057.02.101 → 158
042.06.010 → 103	047.08.210 → 53	049.06.005 → 48	051.20.016 → 68	052.10.007 → 66	057.03.200 → 158
043.01.051 → 105	047.09.100 → 53	049.06.006 → 48	051.20.017 → 68	052.10.008 → 66	057.03.250 → 158
043.01.052 → 105	047.09.130 → 53	049.07.004 → 48	051.20.018 → 68	052.11.001 → 66	057.03.300 → 158
043.01.053 → 105	047.09.150 → 53	049.07.005 → 48	051.20.019 → 68	052.11.002 → 66	057.04.251 → 159
043.01.054 → 105	047.09.180 → 53	049.07.006 → 48	051.20.020 → 68	052.11.003 → 66	057.05.020 → 158
043.01.071 → 105	047.09.210 → 53	049.08.070 → 64	051.20.021 → 68	052.11.004 → 66	057.05.025 → 158
043.01.072 → 105	047.10.075 → 53	049.08.085 → 64	051.20.022 → 68	052.12.001 → 66	057.05.030 → 158
043.01.073 → 105	047.10.100 → 53	049.08.110 → 64	051.21.001 → 69	052.12.002 → 66	057.05.035 → 158

product index

catalogue no // page	catalogue no // page	catalogue no // page	catalogue no // page	catalogue no // page	catalogue no // page
057.05.040 → 158	061.09.500 → 35	061.28.500 → 36	062.40.902 → 123	064.11.011 → 82	065.43.004 → 84
057.06.037 → 158	061.09.901 → 35	061.28.901 → 36	062.40.905 → 123	064.11.012 → 82	065.43.005 → 84
058.01.001 → 70	061.10.050 → 33	061.29.040 → 37	062.42.910 → 123	064.12.001 → 82	065.43.006 → 84
058.01.002 → 70	061.10.100 → 33	061.29.105 → 37	062.42.915 → 123	064.12.002 → 82	065.44.001 → 84
058.02.001B → 71	061.10.250 → 33	061.29.370 → 37	062.42.920 → 123	064.12.003 → 82	065.44.002 → 84
058.02.001P → 71	061.10.500 → 33	061.29.720 → 37	062.50.500 → 39	064.12.004 → 82	065.44.003 → 84
058.02.001R → 71	061.10.901 → 33	061.29.901 → 37	062.51.500 → 39	064.12.005 → 82	065.44.004 → 84
058.02.002 → 72	061.11.050 → 33	061.41.500 → 34	062.51.501 → 39	064.12.006 → 82	065.44.005 → 84
058.02.101 → 71	061.11.100 → 33	061.41.901 → 34	062.51.502 → 39	064.12.007 → 82	065.45.001 → 85
058.03.001 → 70	061.11.250 → 33	061.41.902 → 34	062.52.500 → 39	064.12.008 → 82	065.45.002 → 85
058.04.001 → 72	061.11.500 → 33	061.41.905 → 34	062.53.500 → 39	064.12.009 → 82	065.45.005 → 85
058.05.080 → 72	061.11.901 → 33	061.42.125 → 35	062.54.500 → 39	064.12.010 → 82	065.46.001 → 85
058.05.100 → 72	061.13.001 → 37	061.42.250 → 35	062.55.500 → 39	064.12.011 → 82	065.46.002 → 85
058.05.125 → 72	061.13.002 → 37	061.42.500 → 35	062.56.500 → 39	064.12.012 → 82	065.46.005 → 85
058.05.150 → 72	061.13.004 → 37	061.42.901 → 35	062.57.500 → 39	065.10.001 → 194	065.46.006 → 85
058.06.001 → 91	061.13.006 → 37	061.42.902 → 35	062.58.500 → 39	065.10.004 → 194	065.47.001 → 85
058.07.001 → 74	061.13.008 → 37	061.42.911 → 35	062.60.901 → 123	065.10.006 → 194	065.47.003 → 85
059.02.001 → 138	061.14.025 → 33	061.46.901 → 34	062.60.902 → 123	065.18.001 → 84	065.48.001 → 85
059.02.002 → 138	061.14.060 → 33	061.46.902 → 34	062.60.903 → 123	065.18.002 → 84	065.48.005 → 85
059.02.003 → 138	061.14.120 → 33	061.47.050 → 34	062.60.905 → 123	065.18.003 → 84	065.52.014 → 86
059.02.004 → 138	061.14.300 → 33	061.47.125 → 34	062.60.909 → 123	065.18.004 → 84	065.52.029 → 86
059.03.003 → 141	061.14.600 → 33	061.47.250 → 34	062.60.918 → 123	065.19.141 → 82	065.53.014 → 86
059.03.004 → 141	061.14.901 → 33	061.47.500 → 34	062.61.909 → 123	065.19.142 → 82	065.53.029 → 86
059.05.001 → 138	061.14.906 → 33	061.47.901 → 34	062.61.914 → 123	065.19.291 → 82	065.54.014 → 86
060.01.001 → 139	061.14.912 → 33	062.02.100 → 41	062.66.001 → 42	065.19.292 → 82	065.54.029 → 86
060.01.002 → 139	061.14.931 → 33	062.03.100 → 41	062.66.004 → 42	065.19.293 → 82	065.55.001 → 86
060.01.003 → 140	061.15.100 → 31	062.04.100 → 41	062.66.500 → 42	065.21.014 → 82	065.55.002 → 86
060.02.001 → 140	061.15.250 → 31	062.04.101 → 41	062.66.901 → 42	065.21.029 → 82	065.55.003 → 86
060.03.001 → 140	061.15.500 → 31	062.05.05B → 38	062.66.902 → 42	065.22.014 → 83	065.55.004 → 86
060.03.002 → 139	061.15.901 → 31	062.05.05G → 38	062.80.901 → 123	065.22.029 → 83	065.56.001 → 86
060.04.001 → 51	061.15.902 → 31	062.05.05R → 38	062.80.903 → 123	065.23.014 → 83	065.56.002 → 86
061.01.100 → 30	061.16.100 → 31	062.05.05Y → 38	062.80.905 → 123	065.23.029 → 83	065.56.003 → 86
061.01.100C → 30	061.16.250 → 31	062.05.100 → 38	062.80.912 → 123	065.24.014 → 83	065.56.004 → 86
061.01.250 → 30	061.16.500 → 31	062.05.250 → 38	062.80.925 → 123	065.24.029 → 83	065.57.001 → 87
061.01.250C → 30	061.16.901 → 31	062.05.500 → 38	063.01.010 → 82	065.25.014 → 83	065.57.002 → 87
061.01.500 → 30	061.16.902 → 31	062.05.901 → 38	063.01.012 → 82	065.25.029 → 83	065.57.003 → 87
061.01.500C → 30	061.17.100 → 31	062.08.250 → 38	063.01.014 → 82	065.26.014 → 83	065.57.004 → 87
061.01.901 → 30	061.17.250 → 31	062.08.500 → 38	063.01.019 → 82	065.26.029 → 83	065.58.001 → 87
061.01.901C → 30	061.17.500 → 31	062.09.05B → 39	063.01.024 → 82	065.27.014 → 83	065.58.002 → 87
061.01.902 → 30	061.17.901 → 31	062.09.05G → 39	063.01.029 → 82	065.27.029 → 83	065.58.003 → 87
061.01.902C → 30	061.17.902 → 31	062.09.05R → 39	063.01.034 → 82	065.28.014 → 83	065.58.004 → 87
061.01.903 → 30	061.18.100 → 31	062.09.05Y → 39	063.01.045 → 82	065.28.029 → 83	065.60.100 → 89
061.01.905 → 30	061.18.250 → 31	062.10.010 → 41	063.02.010 → 82	065.29.014 → 83	065.60.150 → 89
061.01.910 → 30	061.18.500 → 31	062.10.015 → 41	063.02.012 → 82	065.29.029 → 83	065.62.100 → 89
061.01.920 → 30	061.18.901 → 31	062.10.020 → 41	063.02.014 → 82	065.30.014 → 88	065.62.130 → 89
061.02.100 → 30	061.18.902 → 31	062.10.030 → 41	063.02.019 → 82	065.30.029 → 88	065.62.180 → 89
061.02.100C → 30	061.20.001 → 32	062.11.250 → 38	063.02.024 → 82	065.31.014 → 88	065.63.100 → 89
061.02.250 → 30	061.21.125 → 36	062.11.500 → 38	063.02.029 → 82	065.31.029 → 88	065.63.130 → 89
061.02.250C → 30	061.21.250 → 36	062.12.050 → 41	063.02.034 → 82	065.32.014 → 88	065.63.180 → 89
061.02.500 → 30	061.21.500 → 36	062.12.100 → 41	063.02.045 → 82	065.32.029 → 88	065.66.125 → 89
061.02.500C → 30	061.21.901 → 36	062.13.050 → 41	063.04.010 → 91	065.33.014 → 88	065.66.250 → 89
061.02.901 → 30	061.22.125 → 36	062.13.100 → 41	063.04.012 → 91	065.33.029 → 88	065.66.500 → 89
061.02.901C → 30	061.22.250 → 36	062.21.902 → 40	063.04.014 → 91	065.34.014 → 85	065.66.901 → 89
061.02.902 → 30	061.22.500 → 36	062.21.903 → 40	063.04.019 → 91	065.34.029 → 85	065.67.001 → 89
061.02.902C → 30	061.22.901 → 36	062.21.905 → 40	063.04.024 → 91	065.36.014 → 87	065.67.002 → 89
061.02.903 → 30	061.23.125 → 36	062.21.910 → 40	063.04.029 → 91	065.36.019 → 87	065.67.011 → 89
061.02.905 → 30	061.23.250 → 36	062.21.920 → 40	063.04.034 → 91	065.36.024 → 87	065.67.022 → 89
061.02.910 → 30	061.23.500 → 36	062.21.930 → 40	063.04.045 → 91	065.36.029 → 87	065.70.001 → 90
061.02.920 → 30	061.23.901 → 36	062.27.905 → 40	063.05.001 → 98	065.37.014 → 84	065.71.001 → 90
061.07.050 → 32	061.24.125 → 36	062.27.910 → 40	063.14.014 → 91	065.37.029 → 84	066.10.001 → 94
061.07.100 → 32	061.24.250 → 36	062.27.920 → 40	063.14.019 → 91	065.38.014 → 84	066.10.003 → 94
061.07.250 → 32	061.24.500 → 36	062.28.905 → 40	063.14.024 → 91	065.38.029 → 84	066.10.004 → 94
061.07.500 → 32	061.24.901 → 36	062.28.910 → 40	063.14.029 → 91	065.39.014 → 88	066.11.001 → 94
061.07.901 → 32	061.25.125 → 36	062.28.920 → 40	063.14.034 → 91	065.39.029 → 88	066.11.002 → 94
061.07.902 → 32	061.25.250 → 36	062.30.002 → 78	063.14.045 → 91	065.40.014 → 88	066.11.003 → 94
061.08.050 → 32	061.25.500 → 36	062.36.910 → 43	063.16.001 → 91	065.40.029 → 88	066.11.004 → 94
061.08.100 → 32	061.25.901 → 36	062.36.920 → 43	063.16.002 → 91	065.41.014 → 85	066.11.005 → 94
061.08.250 → 32	061.26.125 → 36	062.36.930 → 43	064.11.001 → 82	065.41.019 → 85	067.30.001 → 90
061.08.500 → 32	061.26.250 → 36	062.39.900 → 43	064.11.002 → 82	065.41.024 → 85	069.03.005 → 126
061.08.901 → 32	061.26.500 → 36	062.39.901 → 43	064.11.003 → 82	065.41.029 → 85	069.03.175 → 129
061.08.902 → 32	061.26.901 → 36	062.39.902 → 43	064.11.004 → 82	065.42.001 → 84	069.03.660 → 128
061.09.0B1 → 32	061.27.125 → 36	062.39.903 → 43	064.11.005 → 82	065.42.002 → 84	069.04.001 → 126
061.09.0G1 → 32	061.27.250 → 36	062.39.905 → 43	064.11.006 → 82	065.42.003 → 84	069.04.002 → 126
061.09.0R1 → 32	061.27.500 → 36	062.39.907 → 43	064.11.007 → 82	065.42.004 → 84	069.04.175 → 129
061.09.0Y1 → 32	061.27.901 → 36	062.39.910 → 43	064.11.008 → 82	065.43.001 → 84	069.04.660 → 128
061.09.125 → 35	061.28.125 → 36	062.39.913 → 43	064.11.009 → 82	065.43.002 → 84	069.05.001 → 129
061.09.250 → 35	061.28.250 → 36	062.40.901 → 123	064.11.010 → 82	065.43.003 → 84	069.05.175 → 129

catalogue no // page	catalogue no // page	catalogue no // page	catalogue no // page	catalogue no // page	catalogue no // page
069.05.660 → 128	076.02.000B → 200	078.12.002 → 180	080.01.004B → 186	080.65.003 → 127	092.19.001 → 37
071.01.002 → 118	076.02.000O → 200	078.12.003 → 180	080.01.004P → 186	080.65.004 → 122	092.19.004 → 37
071.01.003 → 118	076.02.000P → 200	078.12.004 → 180	080.01.004R → 186	080.66.001 → 135	092.22.101W → 189
071.01.004 → 118	076.02.000R → 200	078.12.005 → 181	080.01.005B → 186	080.66.002 → 135	092.22.102W → 189
071.01.101 → 118	076.02.000W → 200	078.12.006 → 181	080.01.005P → 186	080.66.003 → 135	092.35.003 → 185
071.01.102 → 118	076.02.001B → 200	078.12.007 → 180	080.01.005R → 186	080.66.005 → 135	093.01.001G → 189
071.02.001 → 116	076.02.001O → 200	078.12.008 → 180	080.01.006B → 186	080.66.006 → 135	093.01.001P → 189
071.02.002 → 116	076.02.001P → 200	078.12.009 → 181	080.01.006P → 186	080.67.001 → 122	093.01.001R → 189
071.02.003 → 116	076.02.001R → 200	078.20.015W → 182	080.01.006R → 186	080.76.001 → 135	093.01.002B → 189
071.02.004 → 116	076.02.001W → 200	078.20.050W → 182	080.01.007B → 186	081.01.060 → 202	094.01.001 → 166
071.02.005 → 116	076.02.002B → 200	079.01.001B → 46	080.01.007P → 186	081.01.080 → 202	094.01.002 → 166
071.02.006 → 116	076.02.002O → 200	079.01.001O → 46	080.01.007R → 186	081.01.100 → 202	094.01.003 → 166
071.03.001 → 116	076.02.002P → 200	079.01.001R → 46	080.01.101 → 186	081.01.120 → 202	094.01.005 → 166
071.05.001 → 117	076.02.002R → 200	079.01.001W → 46	080.04.001 → 52	081.01.150 → 202	094.01.006 → 166
071.05.002 → 117	076.02.002W → 200	079.01.002B → 46	080.04.002 → 52	081.02.061 → 202	094.01.007 → 166
071.05.003 → 117	076.02.012B → 200	079.01.002O → 46	080.05.001 → 133	081.02.091 → 202	094.01.008 → 166
071.05.004 → 117	076.02.012O → 200	079.01.002R → 46	080.05.002 → 133	081.02.092 → 202	094.02.001 → 166
071.05.005 → 117	076.02.012P → 200	079.01.002W → 46	080.06.002B → 187	081.02.093 → 202	094.02.002 → 166
071.06.001 → 122	076.02.012R → 200	079.01.003B → 46	080.06.002P → 187	081.02.094 → 202	094.02.003 → 166
071.06.002 → 122	076.02.012W → 200	079.01.003O → 46	080.06.002R → 187	081.02.121 → 202	094.02.004 → 166
071.07.003 → 122	076.02.101 → 200	079.01.003R → 46	080.10.101 → 131	081.02.161 → 202	094.02.005 → 166
071.10.001 → 118	076.05.001 → 201	079.01.003W → 46	080.10.201 → 131	081.02.191 → 202	094.02.006 → 166
073.01.001 → 208	076.05.002 → 201	079.01.004B → 46	080.11.001 → 131	081.02.192 → 202	094.02.007 → 166
073.03.001 → 208	076.05.003 → 201	079.01.004O → 46	080.13.001 → 131	081.02.193 → 202	094.02.008 → 166
073.05.001 → 208	076.05.004 → 201	079.01.004R → 46	080.15.001 → 130	081.02.194 → 202	094.03.001 → 166
073.06.001 → 208	077.01.000 → 44	079.01.004W → 46	080.15.002 → 130	081.02.221 → 202	094.03.002 → 166
074.01.001 → 209	077.01.001 → 44	079.01.005B → 46	080.15.003 → 130	081.04.060 → 202	094.03.003 → 166
074.01.002 → 209	077.01.002 → 44	079.01.005O → 46	080.15.004 → 130	081.04.160 → 202	094.03.005 → 166
074.01.003 → 209	077.01.003 → 44	079.01.005R → 46	080.16.001 → 130	081.10.001 → 204	094.03.006 → 166
074.01.004 → 209	077.01.004 → 44	079.01.005W → 46	080.16.002 → 130	081.13.060 → 203	094.03.007 → 166
074.01.005 → 209	077.01.005 → 44	079.01.006B → 46	080.16.003 → 130	081.13.090 → 203	094.03.008 → 166
074.02.001 → 209	077.01.006 → 44	079.01.006O → 46	080.16.004 → 130	081.14.001 → 198	094.04.001 → 166
074.03.001 → 209	077.01.007 → 44	079.01.006R → 46	080.17.001 → 133	081.14.002 → 198	094.04.002 → 166
074.03.002 → 209	077.01.008 → 44	079.01.006W → 46	080.17.002 → 133	081.20.001 → 203	094.04.003 → 166
074.03.003 → 209	077.01.021 → 44	079.01.101 → 45	080.18.001 → 133	082.01.001 → 204	094.04.004 → 166
074.03.004 → 209	077.01.031 → 44	079.01.102 → 45	080.18.002 → 133	082.01.002 → 204	094.04.005 → 166
074.03.005 → 209	077.02.001 → 44	079.01.103 → 45	080.21.007 → 132	082.01.003 → 204	094.04.006 → 166
074.04.001 → 209	077.02.002 → 44	079.01.104 → 45	080.21.008 → 132	082.02.001 → 205	094.04.007 → 166
074.04.002 → 209	077.02.003 → 44	079.01.105 → 45	080.21.009 → 132	082.02.003 → 205	094.04.008 → 166
074.04.003 → 209	077.02.004 → 44	079.01.106 → 45	080.22.007 → 132	082.03.001 → 205	094.05.001 → 166
074.04.004 → 209	077.02.005 → 44	079.02.001 → 45	080.22.008 → 132	082.03.003 → 205	094.05.002 → 166
074.04.005 → 209	077.02.006 → 44	079.02.002 → 45	080.22.009 → 132	083.13.001 → 13	094.05.003 → 166
074.07.001 → 208	077.03.001 → 44	079.02.003 → 45	080.23.007 → 132	083.13.002 → 13	094.05.005 → 166
074.07.002 → 208	077.03.002 → 44	079.03.001B → 47	080.23.008 → 132	083.13.005 → 13	094.05.006 → 166
074.07.003 → 208	077.04.001 → 44	079.03.001O → 47	080.23.009 → 132	083.13.010 → 13	094.05.007 → 166
075.00.001 → 199	077.04.002 → 44	079.03.001R → 47	080.26.007 → 132	083.13.025 → 13	094.05.008 → 166
075.00.002 → 199	077.04.003 → 44	079.03.001W → 47	080.26.009 → 132	083.13.050 → 13	094.06.006 → 166
075.00.003 → 199	077.04.004 → 44	079.03.002B → 47	080.26.010 → 215	083.13.100 → 13	094.07.001 → 166
075.00.004 → 199	077.04.005 → 44	079.03.002O → 47	080.40.001 → 125	084.01.001 → 13	094.07.002 → 166
075.00.005 → 199	077.04.006 → 44	079.03.002R → 47	080.40.002B → 124	084.01.002 → 13	094.07.003 → 166
075.00.006 → 199	078.01.001 → 44	079.03.002W → 47	080.40.002G → 124	084.02.001 → 13	094.07.005 → 166
075.00.007 → 199	078.01.002 → 44	079.03.003B → 47	080.40.002P → 124	084.02.003 → 13	094.07.006 → 166
075.01.001 → 199	078.02.001 → 180	079.03.003O → 47	080.40.002R → 124	084.03.001 → 13	094.07.007 → 166
075.01.002 → 199	078.02.002 → 180	079.03.003R → 47	080.40.003 → 124	084.05.001 → 13	094.07.008 → 166
075.01.003 → 199	078.02.003 → 180	079.03.003W → 47	080.40.004 → 125	084.22.001 → 13	094.08.006 → 166
075.01.004 → 199	078.02.004 → 180	079.03.004B → 47	080.40.007 → 124	084.22.003 → 13	094.11.005 → 168
075.01.005 → 199	078.02.005 → 181	079.03.004O → 47	080.40.010 → 126	087.02.001 → 37	094.11.010 → 168
075.01.006 → 199	078.02.006 → 181	079.03.004R → 47	080.40.011 → 125	087.02.002 → 37	094.11.025 → 168
075.01.007 → 199	078.02.007 → 180	079.03.004W → 47	080.40.021 → 125	088.01.001 → 210	094.11.050 → 168
075.02.005 → 199	078.02.008 → 180	079.03.005B → 47	080.40.101 → 127	088.02.001 → 210	094.11.100 → 168
075.02.006 → 199	078.02.009 → 181	079.03.005O → 47	080.40.102 → 127	088.02.002 → 210	094.11.250 → 168
075.02.007 → 199	078.03.001 → 184	079.03.005R → 47	080.41.001 → 136	088.02.003 → 210	094.11.500 → 168
075.02.008 → 199	078.03.002 → 184	079.03.005W → 47	080.41.002 → 136	088.03.001 → 210	094.12.005 → 168
075.02.009 → 199	078.03.003 → 184	079.03.006B → 183	080.41.003 → 136	089.03.012B → 191	094.12.010 → 168
075.03.001 → 198	078.03.004 → 184	079.04.001 → 183	080.44.001 → 136	089.03.012P → 191	094.12.025 → 168
075.03.002 → 198	078.03.021 → 184	079.08.015B → 182	080.44.101 → 136	089.03.012R → 191	094.12.050 → 168
075.04.001 → 198	078.03.022 → 184	079.08.015L → 182	080.45.001 → 136	089.03.013 → 191	094.12.100 → 168
075.05.001 → 199	078.03.023 → 184	079.08.050B → 182	080.45.101 → 136	091.11.102 → 185	094.12.250 → 168
075.05.002 → 199	078.03.024 → 184	079.08.050L → 182	080.50.001 → 134	091.11.105 → 185	094.12.500 → 168
075.05.003 → 199	078.05.002 → 184	079.11.016 → 45	080.50.011 → 134	091.15.001 → 185	094.13.005 → 168
075.05.004 → 199	078.05.005 → 184	080.01.001 → 46	080.51.003 → 134	091.15.002 → 185	094.13.010 → 168
076.01.001B → 201	078.05.022 → 184	080.01.002B → 175	080.51.004 → 134	091.15.003 → 185	094.13.025 → 168
076.01.001G → 201	078.05.025 → 184	080.01.002P → 175	080.51.005 → 134	091.15.004 → 185	094.13.050 → 168
076.01.001R → 201	078.05.105 → 184	080.01.002R → 175	080.51.006 → 134	091.15.005 → 185	094.13.100 → 168
076.01.001W → 201	078.06.015B → 181	080.01.003B → 187	080.53.001 → 134	092.01.001B → 188	094.13.250 → 168
076.01.001Y → 201	078.06.050B → 181	080.01.003P → 187	080.53.021 → 134	092.01.001P → 188	094.13.500 → 168
076.01.003 → 201	078.12.001 → 180	080.01.003R → 187	080.65.002 → 122	092.01.001R → 188	094.21.005 → 168

product index

catalogue no // page	catalogue no // page	catalogue no // page	catalogue no // page	catalogue no // page	catalogue no // page
094.21.010 → 168	094.92.050 → 169	099.04.004 → 74	105.01.125 → 108	605.01.103 → 101	621.11.103 → 161
094.21.025 → 168	095.00.001 → 171	099.04.005 → 74	105.02.110 → 108	605.01.104 → 101	621.11.250 → 161
094.21.050 → 168	095.00.002 → 171	099.05.009 → 76	105.02.125 → 108	605.01.105 → 101	622.01.001 → 164
094.21.100 → 168	095.01.001 → 171	099.05.013 → 76	105.03.110 → 108	605.01.106 → 101	622.02.001 → 164
094.21.250 → 168	095.01.002 → 171	099.05.019 → 76	105.03.125 → 108	605.01.107 → 101	622.03.001 → 164
094.21.500 → 168	095.02.001 → 172	099.05.025 → 76	105.11.110 → 108	605.01.108 → 101	622.11.001 → 109
094.22.005 → 168	095.02.002 → 172	099.05.109 → 76	105.11.125 → 108	605.01.109 → 101	622.12.001 → 109
094.22.010 → 168	095.03.001 → 173	099.05.113 → 76	105.12.110 → 108	605.01.110 → 101	623.01.004 → 100
094.22.025 → 168	095.03.002 → 173	099.06.024 → 77	105.12.125 → 108	605.01.111 → 101	623.01.008 → 100
094.22.050 → 168	095.03.003 → 173	099.06.033 → 77	105.13.110 → 108	605.01.112 → 101	623.02.004 → 100
094.22.100 → 168	095.03.004 → 173	099.06.038 → 77	105.13.125 → 108	605.01.113 → 101	623.02.008 → 100
094.22.250 → 168	095.03.011 → 174	099.06.124 → 77	106.01.110 → 108	605.01.114 → 101	623.11.110 → 100
094.22.500 → 168	095.03.012 → 174	099.06.133 → 77	106.01.125 → 108	605.01.115 → 101	908.B01.1000 → 147
094.31.005 → 168	095.05.001 → 172	099.07.033 → 77	106.02.110 → 108	608.01.101 → 80	908.B02.1000 → 147
094.31.010 → 168	095.05.002 → 172	099.07.038 → 77	106.02.125 → 108	608.01.102 → 80	908.B03.1000 → 147
094.31.020 → 168	095.06.001 → 172	099.11.001 → 74	106.03.110 → 108	608.11.100 → 163	908.B04.1000 → 147
094.31.050 → 168	095.06.002 → 172	099.11.002 → 74	106.03.125 → 108	608.11.250 → 163	908.B05.1000 → 147
094.31.100 → 168	095.06.003 → 172	099.11.003 → 74	106.11.110 → 108	608.11.500 → 163	908.B06.1000 → 147
094.31.250 → 168	095.95.001 → 175	099.11.004 → 74	106.11.125 → 108	608.11.901 → 163	908.B07.1000 → 147
094.32.005 → 168	095.95.002 → 175	099.12.001 → 74	106.12.110 → 108	608.11.902 → 163	908.B08.1000 → 147
094.32.010 → 168	096.00.001 → 171	099.12.002 → 74	106.12.125 → 108	608.12.100 → 163	908.B09.1000 → 147
094.32.020 → 168	096.00.002 → 171	099.12.003 → 74	106.13.110 → 108	608.12.250 → 163	908.B10.1000 → 147
094.32.050 → 168	096.01.001 → 171	099.12.004 → 74	106.13.125 → 108	608.12.500 → 163	908.B11.1000 → 147
094.32.100 → 168	096.01.002 → 171	099.13.001 → 74	107.40.140 → 108	608.12.901 → 163	T-B-010 → 22
094.32.250 → 168	096.02.001 → 172	099.13.002 → 74	107.58.158 → 108	610.01.005 → 17	T-B-011 → 22
094.41.005 → 169	096.02.002 → 172	099.13.003 → 74	108.01.016 → 178	610.01.006 → 17	T-B-1000 → 22
094.41.010 → 169	096.03.001 → 173	099.13.004 → 74	108.02.001 → 178	613.01.001 → 156	T-B-10000 → 22
094.41.025 → 169	096.05.001 → 173	099.14.001 → 74	108.02.002 → 178	613.01.102 → 156	T-B-1250 → 22
094.41.050 → 169	096.05.003 → 172	099.14.003 → 74	120.11.025 → 192	613.03.001 → 157	T-B-200 → 22
094.41.100 → 169	096.05.004 → 172	099.15.001 → 74	120.11.075 → 192	613.05.001 → 157	T-B-300 → 22
094.41.250 → 169	096.05.011 → 174	099.15.002 → 74	120.11.175 → 192	613.06.001 → 156	T-B-5000 → 22
094.41.500 → 169	096.05.012 → 174	099.15.003 → 74	120.12.025 → 192	613.07.001 → 157	TF-010 → 22
094.41.901 → 169	097.01.011 → 174	099.15.004 → 74	120.12.075 → 192	613.21.001 → 196	TF-011 → 22
094.41.902 → 169	097.01.020 → 174	099.16.002 → 74	120.12.175 → 192	613.22.001 → 197	TF-100 → 22
094.41.905 → 169	097.02.011 → 174	099.16.004 → 74	120.13.035 → 193	613.31.001 → 196	TF-1000 → 22
094.41.910 → 169	097.02.020 → 174	099.17.001 → 74	120.13.060 → 193	613.41.001 → 197	TF-1250 → 22
094.42.005 → 169	097.03.001 → 173	099.17.003 → 74	120.13.090 → 193	615.01.001 → 160	TF-200 → 22
094.42.010 → 169	097.03.002 → 173	099.18.001 → 74	121.01.001 → 206	615.01.012 → 160	TF-300 → 22
094.42.025 → 169	097.04.001 → 173	099.18.002 → 74	121.11.023 → 206	615.01.101 → 160	TF-50 → 22
094.42.050 → 169	097.04.002 → 173	099.18.003 → 74	121.12.030 → 206	615.01.103 → 160	TF-R-S-010 → 22
094.42.100 → 169	097.05.106 → 171	099.18.004 → 74	122.11.006 → 193	616.01.001 → 144	TF-R-S-011 → 22
094.42.250 → 169	097.05.107 → 171	099.19.001 → 74	122.11.012 → 193	616.01.101 → 146	TF-R-S-100 → 22
094.42.500 → 169	097.05.108 → 171	099.19.003 → 74	122.11.024 → 193	616.01.103 → 146	TF-R-S-1000 → 22
094.42.901 → 169	097.05.109 → 171	099.50.001 → 76	122.11.048 → 193	616.01.104 → 146	TF-R-S-1250 → 22
094.42.902 → 169	097.05.110 → 171	099.60.001 → 76	122.11.096 → 193	616.02.002 → 144	TF-R-S-200 → 22
094.42.905 → 169	097.05.111 → 171	101.01.001 → 148	122.11.196 → 193	616.02.101 → 146	TF-R-S-300 → 22
094.42.910 → 169	098.01.001 → 176	101.01.002 → 148	123.01.002 → 190	616.02.102 → 146	TF-R-S-50 → 22
094.51.005 → 169	098.01.002 → 176	101.02.001 → 148	123.01.028 → 190	616.11.001 → 145	T-R-010 → 22
094.51.010 → 169	098.01.003 → 176	101.02.002 → 148	123.01.096 → 191	616.11.101 → 146	T-R-011 → 22
094.51.025 → 169	098.01.004 → 176	101.02.003 → 148	123.02.018 → 190	616.11.102 → 146	T-R-1000 → 22
094.51.050 → 169	098.01.005 → 176	101.03.001 → 119	123.02.028 → 190	616.11.103 → 146	T-R-1250 → 22
094.51.100 → 169	098.01.006 → 176	101.03.003 → 149	123.02.096 → 191	616.11.104 → 146	T-R-200 → 22
094.51.250 → 169	098.01.007 → 177	101.03.004 → 149	123.03.028 → 190	616.11.105 → 146	T-R-300 → 22
094.51.500 → 169	098.01.008 → 177	101.03.005 → 149	124.01.001 → 191	616.11.107 → 146	T-R-S-010 → 22
094.51.901 → 169	098.01.009 → 177	101.04.003 → 148	502.04.500 → 147	616.11.108 → 146	T-R-S-011 → 22
094.51.902 → 169	098.01.010 → 177	101.13.003 → 149	502.04.901 → 147	616.12.001 → 145	T-R-S-1000 → 22
094.51.905 → 169	098.01.011 → 177	101.13.004 → 149	502.07.500 → 147	618.21.001 → 195	T-R-S-10000 → 22
094.51.910 → 169	098.01.012 → 177	101.13.005 → 149	502.07.901 → 147	618.22.001 → 195	T-R-S-1250 → 22
094.52.005 → 169	098.02.001 → 176	101.14.003 → 148	502.10.500 → 147	618.23.001 → 195	T-R-S-200 → 22
094.52.010 → 169	098.02.002 → 176	102.28.080 → 95	502.10.901 → 147	618.24.001 → 195	T-R-S-300 → 22
094.52.025 → 169	098.03.001B → 177	102.30.080 → 95	601.02.024 → 119	618.25.001 → 195	T-R-S-5000 → 22
094.52.050 → 169	098.03.001P → 177	102.33.080 → 95	602.01.001 → 162	618.32.001 → 195	
094.52.100 → 169	098.03.001R → 177	102.33.094 → 95	602.01.101 → 162	618.41.001 → 195	
094.52.250 → 169	098.03.002B → 177	102.34.120 → 95	602.02.001 → 162	621.01.101 → 121	
094.52.500 → 169	098.03.002P → 177	104.01.001 → 167	602.31.001 → 150	621.05.001 → 120	
094.52.901 → 169	098.03.002R → 177	104.01.002 → 167	602.31.002 → 150	621.05.003 → 120	
094.52.902 → 169	099.01.001 → 73	104.01.003 → 167	602.31.003 → 150	621.05.006 → 120	
094.52.905 → 169	099.01.002 → 73	104.01.004 → 167	602.31.006 → 151	621.05.010 → 120	
094.52.910 → 169	099.01.003 → 73	104.01.005 → 167	602.31.007 → 151	621.05.015 → 120	
094.91.002 → 166	099.01.006 → 73	104.01.006 → 167	602.32.001 → 151	621.05.022 → 120	
094.91.005 → 166	099.02.001 → 75	104.01.007 → 167	603.01.001 → 112	621.05.028 → 120	
094.91.010 → 166	099.02.002 → 75	104.01.008 → 167	603.02.001 → 113	621.06.003 → 121	
094.91.020 → 166	099.02.011 → 75	104.01.009 → 167	603.05.001 → 114	621.06.006 → 121	
094.92.001 → 169	099.03.050 → 75	104.01.010 → 167	603.11.001 → 203	621.06.010 → 121	
094.92.005 → 169	099.03.072 → 75	104.01.011 → 167	605.01.001 → 101	621.08.001 → 127	
094.92.010 → 169	099.03.090 → 75	104.01.012 → 167	605.01.101 → 101	621.11.001 → 161	
094.92.020 → 169	099.04.001 → 74	105.01.110 → 108	605.01.102 → 101	621.11.050 → 161	



ISOLAB

Laborgeräte GmbH

ISOLAB
Laborgeräte GmbH

Bahnhofstrasse 10, D97877 Wertheim - Germany
Tel: +49 9342 912355 / Fax: +49 9342 912357
info@isolab.de

www.isolab.de