

ISOLAB

Laborgeräte GmbH



English Edition



ISOLAB

Laborgeräte GmbH

*one stop shopping
for laboratories*

- 
- glasswares* ✓
 - consumables* ✓
 - equipments* ✓
 - instruments* ✓
 - chemicals* ✓

2023 - 2025



*Dear customer,
We are proud to present our
new, colourful and cheerful
catalogue to your taste.
Main “highlights” of our new catalogue are;*

*We added hundreds of
new products that were carefully
selected to ease your daily work.*



*Products are categorised with
different section colors according
to their areas of utilization.*

*New designed product and
catalogue number indexes offer
easy and fast access to products.*



*We are now offering a wide range
of chemicals and reagents with a
perfect price & quality correlation.*

highlights
our goals, mission and vision

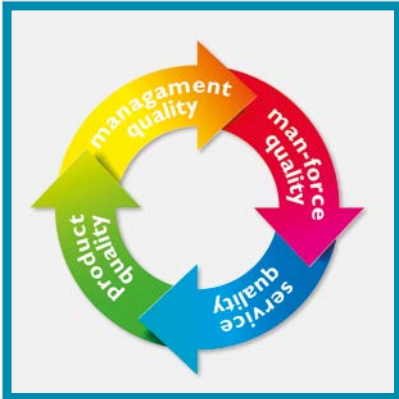

For us, the only important factor is quality. Our product quality, service quality, man-force quality, and management quality will never change.



Our compass always directs us to perfection. German sensibility and perfectionism are two main components of our entire business life.



We deny the word "impossible". We have no place in our vocabulary such as "impossible". In contrast, we have opportunity, solution, flexibility.



We consider our customers as the sole judge in this game that we have been playing with enthusiasm. Customer satisfaction is our only criteria.



We always wanted the word "trust" to gleam next to our name. And it is actually what happened. Our belief is that everything starts with trust.



It is our sincere belief that we were all born from the same mother. We are always respectful to the environment and the world we live in.



Everyday we embrace new ideas. Each morning we spend the first hours for implementing new ideas to our business.

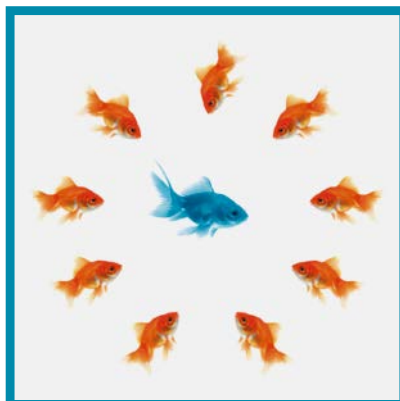

We differentiate ourselves from the ordinary. We always try to create new ideas and strategies for being a pioneer in our field of activity.



For many years now, we have been working for science extending beyond boundaries. We have been successfully exporting to 110 countries in the world.

highlights plastic injection production



ISO LAB is also a well known plastic labware manufacturer. Latest technologies approved production techniques and high capacity machinery park are held to serve the best **sterile** and **non sterile** products.

ISO LAB plastic production consists of experienced staff, high capacity injection moulding technology and premium grade raw material.

Most of the ISO LAB plastic products are certified with **CE - Invitro Diagnostic Directive**, council directive 98/79/EC, concerning in vitro diagnostic instruments.

Raw materials are carefully chosen according to their **MFI** (melt flow index) value, **OIT** (oxidative induction time) value, density and humidity.

highlights plastic blowing production



Thanks to the latest technology, ISO LAB became one of the best Plastic Blowing Producer in labware industry.

Fully automated blowing machines, European made moulds and auxiliary, Premium grade raw material and experienced staff, provide a stable and seamless labwares, such as; bottles, pipettes etc.

ISO LAB is using very sensitive control units, such as patented parison controls from 300 different points.

This helps to control the wall thickness in all sections of a product and resulting a continuous quality level.

highlights plastic sterile production



ISO LAB sterile production plants are well equipped clean rooms with **HEPA filters** and positive pressure areas which are supplied with air locked doors.

Clean rooms are validated according to international **DIN** and **ISO** standards. In order to avoid any contamination through human contact, the entire process is automated.

Raw material is automatically fed from silos to moulding machines, through vacuum loaders.

Clean room staff is equipped with appropriate, protective clothes, in order to diminish the contamination risks.

highlights quality control & certification

ISO LAB Laboratory GmbH
Testing protocols used in ISO LAB Quality Assurance

material specs & pressure test

Tubes are manufactured from virgin Polypropylene, caps are manufactured from virgin High density Polyethylene. Their materials are heavy metal free (acc. to CONCD reg.) color compounds and meet USP and Class II requirements for sterile containers and closures. Products are produced in the ISO class 100000 cleanroom. The production of all has been certified and is in accordance with standard operating procedures as well as reflected in the GMP changeover records. This product lot has been gamma irradiated and is available for the detection of test kit components with sterility assurance level of SAL 10⁻⁶.

Endotoxin (Pyrogen) RNase/DNase testing

Products have been tested and have met the criteria established in ANSI/ASME E7 72-2008B (2008 revision) Endotoxin - Test methods, endotoxin testing and alternative to heat testing with results less than 0.1 EU/ml. Products in this lot have also been tested and are free of any detectable RNAse/DNase contamination. The production of all has been certified and is in accordance with standard operating procedures and has been released by quality assurance for the following characteristics:

Product sterilization

Manufactured in a class 10,000 sterile room under gamma-free aseptic conditions and then re-sterilized by gamma radiation. The product lot has been gamma irradiated in a dosage level range between 12-25 kGy and dose-uniformly released based on the distribution of radioactive measurements with clarity assurance level of SAL 10⁻⁶.

Endotoxin (Pyrogen) detection

Samples are extracted in endotoxin-free water and tested for endotoxins using the kinetic turbidimetric method of the Limulus Amoebocyte Lysate (LAL) test according to the USP standard with minimum detection level 0.05 EU/ml.

Nucleic acid detection

Samples are tested to detect endotoxin containing lot of 7.5 kb Plasmid (pUC19) with a probe containing 5' and 3' primer. The reaction time is 15 minutes at 65°C. The reaction is followed by a 15-minute incubation at 72°C to amplify the product. The resulting reaction must not show any level of amplification of the DNA and RNA fragments.

DNA contamination

Samples are extracted with sterile, DNA-free water. A portion of extract is added to a PCR reaction containing thermostable polymerase, a primer set to amplify a mammalian gene, and dNTPs. Negative control reactions and positive control reactions (containing 1 µg of human genomic DNA) are also included. All reactions are incubated for 40 cycles, after which the results are visualized by agarose gel electrophoresis. The absence of PCR signal in the sample reactions indicates the product is free of DNA contamination.

ISO LAB Laboratory GmbH
CERTIFICATE OF COMPLIANCE AND QUALITY

| | |
|-----------------|--|
| Product Name | |
| Category Number | |
| Product Lot No | |
| Material Used | |
| Production Date | |
| Expiration Date | |

This package contains a gamma irradiated high quality product manufactured in a PCR-clean and gamma-free Class 10,000 clean room (according to EN ISO 14644 - 1 & EN ISO 14644 - 2) environment.

This certificate is issued to confirm that this lot of products had been manufactured and tested under a registered and audited ISO 9001 quality system and conforms the below mentioned material specs and passed all tests successfully.

| Test Procedure | Results |
|------------------------|---------|
| Leak Test | Pass |
| Container Test | Pass |
| Visual with/without | Pass |
| Packaging | Pass |
| Endotoxin (Pyrogen) | Free |
| Human DNA - DNase | Free |
| RNase - PCR inhibition | Free |

ISO LAB Laboratory GmbH



The biotech industry needs certification for the plastics they use. The market trends indicate a need for **DNase**, **RNase** and pyrogen-free products.

ISO LAB certified plastic products are a result of an ongoing quality control process.

The process begins with the inspection of raw materials to monitoring the final product and ends with testing each lot after production for contaminants.

product groups classified by colors

volumetric measurement & liquid handling (001 - 024)

laboratory consumables & labware (025 - 080)

distillation & filtration & separation & sample preparation (081 - 114)

cleaning & safety & protection & sterilization (115 - 136)

density & temperature & time & pH & weight measurement (137 - 154)

stirring & mixing & shaking & heating & cooling (155 - 164)

chromatography & spectroscopy (165 - 178)

life sciences & microscopy & microbiology (179 - 210)

how to use QR code



Based on the principles of innovative approach we, as ISOLAB Family, are dedicated to giving you the best user experience and technical support when you need.

On our brand new product catalogue, we launched a very useful feature, which allows you to explore ISOLAB World with a 360° view!

Now you can start to scan product QR codes on relevant product pages and take a 360° look at ISOLAB products, for a 360° scene of quality.



Scan barcodes on our catalogue by your smartphone easily in all platforms or just click in the digital catalogue.

SCAN

Please scan barcodes in the catalogue by using QR code scanner on your smartphone.

CLICK

Please kindly click in the link shown in your QR code scanner or click directly in your digital catalogue.

WATCH

You can see the details of the products on youtube.



Please subscribe our youtube channel



Scan here for further details about ISOLAB



ISOLAB
Laborgeräte GmbH



volumetric measurement & liquid handling

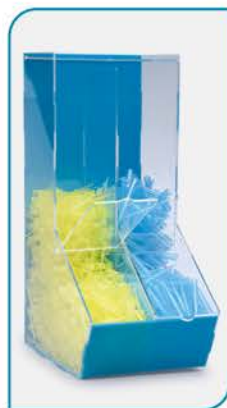
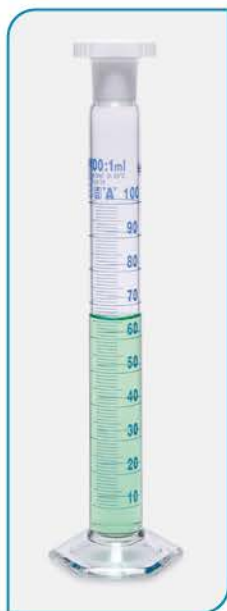
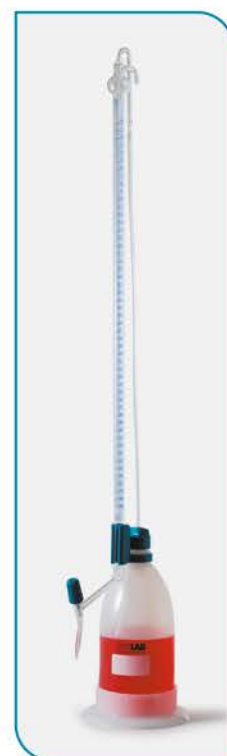

volumetric measurement & liquid handling

blank production



State of the art automatic welding and attaching machines are used for connecting the glass parts to each other.

ISOLAB is one of the few manufacturers that produces its own blank products.

Glass tubes are blown by highly skilled blowers to ensure the uniform wall thickness, exact shape and dimensions according to DIN standards.

After rigorous controls, all blanks are sent to tunnel furnaces where the stress on the blanks is eliminated under controlled heating and cooling process.

This process ensures the optimum mechanical stability and inhibits the effect of temperature fluctuations.



Glass tubes are blown by highly skilled blowers to ensure the uniform wall thickness, exact dimensions according to DIN standards.

joint production

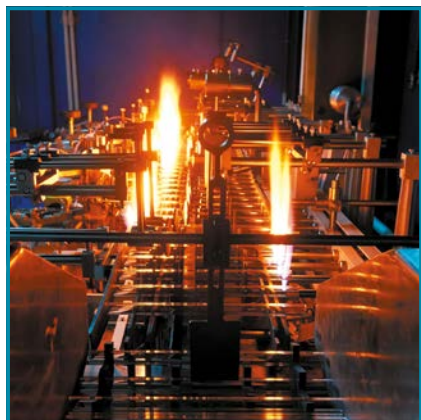

All joints are manufactured by automatic forming machines for consistent quality and guaranteed uniformity.

ISOLAB manufactures all joints with automatic machines with guaranteed uniformity.

During the grinding process, only diamond tools are used to ensure perfect results.

The taper of the joints are tested with precise taper angle control machine to ensure the taper quality.

This process ensures ending up with accurately tapered, smoothly finished, absolutely leak-proof and interchangeable ground joints.

The tightness also tested with vacuum test machines.



Grinding steps are performed by diamond reamers assuring best results with highest precision.

calibrated tubing production



Glass tubings are slowly and gradually heated up to half-melting level. Then they are shrunk around steel rods with precise diameter.

Most of the burette manufacturers use ordinary tubings which are more tolerant in terms of wall thickness and inside diameter.

ISOLAB burette tubings are manufactured by using vacuum technology to maintain inside diameter of the burette tubings uniform all over their length.

First tubings are slowly and gradually heated up to half-melting level.

Then they are shrunk around steel rods with precise diameter under vacuum condition for uniform wall thickness and diameter.



Burette tubings are manufactured by using vacuum technology to maintain diameter of the burette tubings uniform all over their length.

volumetric measurement & liquid handling

printing process

ISOLAB uses the most advanced printing machines for achieving the highest printing quality.

These machines guarantee high contrast and sharp printing providing precise reading.

All used screen stencils are stretchable.

The stretchable screen stencils easily stretched to match the calibration marks so that the volume precision is maintained at all volume levels.

Specially formulated blue, white or amber colored enamels are used during printing process.

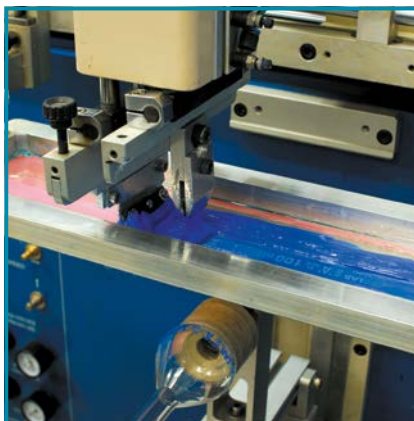

Only high contrasted and fine printing allows precise reading of scaled products such as cylinders, burettes, pipettes etc.

ISOLAB DIN 'A' In 20°C 2000 ml : 1450 NS 2932-9090 3.3 DE-M 19

According to DIN standards the information listed hereunder is required to be printed on the bodies of products.

- Brand name
- Nominal capacity
- Class degree
- Calibration temperature
- Matching standards
- Possible error limits
- Batch numbers
- Production date
- Warnings, etc

annealing process

Furnace process is the last step to reach a perfect product.

In order to achieve, stress-free products with highest level of printing quality precise controlled gradual heating and cooling is essential.

At **ISOLAB**, all heating and annealing steps are carried with state-of-art temperature controlled tunnel furnaces.

For these reasons all **ISOLAB** glassware are stress-free, mechanically strong and ever lasting printed.

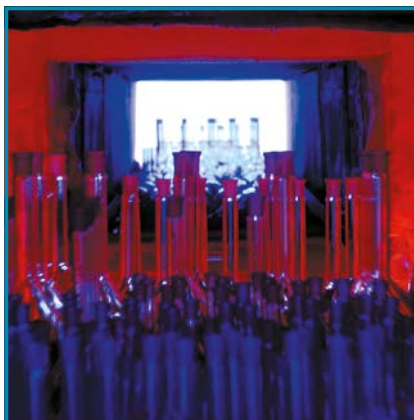

In order to achieve the best results, the furnace has a precise temperature control all-over the thermal heating zone.



Furnace is entirely controlled by electronic panel for guaranteed temperature control at all steps.

packing process

ISOLAB is perfectly aware that the products used in laboratory should be very clean and excellently packed.

All glassware are washed in industrial scale ultrasonic cleaning machines for removing all the dirt and left over particles.

Our staff responsible for the final quality control of the packaging is extremely qualified and well experienced.

High quality packing materials are used to ensure break-free delivery of the products.



Modern industrial scale ultrasonic cleaning machines guarantee perfect removal of all remaining dirt and particles.



The final step of the packing is also the final step of quality control process.

volumetric measurement & liquid handling

calibration



Meniscus is determined automatically at the exact lowest level by a laser beam.

Manual calibration done by an operator carries high risk of mistakes and is not reliable.

All calibration steps are carried out with fully automatic robots.

These robotic machines guarantee the highest level of precision and accuracy.

Although during the calibration process the room temperature environment is kept stable at 20°C any slight change in the room temperature is automatically compensated by the machines.

Meniscus is automatically determined at the exact lowest level by a laser beam.

Application of the meniscus ring line is done by stretching the glass surface for longer persistence with the help of a diamond tool. Later the stretched ring line is stained with either blue or white enamel paint for easy observation of meniscus line.



Filling the blank products with water is done automatically by the calibration machines.

quality control



Steps such as filling the water, finding the meniscus line and controlling the volume are done automatically.

Manual quality control of volumetric products is also very complex and time consuming. Also, manual quality control done by an operator carries high risk of mistakes and is not reliable.

In order to avoid above mentioned risks and to achieve the best reliable results quality control steps are carried out with fully automatic robots which are only used by very few selected manufacturers.

Quality control robot is featured with a high resolution camera and image processing system for the most precise meniscus level control.

Steps such as filling the water, finding the meniscus line and controlling the volume are done automatically.

The balances and the electronic calibrated thermometers are in-line connected to the system for online data transfer.

The operator simply mounts the volumetric glass to the quality control robot and waits for the precision guaranteed outcome.



The operator simply mounts the volumetric glass to the quality control robot and waits for the precision guaranteed outcome.

volumetric measurement & liquid handling conformity

“Conformity” is the compliance of the product with the exact and legal standards defined by German Federal Weights and Measures (Eichordnung) Regulation.

The “conformity testing and certification” is described in detail on **DIN 12600** standard.

According to German law of metrology, only listed accredited manufacturers such as **ISOLAB** with a guaranteed quality assurance are allowed to certify the conformity by printing the conformity logo (**DE-M**) on self manufactured volumetric products.

The manufacturer’s logo should also be printed along with the conformity logo. We are very proud of having this logo printed on our related products as a guarantee of conformity according to **DIN 12600** standard starting from day one.

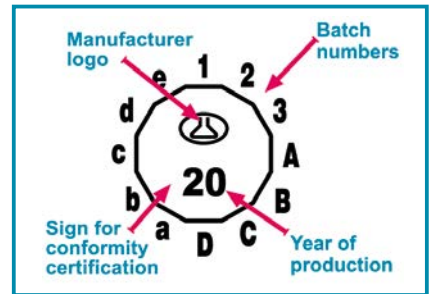

batch certification

“Batch certificate” shows the determined mean value of the controlled standard deviation and tolerance of volumetric products batch to batch.

After the production of each batch, the mandatory minimum quantity is randomly tested and certified according to **DIN 12600** standard.

The “batch certificate” comprises the date of production, mean value, standard deviation, permitted tolerance and other information.

By tracking the batch number user can reach the related batch certificate.

Batch numbers and related certificates can be downloaded from our **ISOLAB** web site. Users can print the “batch certificate” online with the following steps:

- For downloading the certificate please enter www.isolab.de web site, and
- select “downloads/support” from the menu
- select the product code number from “obtain certificates” section
- select the batch number printed on the body
- certificate page comes automatically
- print the page by selecting “printer version” on the left corner.



quality certification

An “individual quality certificate” can also be issued for volumetric products.

“Quality certificate” shows the final and ultime tested factors of the volumetric products.

Such a certificate is always well accepted worldwide since it should be prepared by a worldwide accredited test laboratory.

The selected product is individually tested in the most precise way and controlled as defined by German Federal Weights and Measures (Eichordnung) Regulation and according to **DIN 12600** standard.

Individually prepared and printed quality certificate comprising the date of production, mean value, standard deviation, permitted tolerance and other informations.



volumetric measurement & liquid handling

classification

All volumetric products are always calibrated as **to contain (In)** or **to deliver (Ex)**.

They are classified in three groups; **Class "B"** or **Class "A"** or **"AS"**.

Class "A" and **"AS"** carry exactly the same error and tolerance limits.

The difference is in their "delivery" and "waiting times". "S" means quick (swift) delivery.

The classification as **"A"** or **"B"** indicates the degree of accuracy of related parameters.

Class **"A"** or **"AS"** volumetric products carry highest level of accuracy and specially well accepted by laboratories looking for quality.

The error limits, accuracy and variations are always in accordance with relevant **ISO** or **DIN** standard limits.

delivery time

Delivery time is the time needed to deliver the liquid from the starting level to the final level.

For burettes and pipettes final level is generally the tip of the product.

waiting time

The waiting time starts after complete transfer is finalised.

After the transfer of the liquid usually liquid continues to flow down from the burette or pipette wall.

For accurate volume measurement attention must be paid to the waiting time.

Specially with pipettes the residual drop accumulated at the tip should be considered.

meniscus line

A simple definition of meniscus is the curve on the surface of the liquid.

According to **DIN**, **ISO** and most other standards volume should be read at the lowest liquid level.

The lowest level of the meniscus has to touch the upper edge of the graduation mark.

On the volumetric glassware the form of the meniscus is concave.

For the exact and most precise results, the eye of the observer must be exactly at the same level of meniscus line.

To have a better, faster and more accurate reading and measurement, a black strip should be held at the back side, just below of the graduation mark and meniscus line.

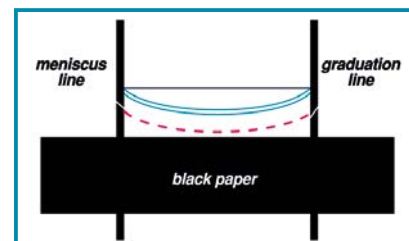

schellbach stripe

The schellbach stripe is a narrow blue band which takes place at the center of a wider white band on the burette tube background.

Mostly printed at the backside of the burette tube for easier observation of meniscus line.

The penetrated light fraction two arrow head points that appear at the meniscus line.

Exact meniscus line is exactly where two arrow heads touch each other.

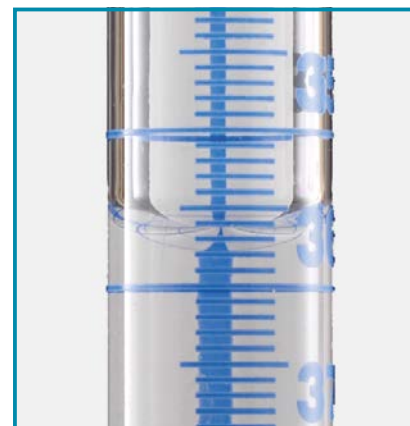
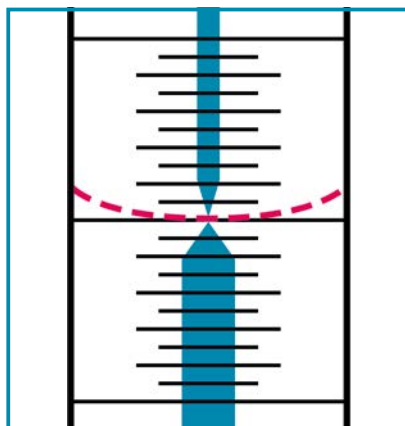

how to use volumetric flasks

- Volumetric flasks are mainly used for preparation of highly accurate solutions.
- First add the exact weight of the product inside the flask. Fill the flask about half the volume and mix the content.
- Then fill again until the level reaches a bit lower than calibration ring mark.
- Adjust the temperature of flask and the content to 20°C.
- Add a little more liquid so that the meniscus will be exactly at the same level of the ring mark.
- Pay attention to read the meniscus at the eye level also not to wet the inner neck wall above the ring mark.



how to use measuring cylinders

- Cylinders are mainly used for the exact measurement of liquid volumes.
- First fill the cylinder with liquid and wait until the residual liquid on the wall will filter down.
- Then read the volume level from the cylinders volume graduation chart.
- Pay attention to read the volume level at the eye level. Do not wet the inner neck wall above the calibration mark.



how to use mixing cylinders

- Mixing cylinders are mainly used for the exact measurement of liquid volumes.
- First fill the cylinder with liquid and wait until the residual liquid on the wall to filter down.
- Then read the volume level from the cylinders volume graduation chart.
- Later add the precise weight of the substance and dissolve it by shaking the cylinder.



how to use burettes

- Fill the burette a bit higher than the "0" level.
- To activate the stopcock, drain the solution but never below the "0" mark.
- Pay attention there will be no air bubbles left in the burette.
- Fill more solution above 10 mm of the "0" mark. Do not wet the burette wall above the liquid level.
- By focusing the meniscus at eye level drain the solution to the exact "0" mark.
- Wipe off the drops at the stopcock tip and slowly start the titration. When color changes stop the titration and wait for the 30 seconds.
- Wipe off the remaining drop since this is also the part of the measured volume.



how to use pipettes

- Fill the liquid max 5 mm above the volume mark. Wipe off the outer surface of the pipette.
- Hold the pipette at eye level and place the tip to the wall of a beaker with a slight angle.
- Discharge the access volume until the meniscus reaches the calibration mark.
- When the level of the liquid reaches to the tip wait according to waiting time.
- When the waiting time is over, wipe the tip gently pulling upwards on the beaker wall and transfer the liquid.
- If there is still any residual liquid left in the tip, never blow out.



how to use density bottles

- Carefully weigh the empty and well dried density bottle.
- Fill the bottle up to 2/3 of the neck level while avoiding air bubbles.
- Adjust the bottle temperature to 20°C in a thermostatic bath. Insert the stopper of the bottle carefully. The capillary of the stopper will discharge the liquid.
- Dry the body of the bottle and the stopper carefully by wiping with a tissue paper. Pay attention not to remove any liquid from the capillary tube.
- The liquid inside of the bottle should exactly be at the same level with the upper end of the capillary tube.
- Final step is weighing the filled density bottle and calculating the density.



volumetric measurement & liquid handling

VOLUMETRIC FLASKS - "glass" - "class A" "conformity certified"



➤ Manufactured from heat resistant borosilicate 3.3 glass according to DIN EN ISO 1042 standard. Calibrated by automatic robots according to DIN/ISO Class "A" standard.

➤ Conformity mark ("DE-M") and batch number printed on the body surface. Batch certificate can be downloaded from website.

➤ Blue and white colored diamond grinded meniscus ring mark offers longer persistence. Inscriptions on the flask bodies are printed with long lasting enamel color.

➤ Flasks are supplied with a leak-proof P.E stopper which ensures perfect closure.

| clear flasks | amber flasks | volume | neck NS size | pack quantity |
|--------------|--------------|----------|--------------|---------------|
| 013.01.005 | 014.01.005 | 5 ml | NS 10/19 | 2 pieces |
| 013.01.010 | 014.01.010 | 10 ml | NS 10/19 | 2 pieces |
| 013.01.020 | 014.01.020 | 20 ml | NS 10/19 | 2 pieces |
| 013.01.025 | 014.01.025 | 25 ml | NS 10/19 | 2 pieces |
| 013.01.026 | 014.01.026 | 25 ml | NS 12/21 | 2 pieces |
| 013.01.050 | 014.01.050 | 50 ml | NS 12/21 | 2 pieces |
| 013.01.051 | 014.01.051 | 50 ml | NS 14/23 | 2 pieces |
| 013.01.100 | 014.01.100 | 100 ml | NS 12/21 | 2 pieces |
| 013.01.101 | 014.01.101 | 100 ml | NS 14/23 | 2 pieces |
| 013.01.150 | | 150 ml | NS 14/23 | 2 pieces |
| 013.01.200 | 014.01.200 | 200 ml | NS 14/23 | 2 pieces |
| 013.01.250 | 014.01.250 | 250 ml | NS 14/23 | 2 pieces |
| 013.01.300 | | 300 ml | NS 14/23 | 2 pieces |
| 013.01.400 | | 400 ml | NS 19/26 | 2 pieces |
| 013.01.500 | 014.01.500 | 500 ml | NS 19/26 | 2 pieces |
| 013.01.901 | 014.01.901 | 1000 ml | NS 24/29 | 2 pieces |
| 013.01.902 | 014.01.902 | 2000 ml | NS 29/32 | 2 pieces |
| 013.01.905 | | 5000 ml | NS 34/35 | 1 piece |
| 013.01.910 | | 10000 ml | NS 45/40 | 1 piece |

150 ml, 300 ml, 400 ml and 10000 ml volumetric flasks are in addition to DIN range.

VOLUMETRIC FLASKS - "glass" - "class A" "conformity certified" - "COATED"



➤ When handling dangerous and/or valuable solutions coated volumetric flasks are highly recommended.

➤ Bodies of these flasks are coated with a special formulated coating which reduces the impacts and also minimize the possible risks in case of breakage. Coating covers the body like a protective glove and holds the broken parts unscattered.

➤ The coating is highly transparent and can resist up to 135°C with maximum period of 30 minutes. Coated flasks should not be exposed directly to open flame.

➤ All other technical specifications are identical with standard body volumetric flasks.

| coated clear flasks | coated amber flasks | volume | neck NS size | pack quantity |
|---------------------|---------------------|---------|--------------|---------------|
| 013.01.005C | 014.01.005C | 5 ml | 10/19 | 2 pieces |
| 013.01.010C | 014.01.010C | 10 ml | 10/19 | 2 pieces |
| 013.01.020C | 014.01.020C | 20 ml | 10/19 | 2 pieces |
| 013.01.025C | 014.01.025C | 25 ml | 10/19 | 2 pieces |
| 013.01.026C | 014.01.026C | 25 ml | 12/21 | 2 pieces |
| 013.01.050C | 014.01.050C | 50 ml | 12/21 | 2 pieces |
| 013.01.051C | 014.01.051C | 50 ml | 14/23 | 2 pieces |
| 013.01.100C | 014.01.100C | 100 ml | 12/21 | 2 pieces |
| 013.01.101C | 014.01.101C | 100 ml | 14/23 | 2 pieces |
| 013.01.150C | | 150 ml | 14/23 | 2 pieces |
| 013.01.200C | 014.01.200C | 200 ml | 14/23 | 2 pieces |
| 013.01.250C | 014.01.250C | 250 ml | 14/23 | 2 pieces |
| 013.01.300C | | 300 ml | 14/23 | 2 pieces |
| 013.01.400C | | 400 ml | 19/26 | 2 pieces |
| 013.01.500C | 014.01.500C | 500 ml | 19/26 | 2 pieces |
| 013.01.901C | 014.01.901C | 1000 ml | 24/29 | 2 pieces |
| 013.01.902C | 014.01.902C | 2000 ml | 29/32 | 2 pieces |

150 ml, 300 ml, 400 ml and 10000 ml volumetric flasks are in addition to DIN range.

VOLUMETRIC FLASKS - "glass" - "class A" - "conformity certified" - "trapezoidal"



- Manufactured from heat resistant, borosilicate glass 3.3 according to DIN EN ISO 1042 standard.
- Trapezoidal body form offers much higher stability and avoids fall over risk.
- Calibrated according to DIN/ISO Class "A" standard. Featured with a ("DE-M") conformity mark according to German Federal Weights and Measures Regulations.
- Individual calibration carried out by automatic robots eliminate possible deviations from nominal values.
- Conformity mark and batch number printed on the body surface. Batch certificate can be downloaded from website.
- Diamond grinded meniscus ring mark offers longer persistence and enables easy observation of meniscus level.
- Inscriptions on the flask bodies are printed with long lasting enamel color.
- All volumetric flasks are supplied with a leak-proof P.E stopper which ensures perfect closure.

Small size flasks with standard body shape can fall over very easily due to their smaller center of gravity.

Compared to other standard volumetric flasks of the same volume, trapezoidal flasks have at least twice base area.

For this reason trapezoidal flasks are much more stable than standard flasks.

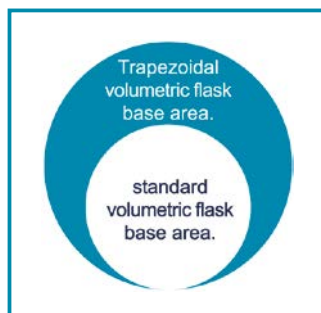

| clear flasks | amber flasks | volume | neck NS size | pack quantity |
|--------------|--------------|--------|--------------|---------------|
| 013.13.001 | 013.15.001 | 1 ml | 07/16 | 2 pieces |
| 013.13.002 | 013.15.002 | 2 ml | 07/16 | 2 pieces |
| 013.13.003 | 013.15.003 | 3 ml | 07/16 | 2 pieces |
| 013.13.004 | 013.15.004 | 4 ml | 07/16 | 2 pieces |
| 013.13.005 | 013.15.005 | 5 ml | 07/16 | 2 pieces |
| 013.13.010 | 013.15.010 | 10 ml | 10/19 | 2 pieces |
| 013.13.020 | 013.15.020 | 20 ml | 10/19 | 2 pieces |
| 013.13.025 | 013.15.025 | 25 ml | 10/19 | 2 pieces |
| 013.13.050 | 013.15.050 | 50 ml | 12/21 | 2 pieces |

VOLUMETRIC FLASKS - "PP" - "class B"



- Manufactured according to DIN EN ISO 1042 standard from clear polypropylene. Resistant to most acids, bases and many commonly used solvents.
- Calibrated according to DIN/ISO Class "B" standard.
- Clear flasks are manufactured from very clear polypropylene resulting high transparency and clear indication of meniscus line.
- Amber flasks are manufactured from special formulated polypropylene preventing UV light penetration into the flask yet still offering high transparency.
- All volumetric flasks are supplied with a leak-proof P.E stopper which ensures perfect closure.
- For consistent accuracy should not be used with liquids over 60°C or kept under direct sunlight for long periods.

| clear flasks | amber flasks | volume | neck NS size | pack quantity |
|--------------|--------------|---------|--------------|---------------|
| 014.03.025 | 014.13.025 | 25 ml | 10/19 | 1 piece |
| 014.03.050 | 014.13.050 | 50 ml | 12/21 | 1 piece |
| 014.03.100 | 014.13.100 | 100 ml | 14/23 | 1 piece |
| 014.03.250 | 014.13.250 | 250 ml | 14/23 | 1 piece |
| 014.03.500 | 014.13.500 | 500 ml | 19/26 | 1 piece |
| 014.03.901 | 014.13.901 | 1000 ml | 24/29 | 1 piece |

volumetric measurement & liquid handling

CYLINDERS - "glass" - "class A" - "conformity certified"

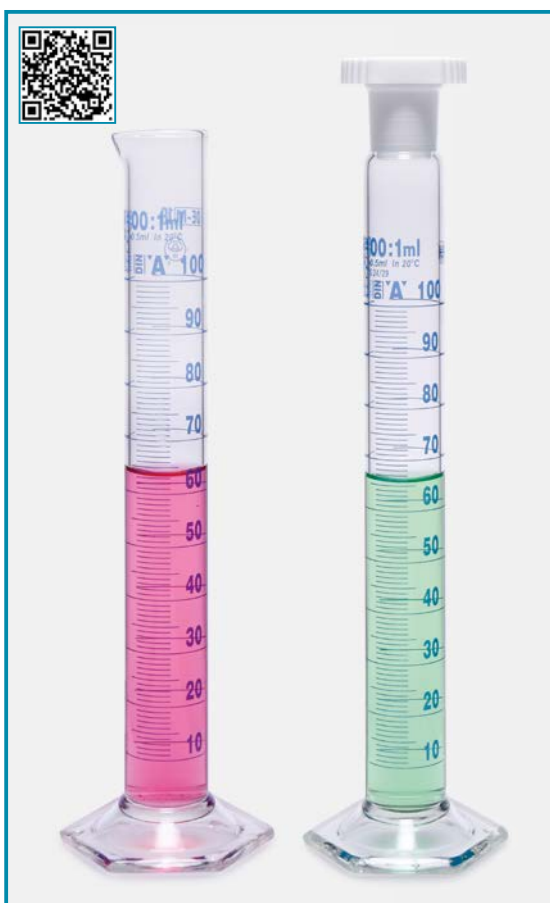

➤ Manufactured from heat resistant borosilicate 3.3 glass according to DIN EN ISO 4788 standard. Calibrated by automatic robots according to DIN/ISO Class "A" standard.

➤ Conformity mark ("DE-M") and batch number printed on the body surface. Batch certificate can be downloaded from website.

➤ Inscriptions on the flask bodies are printed with long lasting enamel color.

➤ Flawless spout design assures pouring without any drips.

➤ Hexagonal base with strengthened knobs ensures increased stability.

➤ Mixing cylinders are supplied with a P.E stopper.

| measuring cylinders | mixing cylinders | volume | pack quantity |
|---------------------|------------------|---------|---------------|
| 015.01.005 | | 5 ml | 2 pieces |
| 015.01.010 | 016.01.010 | 10 ml | 2 pieces |
| 015.01.025 | 016.01.025 | 25 ml | 2 pieces |
| 015.01.050 | 016.01.050 | 50 ml | 2 pieces |
| 015.01.100 | 016.01.100 | 100 ml | 2 pieces |
| 015.01.250 | 016.01.250 | 250 ml | 2 pieces |
| 015.01.500 | 016.01.500 | 500 ml | 2 pieces |
| 015.01.901 | | 1000 ml | 2 pieces |
| | 016.01.901 | 1000 ml | 1 piece |
| 015.01.902 | | 2000 ml | 1 piece |

CYLINDERS "class B" - "P.P base"



➤ Manufactured from heat resistant, durable borosilicate glass according to DIN/ISO Class "B" standard.

➤ These cylinders are supplied with an interchangeable polypropylene base.

➤ Thick and durable polypropylene base reduces the risk of breakage during use and cleaning.

➤ Base perfectly fits the cylinder body and can easily be dismantled.

➤ Flawless spout design assures pouring without any drips.

➤ Inscriptions on the cylinder body are printed with white enamel.

| catalogue number | volume | pack quantity |
|------------------|---------|---------------|
| 016.07.010 | 10 ml | 2 pieces |
| 016.07.025 | 25 ml | 2 pieces |
| 016.07.050 | 50 ml | 2 pieces |
| 016.07.100 | 100 ml | 2 pieces |
| 016.07.250 | 250 ml | 2 pieces |
| 016.07.500 | 500 ml | 2 pieces |
| 016.07.901 | 1000 ml | 2 pieces |

CYLINDERS - "polypropylene" - "class B"



➤ Manufactured according to DIN/ISO Class "B" standard from polypropylene.

➤ Featured with excellent transparency, high chemical and remarkable heat resistance.

➤ Calibrated according to DIN/ISO Class "B" standard.

➤ Flawless spout design assures pouring without drips.

➤ Thick hexagonal base with strengthened knobs ensures increased stability.

➤ For consistent accuracy, should not be used with liquids over 60°C or kept under direct sunlight for long periods.

➤ Inscriptions and nominal values are either in embossed scale or in printed blue scale.

| embossed scale | printed scale | volume | pack quantity |
|----------------|---------------|---------|---------------|
| 016.05.010 | 016.06.010 | 10 ml | 1 piece |
| 016.05.025 | 016.06.025 | 25 ml | 1 piece |
| 016.05.050 | 016.06.050 | 50 ml | 1 piece |
| 016.05.100 | 016.06.100 | 100 ml | 1 piece |
| 016.05.250 | 016.06.250 | 250 ml | 1 piece |
| 016.05.500 | 016.06.500 | 500 ml | 1 piece |
| 016.05.901 | 016.06.901 | 1000 ml | 1 piece |

BURETTES - “straight” - “class AS” - “conformity certified”



► Manufactured from pre-vacuum calibrated borosilicate 3.3 tubing according to ISO 385 standard. Calibrated according to DIN/ISO Class “AS” standard.

► Conformity mark (“DE-M”) and batch number printed on the body surface. Batch certificate can be downloaded from website.

► Supplied with an interchangeable PTFE stopcock with identical keys which does not need “matching the pairs” during cleaning.

► Inscriptions and nominal values are printed with long lasting enamel color.

► Schellbach stripe featured with a narrow blue band which is at the center of the larger white band offers easier and accurate observation of the meniscus line.

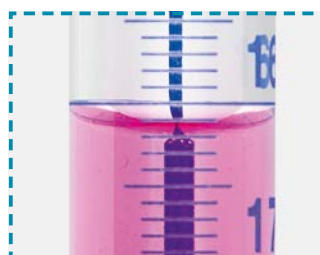

The schellbach stripe has a narrow blue band which is at the center of the larger white band.

The light fraction creates two arrow head points which appear at the meniscus line level.

Meniscus reading point is exactly where these two arrow heads meet each other.

| clear burettes W/O schellbach | clear burettes with schellbach | amber burettes W/O schellbach | volume | pack quantity |
|----------------------------------|-----------------------------------|----------------------------------|--------|---------------|
| 017.02.010 | 017.01.010 | 018.01.010 | 10 ml | 1 piece |
| 017.02.025 | 017.01.025 | 018.01.025 | 25 ml | 1 piece |
| 017.02.050 | 017.01.050 | 018.01.050 | 50 ml | 1 piece |

AUTOMATIC BURETTES - “class AS” - “conformity certified”



► Manufactured from pre-vacuum calibrated borosilicate 3.3 tubing according to ISO 385 standard. Calibrated according to DIN/ISO Class “AS” standard.

► Conformity mark (“DE-M”) and batch number printed on the body surface. Batch certificate can be downloaded from website.

► Featured with an intermediate PTFE stopcock and with a PTFE “needle” valve stopcocks.

► Clear burettes are featured with a schellbach stripe for easier and accurate observation of the meniscus line.

► Inscriptions and nominal values are printed with long lasting enamel color.

► **Automatic burettes are supplied without bottles and bellows. Bottles and bellows should be ordered separately.**



All automatic burettes are featured with an intermediate PTFE stopcock for reliable, fast and accurate measurement.

| clear burettes | amber burettes | volume | pack quantity |
|----------------|----------------|--------|---------------|
| 019.01.010 | 019.05.010 | 10 ml | 1 piece |
| 019.01.025 | 019.05.025 | 25 ml | 1 piece |
| 019.01.050 | 019.05.050 | 50 ml | 1 piece |

volumetric measurement & liquid handling

SCHILLING BURETTES - "class AS"



➤ Manufactured from pre-vacuum calibrated borosilicate 3.3 tubing according to ISO 385 standard. Calibrated according to DIN/ISO Class "AS" standard.

➤ Conformity mark ("DE-M") and batch number printed on the body surface. Batch certificate can be downloaded from website.

➤ Clear schilling burettes are featured with a schellbach stripe.

➤ Supplied with a PTFE "needle" valve stopcock. Inscriptions and nominal values are printed with long lasting enamel color.

| clear burettes | amber burettes | volume | pack quantity |
|----------------|----------------|--------|---------------|
| 020.03.010 | 020.05.010 | 10 ml | 1 piece |
| 020.03.025 | 020.05.025 | 25 ml | 1 piece |
| 020.03.050 | 020.05.050 | 50 ml | 1 piece |

features of Schilling burettes

Schilling burettes are described as an alternative automatic burette specially suitable for field analysis where there is always a risk of breakage.

Schilling burette set consists of a burette tubing similar to glass automatic burette and a polyethylene reservoir bottle with a stabilising stand.

Offers a rapid filling by squeezing the polyethylene reservoir bottle and fast titration through valve stopcock.

ACCESORIES for BURETTES



BOTTLES - "for automatic burettes"

➤ Manufactured from thick glass with 2000 ml volume.

➤ Grinded neck with NS 29/32 socket size perfectly fits to automatic burette's cone.

| clear bottles | amber bottles | pack quantity |
|---------------|---------------|---------------|
| 020.07.010 | 020.07.025 | 1 piece |

BELLOW - "for automatic burettes"

➤ Manufactured from natural rubber. Tube diameter perfectly fits to all connectors.

| catalogue number | bulb type | pack quantity |
|------------------|-----------|---------------|
| 020.08.001 | single | 1 piece |

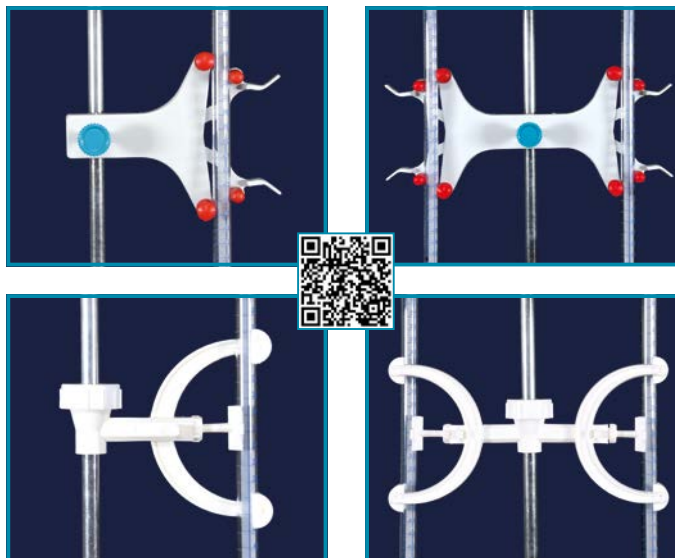

CLAMPS - "for straight burettes"

➤ Manufactured to hold one or two straight burette at a time. They firmly hold the burettes on position and offer an easy observation of volume graduations and meniscus level.

➤ Clamps can be used on rods of diameter 10 mm to 12 mm.

➤ Fixing heads are featured with flexible springs that offers easy insertion and extraction of the burettes.

| catalogue number | clamp type | for holding | pack quantity |
|------------------|---------------|-------------|---------------|
| 018.05.001 | steel | 1 burette | 1 piece |
| 018.05.002 | steel | 2 burettes | 1 piece |
| 018.06.001 | polypropylene | 1 burette | 1 piece |
| 018.06.002 | polypropylene | 2 burettes | 1 piece |

volumetric measurement & liquid handling

PIPETTES - "pasteur" - "polyethylene"

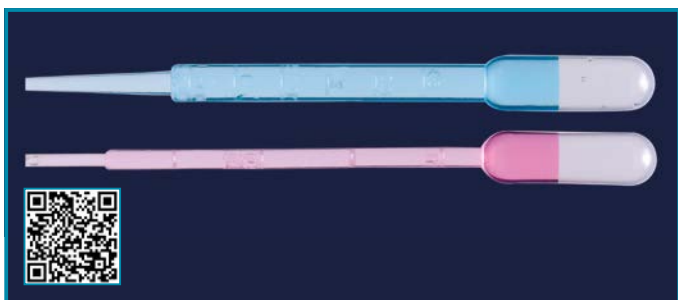

- Manufactured from low density polyethylene. Uniform wall thickness guarantees uniform suction force at all times and offers reproducible drop sizes for each use.
- Ideal for transferring and dispensing liquids safely eliminating the risk of cross contamination.
- Pipette bulb requires very small pressure force. Long and flexible stem can be bent to draw liquids from narrow vessels.
- Featured with embossed volume graduations on the body.

| catalogue number | volume | product descriptions | packing specifications | pack quantity |
|------------------|--------|----------------------|------------------------|---------------|
| 084.02.001 | 3 ml | non-sterilized | in box | 500 pieces |
| 084.22.001 | 3 ml | gamma sterilized | single pack | 100 pieces |
| 084.02.003 | 1 ml | non-sterilized | in box | 500 pieces |
| 084.22.003 | 1 ml | gamma sterilized | single pack | 100 pieces |

PIPETTES - "serological" - "polystyrene"

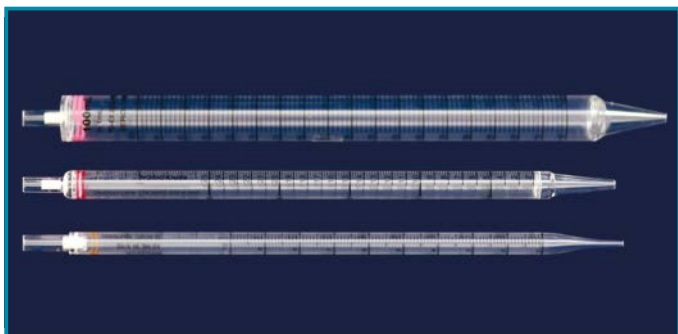

- Manufactured from virgin polystyrene with excellent optical transparency. Sterilized with gamma irradiation. Free of RNase, DNase, DNA and pyrogene.
- Smooth interior prevents cell-hanging and clumping inside the pipette wall. Pipette tip offers constant reproducible flow.
- Optimised mouthpiece perfectly fits to all types of pipette pumps and balls.
- Colour coded ring mark at suction stem allows fast identification and sourcing.
- The sharp, black, highly visible permanent graduations guarantee precise reading.

| catalogue number | pipette volume | color code | box quantity |
|------------------|----------------|------------|--------------|
| 083.13.001 | 1 ml | yellow | 500 pieces |
| 083.13.002 | 2 ml | green | 500 pieces |
| 083.13.005 | 5 ml | blue | 200 pieces |
| 083.13.010 | 10 ml | orange | 200 pieces |
| 083.13.025 | 25 ml | red | 150 pieces |
| 083.13.050 | 50 ml | purple | 100 pieces |
| 083.13.100 | 100 ml | pink | 50 pieces |

DISPENSER BOX - "large"

- Manufactured from crystal clear acrylic with excellent field of vision.
- Ideal for storing and dispensing relatively large scale products such as pasteur pipettes.
- Featured with non-skid silicone feet for stable stand.
- Featured with an easy opening hinged lid. Once opened, the lid stands open for easy dispensing.
- Box offers safe and clean storage of pipettes without been effected from enviromental effects.
- Box external dimensions: 175x250x600 mm.



| catalogue number | pack quantity |
|------------------|---------------|
| 084.05.001 | 1 piece |



PIPETTES - "pasteur" - "glass"



- Manufactured from neutral glass according to ISO 7712 standard.
- Thick walls provide extra strength eliminating the risk of breakage.
- Ideal for transferring and dispensing liquids safely eliminating the risk of cross contamination.
- Featured with a long drawn capillary tip. The design of the suction part allows cotton plugging.

| catalogue number | length | pack quantity | box quantity |
|------------------|--------|---------------|--------------|
| 084.01.001 | 150 mm | 250 pieces | 4 packs |
| 084.01.002 | 230 mm | 250 pieces | 4 packs |

BULB - "for glass pasteur pipettes"



- Manufactured from natural rubber particularly to be used with glass pasteur pipettes.

| catalogue number | pack quantity |
|------------------|---------------|
| 084.03.001 | 100 pieces |

volumetric measurement & liquid handling

PIPETTES - "glass" - "class AS" - "conformity certified"



➤ Manufactured from neutral tubing according to ISO 648 and DIN 12687 (for volumetric pipettes), ISO 835 and DIN 12699 (for graduated pipettes) standards.

➤ Calibrated according to DIN/ISO Class "AS" standard.

➤ Conformity mark ("DE-M") and batch number printed on the body surface. Batch certificate can be downloaded from website.

➤ Carefully formed and bevelled tips ensure proper flow rate. Color coded ring marks allows fast sourcing.

➤ Inscriptions and nominal values are printed with long lasting enamel color.

| graduated pipettes | volumetric pipettes | volume | pack quantity |
|--------------------|---------------------|--------|---------------|
| 021.01.001 | 021.05.001 | 1 ml | 10 pieces |
| 021.01.002 | 021.05.002 | 2 ml | 10 pieces |
| | 021.05.003 | 3 ml | 10 pieces |
| | 021.05.004 | 4 ml | 10 pieces |
| 021.01.005 | 021.05.005 | 5 ml | 10 pieces |
| 021.01.010 | 021.05.010 | 10 ml | 10 pieces |
| | 021.05.011 | 11 ml | 10 pieces |
| | 021.05.015 | 15 ml | 10 pieces |
| 021.01.020 | 021.05.020 | 20 ml | 10 pieces |
| 021.01.025 | 021.05.025 | 25 ml | 10 pieces |
| 021.01.050 | 021.05.050 | 50 ml | 10 pieces |

PIPETTES - "glass" - "class A"

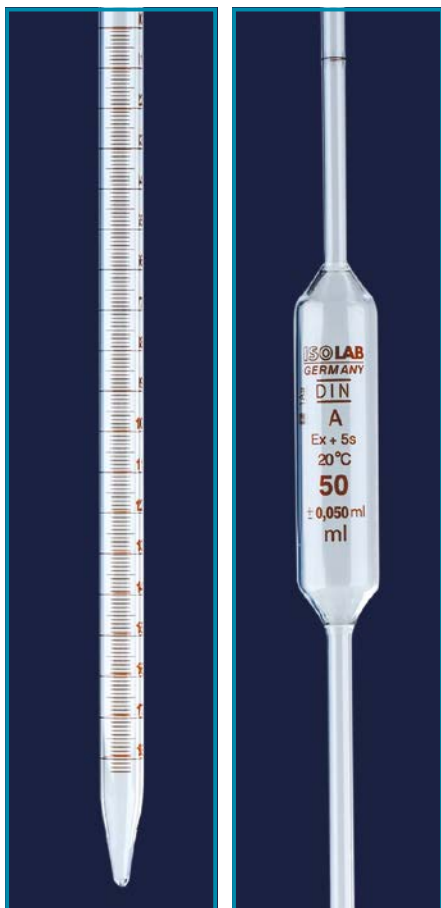

➤ Manufactured from neutral tubing according to ISO 648 and DIN 12687 & ISO 835 and DIN 12699 standards.

➤ Calibrated according to DIN/ISO Class "A" standard.

➤ Carefully formed and bevelled tips ensure proper flow rate. Color coded ring marks allows fast sourcing.

➤ Inscriptions and nominal values are printed with long lasting amber stain.

| graduated pipettes | volumetric pipettes | volume | pack quantity |
|--------------------|---------------------|--------|---------------|
| 021.11.001 | 021.15.001 | 1 ml | 10 pieces |
| 021.11.002 | 021.15.002 | 2 ml | 10 pieces |
| 021.11.005 | 021.15.005 | 5 ml | 10 pieces |
| 021.11.010 | 021.15.010 | 10 ml | 10 pieces |
| | 021.15.015 | 15 ml | 10 pieces |
| 021.11.020 | 021.15.020 | 20 ml | 10 pieces |
| 021.11.025 | 021.15.025 | 25 ml | 10 pieces |
| 021.11.050 | | 50 ml | 10 pieces |

Color coded ring mark at suction stem allows fast identification and sourcing.



STAND - "for pipettes" "carrousel"



➤ Manufactured from polypropylene for holding up to 94 pipettes vertically.

➤ The round carrousel stand can rotate 360° around stand axis enabling easy reach to each pipette.

➤ The grid patterned upper disc which is concentric with the carrier plate keeps the pipettes in vertical and correct position.

➤ The carrier plate consists of four concentric troughs with tapered sides and open bottoms which cradle the pipette tips protectively.

➤ Drained liquid is collected by a stationary rack at the bottom part.

| catalogue number | height x diameter | pack quantity |
|------------------|-------------------|---------------|
| 022.01.001 | 48 x 23 cm | 1 piece |



The grid patterned upper disc which is concentric with the carrier plate keeps the pipettes in vertical and correct position.



The carrier plate consists of four concentric troughs with tapered sides and open bottoms which cradle the pipette tips protectively.

STAND - "linear"



➤ Manufactured from polypropylene for holding up to 12 pipettes horizontally. Easily dismantlable for storage and cleaning purposes.

catalogue
number

022.02.001

pack
quantity

1 piece

TRAY - "for pipettes"



➤ Manufactured from polystyrene for easy organisation of all kind of pipettes.

➤ Crenated design enables holding of large size pipettes in longitudinal direction and short size pipettes in transverse direction.

catalogue
number

022.03.001

dimensions

285 x 215 x 40 mm

pack
quantity

1 piece

TRAY - "for pipettes"



➤ Manufactured from polystyrene for easy organisation of all kind of pipettes.

➤ 1-2-5 and 10 ml pipettes can be stored at 4 different compartments. Can also be used in drawers as well as on bench tops.

catalogue
number

022.03.011

dimensions

300 x 425 x 30 mm

pack
quantity

1 piece

BOX - "for pipettes"



➤ Manufactured from AISI 304 stainless steel with rectangular form. The total box height is not adjustable.

➤ Supplied with a silicone pad that fits to the box base.

➤ Silicone pad acts as a shock absorber and prevents the risk of breakage.

catalogue
number

022.04.001

box base
dimensions

70x70 mm

box
height

210 mm

pack
quantity

1 piece

022.04.002

70x70 mm

430 mm

1 piece

BOX - "for pipettes"



➤ Manufactured from aluminium with cylindrical body form. For to carry pipettes with different height during autoclave sterilisation process. The total box height is adjustable.

➤ Supplied with a silicone pad that fits to the box base. Silicone pad acts as a shock absorber and prevents the risk of breakage.

catalogue
number

022.03.002

box
diameter

60 mm

min. & max.
box height

145-235 mm

pack
quantity

1 piece

022.03.003

60 mm

280-420 mm

1 piece

RACK - "for pipettes"



➤ Manufactured from acrylic for easy organisation of all kinds of pipettes.

➤ 4 shelves guarantee easy and fast reach of all pipettes between 1 ml to 50 ml size with in arm's reach.

➤ Angled design of the pipette shelves prevents the risk of pipettes falling out even the shelf is fully filled.

➤ Featured with magnetic clamps on both sides for arrangement of multiple box assembly.

catalogue
number

022.06.001

dimensions

290x90x400 mm

pack
quantity

1 piece

volumetric measurement & liquid handling

PIPETTE FILLERS - "pi-pump"



- A simple yet practical pipette filler for all pipettes from 2 ml to 25 ml volume range.
- Even very small volumes can be dispensed precisely.
- Pipette stem smoothly fits to the flexible silicone chuck and are firmly hold in position.
- Rotating the existing handwheel on the body upwards draws the liquid precisely to the desired level.
- Rotating the handwheel downwards let the liquid in the pipette discharge partially.
- A slight pressure applied to the fast release lever let the liquid flow-out for complete delivery.



| catalogue number | for pipette volume | pack quantity |
|------------------|--------------------|---------------|
| 011.01.002 | up to 2 ml | 1 piece |
| 011.01.010 | up to 10 ml | 1 piece |
| 011.01.025 | up to 25 ml | 1 piece |



PIPETTE FILLERS - "maxi"



- Advance pipette filler for all pipettes from 1 ml to 100 ml volume range.
- The optimised valve system allows easy draw of liquid without excess pressure.
- Pipette stem smoothly fits to the flexible silicone chuck and are firmly hold in position.
- Very easy to use; before attaching the pipette first squeeze the silicone bulb and release the air inside.
- Attach the pipette. Move the pipetting knob up-ward for filling, down-ward for discharging.
- For blow-out just push the discharge bellow.
- A replaceable hydrophobic membrane filter in the intake cone prevents cross contamination.

| catalogue number | product descriptions |
|------------------|----------------------|
| 011.02.003 | pipette filler |
| 011.02.003.3 | spare filter |



PIPETTE FILLER - "macro"



Standard pipette filler for up to 10 ml pipettes.

- Bulb manufactured from natural rubber. Most common pipette filler for all types of pipettes up to 100 ml volume. Standard model can be used up to 10 ml pipettes. Universal model can be used up to 100 ml pipettes.

- Evacuation can be easily done by pressing the related automatic valves. Offers an easy single hand use. Pressing the valve the liquid is drawn-up to the desired level, dispensed partially or blown-out.

| catalogue number | model | for pipettes | pack quantity |
|------------------|-----------|--------------|---------------|
| 011.02.001 | standard | up to 10 ml | 1 piece |
| 011.02.002 | universal | up to 100 ml | 1 piece |



Universal pipette filler for up to 100 ml pipettes.

PIPETTE FILLER



- Simple and easily controllable pipette filler for all pipettes up to 15 ml volume.

- Very easy to use; First squeeze the bulb and release the air inside. Then attach the pipette. Release the bulb pressure and fill the pipette. For discharge squeeze the bulb again.

| catalogue number | pack quantity |
|------------------|---------------|
| 011.04.001 | 1 piece |



| catalogue number | for pipette volume | pack quantity |
|------------------|--------------------|---------------|
| 011.04.003 | max 3 ml | 10 pieces |
| 011.04.005 | max 5 ml | 10 pieces |
| 011.04.010 | max 10 ml | 10 pieces |

PIPETTE FILLER

- Manufactured from silicone. Ideal for simple pipetting applications.

- Offered with three different volume capacity.



volumetric measurement & liquid handling

PIPETTE PUMP - "electrical"



- For all kinds of pipettes from 0,1 ml to 100 ml volume range.
- Ergonomic, light weight and well balanced body offers full comfort and fatigue-free pipetting.
- Powerful pump can fill a 25 ml pipette under 4 seconds.
- Pump speed can be adjusted to 8 different levels. LCD display visually shows the selected speed. Also offers gravimetric drain.
- Changeable lithium-ion batteries provide 8 hours continuous use. LCD display shows remaining battery power.
- The high-tech charger prevents over charging and provides long life cycle. 2-3 hours is required for full charge.
- Silicone adapter in the intake cone holds firmly the pipettes in position. Replaceable hydrophobic 0,45µm PTFE filter prevents cross contamination.
- Supplied with a wall mounting and a dual-position stand.

| catalogue number | for pipettes | speed range | pack quantity |
|------------------|--------------|-------------|---------------|
| 010.01.005 | 0,1 - 100 ml | adjustable | 1 piece |



Replaceable hydrophobic 0,45 µm PTFE filter secures cross contamination.
Catalogue No: 610.01.005

Silicone adapter in the intake cone holds firmly the pipettes in position.

PIPETTE PUMP - "electrical"



- For all kinds of pipettes from 0,1 ml to 100 ml volume range.
- Ergonomic, light weight and well balanced body offers full comfort and fatigue-free pipetting.
- Powerful pump can fill a 25 ml pipette under 4 seconds.
- Pump speed can be selected as high and low speed modes. Also offers gravimetric drain.
- Changeable lithium-ion batteries provide 8 hours continuous use. Featured with a visual red bulb low battery indicator.
- The high-tech charger prevents over charging and provides long life cycle. 2-3 hours is required for full charge.
- Silicone adapter in the intake cone holds firmly the pipettes in position. Replaceable hydrophobic 0,45µm PTFE filter prevents cross contamination.
- Supplied with a wall mounting and a single-position stand.

| catalogue number | for pipettes | speed range | pack quantity |
|------------------|--------------|-------------|---------------|
| 010.01.006 | 0,1 - 100 ml | adjustable | 1 piece |



Replaceable hydrophobic 0,45 µm PTFE filter secures cross contamination.
Catalogue No: 610.01.006

Silicone adapter in the intake cone holds firmly the pipettes in position.

volumetric measurement & liquid handling



BURETTE - "digital" - "motor driven"

- The most advanced digital burette featured with motor controlled piston movement. Conforms ISO 8655 standard. Guarantees reliable measuring results with bubble-free dispensing and consistent delivery with self calibration function.
- Offers an operating volume range from 0,01 ml to 99,99 ml with 0,01 ml resolution with a maximum piston lift of 10 ml.
- Back drawn valve for recirculating the liquid into the bottle without any loss of reagent.
- User friendly TFT control touchscreen guides the user for a quick and accurate titration. System also avoids manual disturbance and human errors. 16 stage dispensing speeds allow the user to achieve titration end point precisely.
- Dispensing can be performed by a touch at the screen and stops immediately when the touch is removed.
- BSG, PTFE, FEP are used in the liquid path provides excellent chemical resistance to most common laboratory reagents. Outer surface is made of ABS. Visible glass barrel allows inspection of the liquid before and during dispensing.
- Magnetic stirrer has a motor free design and featured with 5 programmable speeds.
- Precision valve ensures easy priming and minimum waste with no back leakage into the reservoir bottle.
- Discharge tube can be turned to any desired position since the body can rotate 360° round the axis.
- Featured with a built in ergonomic and compact ultra flat magnetic stirrer for easier and faster titration and also more stable and consistent results.



| catalogue number | volume range (ml) | volume accuracy | pack quantity |
|------------------|-------------------|-----------------|---------------|
| 007.01.002 | 0,01-99,99 | 0,01 ml | 1 piece |

DISPENSER - "repetitive"



- Ergonomically designed and light weight dispenser for fast and simple serial dispensing of liquids.
- Perfect tool for applications where repetitive dispensing is a must and where time is valuable.
- Very easy to use; first fill the dispenser tip with the liquid similar to a syringe. Then press the pipette button for each dispensing step.
- All functions can be controlled only by three control mechanisms.
- Offers 5 volume settings and 7 different dispenser tip sizes results with 35 alternative different volumes.
- Depending on the size & volume of the tip used - it is possible to dispense between 0,5 ml to 50 ml liquid in multi-interval.
- Works on the positive displacement principle which enables dispensing of even high density and high vapour liquids.
- Dispensing volume can be selected from the volume scale on the body.

| catalogue number | pack quantity |
|------------------|---------------|
| 008.06.001 | 1 piece |

DISPENSER TIPS - "repetitive"

- Dispenser tips are manufactured from clear polypropylene.
- 7 different tip sizes offer 35 alternative different volumes.
- Graduation on the side of the tips enables visual confirmation of the volume.



Adapter for 25 & 50 ml tip should be ordered separately
Cat. No: 008.06.002

| catalogue number | dispenser tip volume | pack quantity |
|------------------|------------------------|---------------|
| 008.06.005 | 0.50 ml | 10 pieces |
| 008.06.012 | 1.25 ml | 10 pieces |
| 008.06.025 | 2.50 ml | 10 pieces |
| 008.06.050 | 5.00 ml | 10 pieces |
| 008.06.125 | 12.50 ml | 10 pieces |
| 008.06.250 | 25.00 ml | 10 pieces |
| 008.06.500 | 50.00 ml | 10 pieces |
| 008.06.002 | adapter for 25 & 50 ml | |

DISPENSERS - "advanced model"



➤ Guarantees reliable results with bubble-free dispensing of liquids. Fully autoclavable body provides high precision with consistent delivery.

➤ Available in 6 volume ranges covering a range from 2,5 ml to 100 ml.

➤ Individually calibrated according to ISO 8655 standard and supplied with a calibration certificate.

➤ All wetted parts are PTFE, FEP, PFA and borosilicate glass ensuring highest degree of chemical resistance.

➤ Springless PTFE valve manifold ensures excellent chemical compatibility and leak-proof functioning.

➤ This also ensures wiper like movement of the piston making it suitable for all kinds of crystalline liquids.

➤ PTFE piston and viton "O" ring guarantees fatigue-free, smooth, effortless piston movement and high accuracy.

➤ Dosing cylinder is protected against breakage by a polypropylene sleeve.

➤ Large volume scale printed on both sides of the body guarantees fast, easy and precise volume readings.

➤ Adapter rotates freely 360° on the bottle neck and redirects the discharge to the desired position.

➤ Easy volume setting with 180° rotating volume adjustment knob.

➤ Discharge tube cap prevents drying and accidental dropping.

➤ Supplied with 4 adaptors (28, 38, 40 & 45 mm diameter) to fit almost all available reservoir bottle necks.

➤ The telescopic extractable intake tube can be adjusted simply by pulling according to different bottle heights.

➤ Specially designed calibration tool is provided with each dispenser for convenient and fast user recalibration.

➤ **Alternative 2 dispensers:** • without recirculation valve • with recirculation valve



Volume scale printed on both sides of the body guarantees precise volume readings.



Built in recirculation valve prevents reagent loss during purging,



Adapter rotates freely 360° on the bottle neck and redirects the discharge to the desired position.



Fast, easy and reliable volume setting with 180° rotating volume adjustment knob.



Discharge tube cap reduces contact with the air and prevents drying. Also prevents accidental dropping.



Supplied in a perfectly designed modern and sturdy box featured for compartments for every piece.

| volume | without re-circulation valve | with re-circulation valve | pack quantity |
|---------------|------------------------------|---------------------------|---------------|
| 0.3 - 2.5 ml | 008.12.002 | 008.15.002 | 1 piece |
| 0.5 - 5 ml | 008.12.005 | 008.15.005 | 1 piece |
| 1.0 - 10 ml | 008.12.010 | 008.15.010 | 1 piece |
| 2.5 - 30 ml | 008.12.030 | 008.15.030 | 1 piece |
| 5.0 - 60 ml | 008.12.060 | 008.15.060 | 1 piece |
| 10.0 - 100 ml | 008.12.100 | 008.15.100 | 1 piece |

volumetric measurement & liquid handling

MICROPIPETTES - "adjustable volume"

- 9 models covers volume range from 0,25 µl to 10 ml and combines all the requirements of a modern pipette.
- Each pipette is individually calibrated according to ISO 8655 and certified. Supplied with an individual calibration certificate.
- Ultralight and well balanced body offers greatest comfort for extended pipetting periods.
- Contoured and ergonomic body shape fits perfectly to all hand sizes.
- Guarantees fast and easy volume setting with single hand. Volume display is always fully visible.
- Thumb friendly soft spring pipetting system reduce plunger pressure.
- Ergonomic finger hook offers comfortable handling and to take the weight for a more relaxed grip.
- Tip ejector with large pad reduces thumb pressure workload and guarantees easy tip ejection. (except 011.05.910)

| non-autoclavable pipettes | autoclavable pipettes | volume range | pack quantity |
|---------------------------|-----------------------|-----------------|---------------|
| 011.06.002 | 011.05.002 | 0.1 - 2.5 µl | 1 piece |
| 011.06.010 | 011.05.010 | 0.5 - 10 µl | 1 piece |
| 011.06.020 | 011.05.020 | 2 - 20 µl | 1 piece |
| 011.06.050 | 011.05.050 | 5 - 50 µl | 1 piece |
| 011.06.100 | 011.05.100 | 10 - 100 µl | 1 piece |
| 011.06.200 | 011.05.200 | 20 - 200 µl | 1 piece |
| 011.06.901 | 011.05.901 | 100 - 1000 µl | 1 piece |
| 011.06.905 | 011.05.905 | 1000 - 5000 µl | 1 piece |
| 011.06.910 | 011.05.910 | 1000 - 10000 µl | 1 piece |



PIPETTING RESERVOIRS - "non-sterile & sterile" - "disposable"



Bottoms with a sloping "V" form and tapered in a narrow through.



- Manufactured from polystyrene featured with thick walls and crush-resistant corners as single, disposable use.
- Offers a clean, practical and economical alternative to all other re-usable pipetting reservoirs.
- Featured with a visible volume marking on the side wall.
- Large pour-back spouts at the corners guarantee safe pouring back the remaining liquid in to the original container.
- Easily stackable due to the tapered body form for reducing storage space. Liquid reservoirs do not stick to each other even stacked.
- Bottoms with a sloping "V" form and tapered in a narrow through guarantee maximum liquid recovery.

| catalogue number | volume | product specifications | pack quantity |
|------------------|--------|------------------------|---------------|
| 006.03.030 | 30 ml | non-sterile | 100 pieces |
| 006.13.030 | 30 ml | gamma sterile | 10 pieces |
| 006.03.055 | 55 ml | non-sterile | 100 pieces |
| 006.13.055 | 55 ml | gamma sterile | 10 pieces |
| 006.03.110 | 110 ml | non-sterile | 100 pieces |
| 006.13.110 | 110 ml | gamma sterile | 10 pieces |

MICROPIPETTES - "adjustable volume" - "autoclavable" - "for research"



- ▶ One pipette with exchangeable fix-volume controllers solves all your problems. Offer as single channel and 8 channel models.
- ▶ 9 models cover volume range from 0,2 µl to 10 ml and fulfill all the requirements of a modern pipette.
- ▶ Autoclavable, ultralight and well balanced body offers greatest comfort for extended pipetting periods.
- ▶ PP/PVDF/ anodised aluminium and stainless steel body construction guarantees the highest level of accuracy and precision.
- ▶ Dual "O" ring technology guarantees best tip fit. Outer "O" rings makes tip loading easy.
- ▶ Fast and easy volume setting with single hand. Volume setting requires 50% fewer turns compared to some brands.
- ▶ Volume lock prevents accidental volume changes during operation. Volume display is always fully visible.
- ▶ Thumb friendly soft spring pipetting system reduces plunger pressure by up to 50% and guarantees the whole procedure more comfortable.
- ▶ Ergonomic finger hook offers comfortable handling and to take the weight for a more relaxed grip.
- ▶ Color-coded tip ejector reduces thumb workload by 70 % compared with other brands.
- ▶ Large pad of tip ejector guarantees easy tip ejection.
- ▶ Each pipette is individually calibrated and certified. Serial number is printed on each pipette.

| volume range | single channel | inaccuracy | imprecision % | 8 channel | inaccuracy | imprecision % | color code | pack quantity |
|---------------|----------------|------------|---------------|------------|------------|---------------|------------|---------------|
| 0.2 - 2.0 µl | 011.20.002 | 12.00/2.00 | 6.00/1.00 | | | | | 1 piece |
| 0.5 - 10 µl | 011.20.010 | 2.50/1.00 | 1.80/0.50 | 011.21.010 | 5.00/2.00 | 3.60/1.00 | | 1 piece |
| 2 - 20 µl | 011.20.020 | 5.00/1.00 | 1.50/0.30 | | | | | 1 piece |
| 5 - 50 µl | 011.20.050 | 2.00/1.00 | 1.20/0.30 | 011.21.050 | 3.20/1.40 | 1.60/0.60 | | 1 piece |
| 10 - 100 µl | 011.20.100 | 2.50/0.70 | 1.00/0.20 | | | | | 1 piece |
| 20 - 200 µl | 011.20.200 | 2.50/0.60 | 0.70/0.20 | 011.21.200 | 1.80/1.20 | 0.80/0.40 | | 1 piece |
| 30 - 300 µl | | 1.66/1.40 | 0.60/0.30 | 011.21.300 | 1.66/1.40 | 0.60/0.30 | | 1 piece |
| 100 - 1000 µl | 011.20.901 | 2.00/0.80 | 0.60/0.20 | | | | | 1 piece |
| 1 - 5 ml | 011.20.905 | 1.20/0.60 | 0.30/0.15 | | | | | 1 piece |
| 1 - 10 ml | 011.20.910 | 3.00/0.60 | 0.60/0.15 | | | | | 1 piece |

volume lock feature



Select the desired volume and lock the indicator.

- ▶ Volume lock feature allows selecting the desired volume and locking the indicator to achieve a more reliable pipetting experience.
- ▶ Locking feature prevents accidental volume changes during pipetting procedures.
- ▶ Simply slide the button to the upper position to lock or lower to release.

dual "O" ring

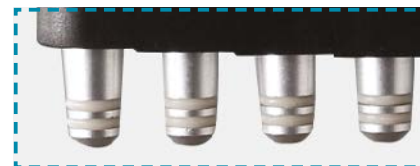

Dual "O" ring technology: guarantees best tip fit.

- ▶ Outer "O" rings make tip loading easier. The first "O" ring creates a smooth seal while the second "O" ring creates a positive stop to ensure that the tips are airtight, sealed, and can be ejected with the smallest amount of force.

volumetric measurement & liquid handling

PIPETTE TIPS - "precision" - "for research"



- Manufactured from FDA approved polypropylene with consistent quality.
- Manufactured in fully automatic, human touch-free, clean room facilities as DNase, RNase, Pyrogen free. Certified on lot basis.
- Low retention is achieved by a special resin which offers minimum retention and maximum accuracy allowing complete retrieval of precious samples.
- Maximum sample recovery eliminates sample hold-up, providing the most accurate sample delivery.
- Exclusive molding technology reduces the sample loss, saves costly reagents and maximises accuracy and precision.
- Filtered tips prevents cross contamination from sample to sample by creating a physical barrier in the tip to inhibit and block aerosols.
- Optimised shape fits to all common pipettes to give perfect seal between the pipette tip and the pipette shaft.
- Different lengths within the same volume range for different applications.



Alternative packing options:

Puncture resistant bags:

- Base with a wide gusset enables self-standing and allows single-handed access.
- Heat sealed above the zip-lock closure, product integrity and cleanliness is assured right down to the last tip.

Durable boxes:

- Easy to open-close hinged lid boxes with internal rib structure provide an extremely strong platform.
- Features recessed wells to ensure perfect tip allignment.



| catalogue number | product descriptions | packing specifications |
|------------------|--|------------------------|
| T-B-010 | pipette tip - ISOLAB - clear - 10 µl - bag | 1000 pieces / bag |
| T-R-010 | pipette tip - ISOLAB - clear - 10 µl - box | 96 pieces / box |
| T-R-S-010 | pipette tip - ISOLAB - clear - 10 µl - box - sterile | 96 pieces / box |
| TF-010 | pipette tip - filter - ISOLAB - clear - low retention - 10 µl - bag | 1000 pieces / bag |
| TF-R-S-010 | pipette tip - filter - ISOLAB - clear - low retention - 10 µl - box - sterile | 96 pieces / box |
| T-B-011 | pipette tip - ISOLAB - clear - long - 10 µl - bag | 1000 pieces / bag |
| T-R-011 | pipette tip - ISOLAB - clear - long - 10 µl - box | 96 pieces / box |
| T-R-S-011 | pipette tip - ISOLAB - clear - long - 10 µl - box - sterile | 96 pieces / box |
| TF-011 | pipette tip - filter - ISOLAB - clear - low retention - long - 10 µl - bag | 1000 pieces / bag |
| TF-R-S-011 | pipette tip - filter - ISOLAB - clear - low retention - long - 10 µl - box - sterile | 96 pieces / box |
| TF-R-S-021 | pipette tip - filter - ISOLAB - clear - low retention - long - 20 µl - box - sterile | 96 pieces / box |
| TF-50 | pipette tip - ISOLAB - with filter - clear - 50 µl - bag | 1000 pieces / bag |
| TF-R-S-50 | pipette tip - ISOLAB - clear - low retention - 50 µl - box - sterile | 96 pieces / box |
| TF-100 | pipette tip - filter - ISOLAB - clear - low retention - 100 µl - bag | 1000 pieces / bag |
| TF-R-S-100 | pipette tip - filter - ISOLAB - clear - low retention - 100 µl - box - sterile | 96 pieces / box |
| T-B-200 | pipette tip - ISOLAB - clear - 200 µl - bag | 1000 pieces / bag |
| T-R-200 | pipette tip - ISOLAB - clear - 200 µl - box | 96 pieces / box |
| T-R-S-200 | pipette tip - ISOLAB - clear - 200 µl - box - sterile | 96 pieces / box |
| TF-200 | pipette tip - filter - ISOLAB - clear - low retention - 200 µl - bag | 1000 pieces / bag |
| TF-R-S-200 | pipette tip - filter - ISOLAB - clear - low retention - 200 µl - box - sterile | 96 pieces / box |
| T-B-300 | pipette tip - ISOLAB - clear - 300 µl - bag | 1000 pieces / bag |
| T-R-300 | pipette tip - ISOLAB - clear - 300 µl - box | 96 pieces / box |
| T-R-S-300 | pipette tip - ISOLAB - clear - 300 µl - box - sterile | 96 pieces / box |
| TF-300 | pipette tip - filter - ISOLAB - clear - low retention - 300 µl - bag | 1000 pieces / bag |
| TF-R-S-300 | pipette tip - filter - ISOLAB - clear - low retention - 300 µl - box - sterile | 96 pieces / box |
| T-B-1000 | pipette tip - ISOLAB - clear - 1000 µl - bag | 1000 pieces / bag |
| T-R-1000 | pipette tip - ISOLAB - clear - 1000 µl - box | 96 pieces / box |
| T-R-S-1000 | pipette tip - ISOLAB - clear - 1000 µl - box - sterile | 96 pieces / box |
| TF-1000 | pipette tip - filter - ISOLAB - clear - low retention - 1000 µl - bag | 1000 pieces / bag |
| TF-R-S-1000 | pipette tip - filter - ISOLAB - clear - low retention - 1000 µl - box - sterile | 96 pieces / box |
| T-B-1250 | pipette tip - ISOLAB - clear - 1250 µl - bag | 500 pieces / bag |
| T-R-1250 | pipette tip - ISOLAB - clear - 1250 µl - box | 96 pieces / box |
| T-R-S-1250 | pipette tip - ISOLAB - clear - 1250 µl - box - sterile | 96 pieces / box |
| TF-1250 | pipette tip - filter - ISOLAB - clear - low retention - 1250 µl - bag | 500 pieces / bag |
| TF-R-S-1250 | pipette tip - filter - ISOLAB - clear - low retention - 1250 µl - box - sterile | 96 pieces / box |
| TB-5000A | pipette tip - ISOLAB - clear - 5000 µl - bag | 100 pieces / bag |
| TB-5000A-S | pipette tip - ISOLAB - clear - 5000 µl - bag - sterile | 100 pieces / bag |
| TB-5000B | pipette tip - ISOLAB - clear - 5000 µl - bag | 100 pieces / bag |
| TB-5000B-S | pipette tip - ISOLAB - clear - 5000 µl - bag - sterile | 100 pieces / bag |
| TB-10000A | pipette tip - ISOLAB - clear - 10000 µl - bag | 100 pieces / bag |
| TB-10000A-S | pipette tip - ISOLAB - clear - 10000 µl - bag - sterile | 100 pieces / bag |
| TB-10000B | pipette tip - ISOLAB - clear - 10000 µl - bag | 100 pieces / bag |
| TB-10000B-S | pipette tip - ISOLAB - clear - 10000 µl - bag - sterile | 100 pieces / bag |

maximum sample recovery



Isolab tip after dispensing 100 µl sample.

ISOLAB tips are made from low liquid retention resins that provides superior sample recovery while increasing accuracy and reproducibility.

- Allows for complete retrieval of precious samples.
- Saves costly reagents by reducing sample loss.
- Optimizes accuracy of the pipettor and also transfer of blood plasma.
- Avoids denaturation of nucleic acids and protein samples.



Other brand standart tip after dispensing 100 µl sample.

filter tips

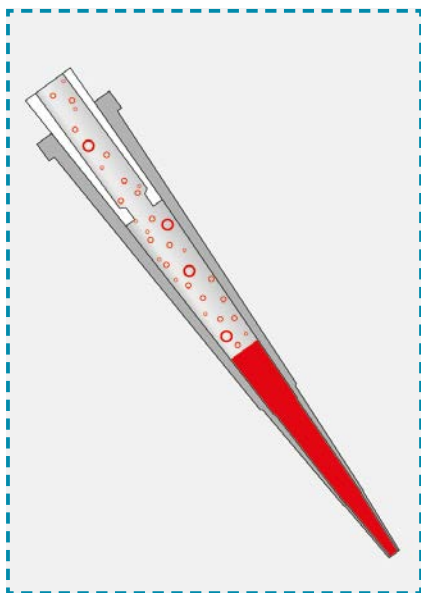

ISOLAB filter tips offer the ultimate in protection against contamination.

- Filter barriers block aerosols by coalescing radioactive, chemical or biological contaminants before they can come in contact of pipettor shaft.
- Their usage is mostly essential in critical applications such as PCR, DNA sequencing and other techniques that involve the use of vaporous, biohazardous or corrosive material.
- Tip filters also act as a safety barrier against accidental over-pipetting of liquids without risk of sample lock-up.

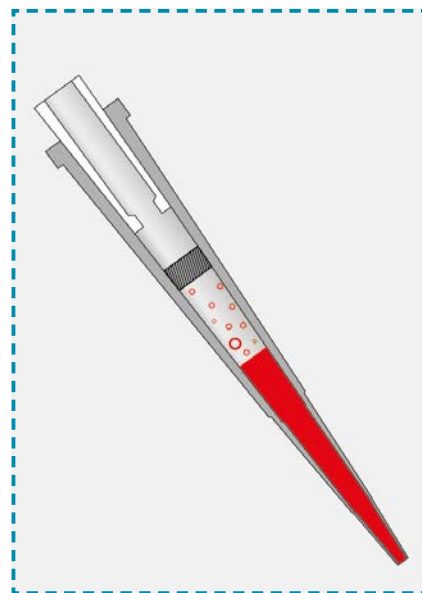

PIPETTE TIPS - "economical"

- Manufactured from high quality pure polypropylene which is highly resistant to chemicals and thermal effects.

- Produced to match wide variety of pipettors for secure sealing and easy tip ejecting.

- Uniformity in size and shape allows perfect fitting with almost all micropipettes.

- Flashfree and uniform delivery orifice for consistent accuracy and reproducible sample delivery.

- Thin wall and small surface area at the tip minimize the possible tip retaining samples droplets.

| catalogue number | capacity | color | pack quantity |
|------------------|----------|--------|---------------|
| 005.01.001 | 10 µl | clear | 1000 pcs |
| 005.01.002 | 200 µl | yellow | 1000 pcs |
| 005.01.003 | 1000 µl | blue | 500 pcs |
| 005.01.004 | 5 ml | clear | 250 pcs |
| 005.01.005 | 10 ml | clear | 100 pcs |
| 005.01.015 | 10 ml | clear | 100 pcs |

- Please kindly order 005.01.005 pipette tips for 011.05.910

- Please kindly order 005.01.015 pipette tips for 011.06.910 and 011.20.910

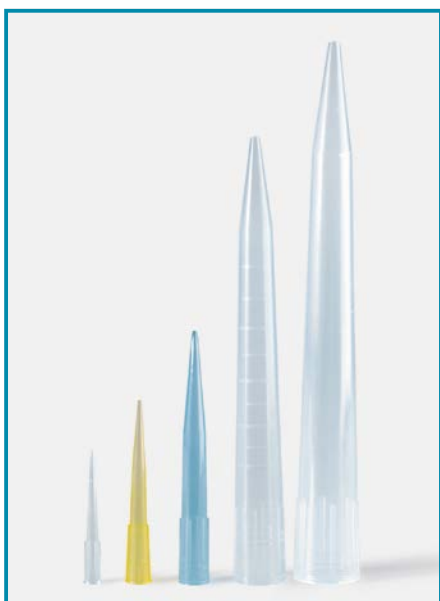

volumetric measurement & liquid handling



STAND - "micropipette" "carrousel"

- Manufactured from polypropylene for using with most common micropipette brands.
- This space saving, robust stand can hold up to 6 pipettes comfortably.
- The round carrousel stand can rotate 360° around the axis enabling easy reach of any pipette.

| catalogue number | base diameter | total height | pack quantity |
|------------------|---------------|--------------|---------------|
| 006.11.005 | 160 mm | 320 mm | 1 piece |



STAND - "micropipette" - "with bin"

- Manufactured from acrylic with a bin. The top support can hold 4 single channel pipettes.
- Generous opening of the bin provides easy and safe access to partitions.
- Cover is featured with easy opening sliding lid. Once opened, the lid stays open and enables easy filling and dispensing.
- Bin guarantees safe and clean storage of box pipette tips without been effected from dust, moisture and other environmental effects.
- Featured with non-skid silicone feet for safe and stable stand on the laboratory desks.

| catalogue number | dimensions | pack quantity |
|------------------|--------------------|---------------|
| 006.12.004 | 130 x 260 x 220 mm | 1 piece |
| 006.12.006 | 150 x 380 x 220 mm | 1 piece |

| catalogue number | dimensions | pack quantity |
|------------------|--------------------|---------------|
| 006.05.001 | 200 x 178 x 173 mm | 1 piece |



The unique adjustable pipette holding design guarantees the use with different height pipettes.

Linear micropipette stand can also hold multi-channel pipettes.



STAND - "micropipette" "linear"

- Manufactured from polypropylene for using with most common micropipette brands.
- Offers practical and easy direct access to micropipettes.
- This space saving, robust stand can hold up to 6 pipettes comfortably.



STAND - "micropipette" "adjustable"

- Manufactured from acrylic with ergonomic angled body form with adjustable pipette holding option.
- Can be used with most pipette brands.
- Depending on the stand size enables easy holding and handling of 4 or 6 single channel pipettes.



ISOLAB

Laborgeräte GmbH



*lab consumables
& labware*



lab consumables & labware



BEAKERS - "glass"

➤ Manufactured from heat resistant, borosilicate glass 3.3 according to ISO 3819 and DIN 12331 standards.

➤ Thick wall, heavy base and reinforced rim prevent breakage.

| catalogue number | volume | pack quantity |
|------------------|----------|---------------|
| 025.01.005 | 5 ml | 10 pieces |
| 025.01.010 | 10 ml | 10 pieces |
| 025.01.025 | 25 ml | 10 pieces |
| 025.01.050 | 50 ml | 10 pieces |
| 025.01.100 | 100 ml | 10 pieces |
| 025.01.150 | 150 ml | 10 pieces |
| 025.01.250 | 250 ml | 10 pieces |
| 025.01.400 | 400 ml | 10 pieces |
| 025.01.600 | 600 ml | 10 pieces |
| 025.01.800 | 800 ml | 10 pieces |
| 025.01.901 | 1000 ml | 10 pieces |
| 025.01.902 | 2000 ml | 6 pieces |
| 025.01.905 | 5000 ml | 1 piece |
| 025.01.910 | 10000 ml | 1 piece |

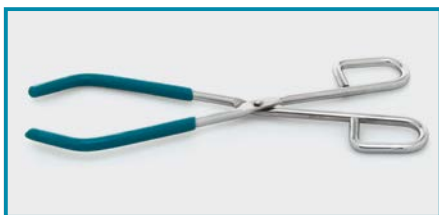
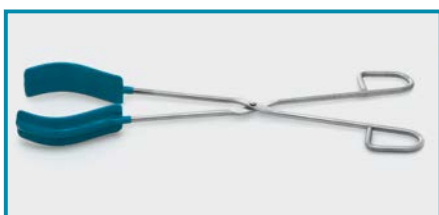

Various beaker tongs can be selected from catalogue page no 52.



BEAKERS - "polypropylene" - "embossed & printed scale"

➤ Manufactured from ultra clear polypropylene according to ISO 7056 standard with thick walls. Resistant to most acids, bases and many commonly used solvents. Functional large spout minimize possible spills during liquid transfer.

| embossed scale | volume | pack quantity |
|----------------|---------|---------------|
| 026.01.025 | 25 ml | 1 piece |
| 026.01.050 | 50 ml | 1 piece |
| 026.01.100 | 100 ml | 1 piece |
| 026.01.250 | 250 ml | 1 piece |
| 026.01.500 | 500 ml | 1 piece |
| 026.01.901 | 1000 ml | 1 piece |
| 026.01.902 | 2000 ml | 1 piece |



BEAKERS - "stainless steel"

➤ Manufactured from AISI 304 grade stainless steel.

➤ Highly polished smooth interior enables much easier cleaning.

| catalogue number | volume | pack quantity |
|------------------|---------|---------------|
| 025.04.100 | 100 ml | 1 piece |
| 025.04.250 | 250 ml | 1 piece |
| 025.04.500 | 500 ml | 1 piece |
| 025.04.901 | 1000 ml | 1 piece |



| blue printed scale | volume | pack quantity |
|--------------------|---------|---------------|
| 026.03.025 | 25 ml | 1 piece |
| 026.03.050 | 50 ml | 1 piece |
| 026.03.100 | 100 ml | 1 piece |
| 026.03.250 | 250 ml | 1 piece |
| 026.03.500 | 500 ml | 1 piece |
| 026.03.901 | 1000 ml | 1 piece |
| 026.03.902 | 2000 ml | 1 piece |



BEAKERS - "PTFE"

➤ Manufactured from chemically inert PTFE with excellent chemical resistance, and high temperature resistance between -200°C to +260°C.

| catalogue number | volume | pack quantity |
|------------------|---------|---------------|
| 025.03.050 | 50 ml | 1 piece |
| 025.03.100 | 100 ml | 1 piece |
| 025.03.250 | 250 ml | 1 piece |
| 025.03.500 | 500 ml | 1 piece |
| 025.03.901 | 1000 ml | 1 piece |



BEAKERS WITH HANDLE - "P.P" - "embossed & printed scale"

- Manufactured from ultra clear polypropylene according to ISO 7056 standard with thick walls. Resistant to most acids, bases and many commonly used solvents.
- Functional large spout minimize possible spills during liquid transfer.
- Easily stackable due to the tapered body form for reducing storage space.

| embossed scale | volume | pack quantity |
|----------------|---------|---------------|
| 026.02.250 | 250 ml | 1 piece |
| 026.02.500 | 500 ml | 1 piece |
| 026.02.901 | 1000 ml | 1 piece |
| 026.02.902 | 2000 ml | 1 piece |
| 026.02.903 | 3000 ml | 1 piece |

| blue printed | volume | pack quantity |
|--------------|---------|---------------|
| 026.04.250 | 250 ml | 1 piece |
| 026.04.500 | 500 ml | 1 piece |
| 026.04.901 | 1000 ml | 1 piece |
| 026.04.902 | 2000 ml | 1 piece |
| 026.04.903 | 3000 ml | 1 piece |

BEAKERS WITH HANDLE "stainless steel"

- Manufactured from AISI 304 grade stainless steel.
- Highly polished smooth interior enables much easier cleaning.
- Moulded graduations on the side wall offer easy volume identification.

| catalogue number | volume | pack quantity |
|------------------|---------|---------------|
| 025.05.500 | 500 ml | 1 piece |
| 025.05.901 | 1000 ml | 1 piece |
| 025.05.902 | 2000 ml | 1 piece |

FLASKS - "glass" "round & flat bottom"

- Manufactured from heat resistant, borosilicate glass 3.3 according to ISO 1773 standard.
- Thick wall, heavy base and reinforced rim prevent breakage.



| round bottom | volume | pack quantity |
|--------------|----------|---------------|
| 029.02.050 | 50 ml | 10 pieces |
| 029.02.100 | 100 ml | 10 pieces |
| 029.02.250 | 250 ml | 10 pieces |
| 029.02.500 | 500 ml | 10 pieces |
| 029.02.901 | 1000 ml | 10 pieces |
| 029.02.902 | 2000 ml | 6 pieces |
| 029.02.904 | 4000 ml | 1 piece |
| 029.02.906 | 6000 ml | 1 piece |
| 029.02.910 | 10000 ml | 1 piece |

| flat bottom | volume | pack quantity |
|-------------|----------|---------------|
| 029.01.050 | 50 ml | 10 pieces |
| 029.01.100 | 100 ml | 10 pieces |
| 029.01.250 | 250 ml | 10 pieces |
| 029.01.500 | 500 ml | 10 pieces |
| 029.01.901 | 1000 ml | 10 pieces |
| 029.01.902 | 2000 ml | 6 pieces |
| 029.01.904 | 4000 ml | 1 piece |
| 029.01.906 | 6000 ml | 1 piece |
| 029.01.910 | 10000 ml | 1 piece |

Various flask stands can be selected from catalogue page no 99.

lab consumables & labware

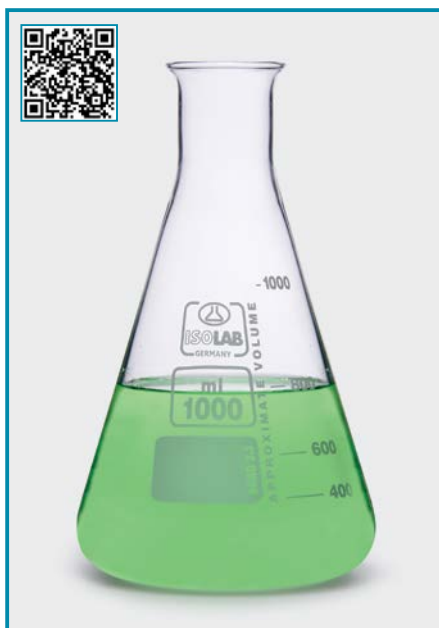

ERLENMEYERS - "clear" "glass" - "narrow neck"

➤ Manufactured from heat resistant, borosilicate glass 3.3 according to ISO 1773 standard.

➤ Thick wall, heavy base and reinforced rim prevent breakage.

| catalogue number | volume | pack quantity |
|------------------|---------|---------------|
| 027.01.025 | 25 ml | 10 pieces |
| 027.01.050 | 50 ml | 10 pieces |
| 027.01.100 | 100 ml | 10 pieces |
| 027.01.250 | 250 ml | 10 pieces |
| 027.01.300 | 300 ml | 10 pieces |
| 027.01.500 | 500 ml | 10 pieces |
| 027.01.901 | 1000 ml | 10 pieces |
| 027.01.902 | 2000 ml | 6 pieces |
| 027.01.903 | 3000 ml | 1 piece |
| 027.01.905 | 5000 ml | 1 piece |



ERLENMEYERS - "clear" "glass" - "screw cap"

➤ Manufactured from heat resistant, borosilicate glass 3.3 with a leak-proof screw cap.

➤ Thick wall, heavy base and reinforced rim prevent breakage.

➤ Supplied with a polypropylene screw cap with large ridges for increased grip.

➤ Unique internal flanged design of the caps guarantees leak-proof closure.

| catalogue number | neck size | volume | pack quantity |
|------------------|-----------|---------|---------------|
| 027.03.100 | GL 32 | 100 ml | 1 piece |
| 027.03.250 | GL 32 | 250 ml | 1 piece |
| 027.03.500 | GL 32 | 500 ml | 1 piece |
| 027.03.901 | GL 32 | 1000 ml | 1 piece |



ERLENMEYERS - "clear" "polypropylene" - "screw cap"

➤ Manufactured from clear polypropylene.

➤ Thick wall, heavy base and reinforced rim prevent breakage.

➤ Supplied with a polypropylene screw cap with large ridges for increased grip.

➤ Unique internal flanged design of the caps guarantees leak-proof closure.

| catalogue number | neck size | volume | pack quantity |
|------------------|-----------|---------|---------------|
| 028.03.050 | GL 40 | 50 ml | 1 piece |
| 028.03.100 | GL 40 | 100 ml | 1 piece |
| 028.03.250 | GL 52 | 250 ml | 1 piece |
| 028.03.500 | GL 52 | 500 ml | 1 piece |
| 028.03.901 | GL 52 | 1000 ml | 1 piece |

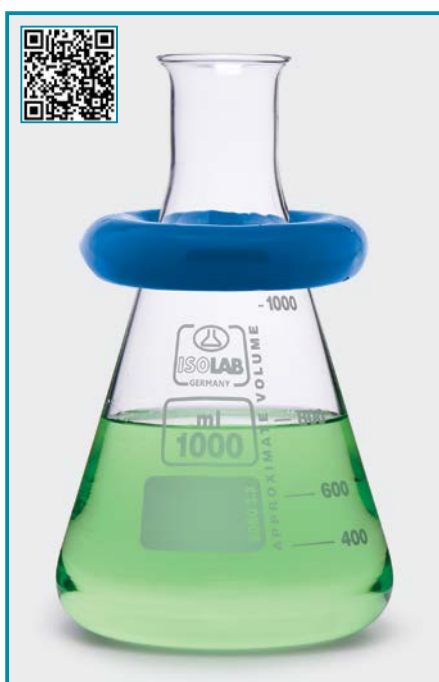

STABILISING RINGS - "for erlenmeyers & flasks"

➤ Manufactured from heavy alloy with different internal diameters for perfect fit to the necks of various volume erlenmeyers and flasks.

➤ Can fit neatly around the neck of erlenmeyers and other flasks preventing falling over or floating risks in water baths.

➤ Soft vinyl coated ring surface prevents scratching the glass surface during use.



| catalogue number | internal diameter | external diameter | recommended for | pack quantity |
|------------------|-------------------|-------------------|-------------------|---------------|
| 027.11.048 | 48 mm | 85 mm | 100 ml - 500 ml | 1 piece |
| 027.11.056 | 56 mm | 100 mm | 250 ml - 1000 ml | 1 piece |
| 027.11.061 | 61 mm | 115 mm | 500 ml - 2000 ml | 1 piece |
| 027.11.074 | 74 mm | 129 mm | 1000 ml - 4000 ml | 1 piece |



Featured with 4 integrated baffles for efficient mixing. Baffles create a turbulent flow, enlarge gas exchange surface and increase oxygen intake.

ERLENMEYERS - "baffled - straight neck - for cell culture"

➤ Manufactured from borosilicate glass. Featured with 4 integrated baffles for efficient mixing.

➤ Baffles create a turbulent flow, enlarge gas exchange surface and increase oxygen intake. Baffles also allow stable swirling for effective mixing.

➤ Widely used in microbiology for the preparation of microbial suspension culture. Ideal for cultivating *S. Cerevisiae* and aerobic bacteria cultures.

➤ Thick wall, heavy base and reinforced rim prevent breakage. Supplied without caps.

| catalogue number | volume | neck diameter | largest outer dia. | height | pack quantity |
|------------------|---------|---------------|--------------------|--------|---------------|
| 027.06.100 | 100 ml | 38 mm | 64 mm | 112 mm | 1 piece |
| 027.06.250 | 250 ml | 38 mm | 85 mm | 145 mm | 1 piece |
| 027.06.500 | 500 ml | 38 mm | 105 mm | 182 mm | 1 piece |
| 027.06.901 | 1000 ml | 38 mm | 129 mm | 230 mm | 1 piece |
| 027.06.902 | 2000 ml | 38 mm | 165 mm | 275 mm | 1 piece |



CAP - "aluminium"

➤ Manufactured from aluminium for perfect fit to the necks of glass baffled erlenmeyers with straight neck.

➤ Chrome nickel springs grip to the neck of the outer wall of the vessel.

| catalogue number | pack quantity |
|------------------|---------------|
| 027.06.101 | 1 piece |



STOPPER - "cellulose"

➤ Manufactured from additive free autoclavable. Air permeable, actively breathing best quality cellulose.

➤ Provide excellent sealing for microbiological samples in tissue culture tubes, flasks etc.

| catalogue number | pack quantity |
|------------------|---------------|
| 051.24.009 | 10 pieces |

ERLENMEYERS - "for cell culture" - "sterile"

➤ Manufactured from PETG. Caps are manufactured from HDPE.

➤ Widely used for the preparation of suspension cultures both in cell culture and microbiological applications such as *E.coli*, plant callus, etc.



| volume | catalogue number | cap type | catalogue number | cap type | pack quantity |
|---------|------------------|----------|------------------|----------|---------------|
| 250 ml | 027.17.250 | plug | 027.18.250 | filter | 12 pieces |
| 500 ml | 027.17.500 | plug | 027.18.500 | filter | 12 pieces |
| 1000 ml | 027.17.901 | plug | 027.18.901 | filter | 6 pieces |

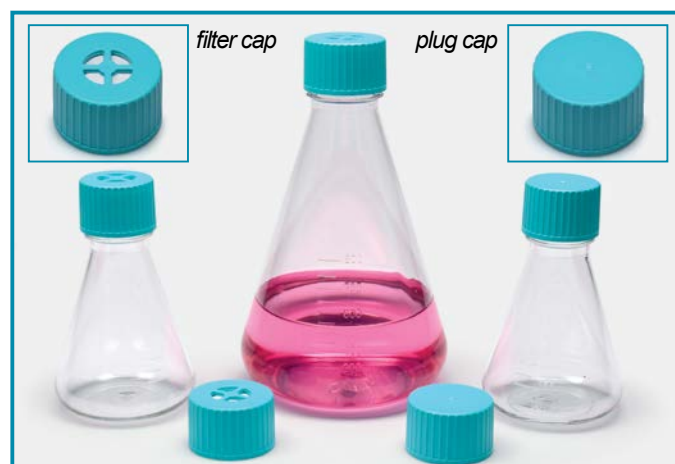

BOTTLES - "ISO" - "borosilicate glass"

- Manufactured from heat resistant, durable borosilicate glass with thick walls and crush-resistant corners.
- These impact resistant, excellently thermal stable bottles are autoclavable at 121°C. Caps should not be closed during autoclaving.
- Angled neck form allows unrestricted liquid flow out without leaving any residue at the bottle neck.
- A large GL 45 bottle neck provides easy filling and pouring. Unique design pouring ring prevents drops and spillage.
- Caps are made from polypropylene with large ridges with increased grip. Cap inner design ensures hermetical and leak-proof closure.
- Volume graduations on wall side offers better liquid level viewing. Graduations and inscriptions are printed with white enamel.

Color coded caps enable easy and practical identification of bottle content. Color coded caps can be selected from page no 69.



| volume | neck NS size | clear bottles | pack quantity | amber bottles | pack quantity |
|----------|--------------|---------------|---------------|---------------|---------------|
| 100 ml | GL 45 | 061.01.100 | 10 pieces | 061.02.100 | 1 piece |
| 250 ml | GL 45 | 061.01.250 | 10 pieces | 061.02.250 | 1 piece |
| 500 ml | GL 45 | 061.01.500 | 10 pieces | 061.02.500 | 1 piece |
| 1000 ml | GL 45 | 061.01.901 | 10 pieces | 061.02.901 | 1 piece |
| 2000 ml | GL 45 | 061.01.902 | 4 pieces | 061.02.902 | 1 piece |
| 3000 ml | GL 45 | 061.01.903 | 1 piece | 061.02.903 | 1 piece |
| 5000 ml | GL 45 | 061.01.905 | 1 piece | 061.02.905 | 1 piece |
| 10000 ml | GL 45 | 061.01.910 | 1 piece | 061.02.910 | 1 piece |
| 20000 ml | GL 45 | 061.01.920 | 1 piece | 061.02.920 | 1 piece |



COATED BOTTLES - "glass" - "clear & amber"

- When handling dangerous and/or valuable solutions coated bottles are highly recommended.
- They are featured with identical technical specifications of clear and amber bottles with codes 061.01.xxx and 061.02.xxx.
- Bodies of these bottles are coated with a special formulated coating which reduces the impacts. Coating covers the body like a protective glove and holds the broken parts unscattered.
- The coating also holds the broken glass together so that the leakage will be minimum. In most of the cases this coating keeps the solutions still inside the flask body without leakage.
- The coating is highly transparent and can resist up to 135°C with maximum period of 30 minutes. These bottles can be cleaned at maximum 95°C and can be repeatedly autoclaved at 121°C.
- Coated bottles should not be exposed directly to open flame.

| volume | neck NS size | coated clear bottles | coated amber bottles | pack quantity |
|---------|--------------|----------------------|----------------------|---------------|
| 100 ml | GL 45 | 061.01.100C | 061.02.100C | 1 piece |
| 250 ml | GL 45 | 061.01.250C | 061.02.250C | 1 piece |
| 500 ml | GL 45 | 061.01.500C | 061.02.500C | 1 piece |
| 1000 ml | GL 45 | 061.01.901C | 061.02.901C | 1 piece |
| 2000 ml | GL 45 | 061.01.902C | 061.02.902C | 1 piece |



BOTTLES - "ISO" - "polypropylene"



Sterile bottles are manufactured at aseptically sterile production halls and then sent to gamma sterilisation.

Such informations as lot number, production and expiry dates etc. are indicated on the packing.

- Manufactured from special formulated polypropylene with thick walls and crush-resistant corners.
- Featured with high transparency and best chemical heat tolerance.
- These impact resistant, excellently thermal stable bottles are autoclavable at 121°C. Caps should not be closed during autoclaving.
- Angled neck form allows unrestricted liquid flow out without leaving any residue at the bottle neck.
- A large GL 45 bottle neck provides easy filling and pouring. Unique design of the neck with moulded pouring ring prevents drops and spillage.
- Cap with large ridges with increased grip featured with self lock and internal security ring. Cap inner design ensures hermetical and leak-proof closure.
- Embossed volume graduations on wall side offers better liquid level viewing and reproducible filling of the bottle without the need of a measuring cylinder.

➤ **Alternative 2 bottles:** ➤ **Clear bottles**
➤ **Amber bottles**

- Clear bottles are manufactured from very clear polypropylene resulting with high transparency and for better view of the bottle content.
- Amber bottles are manufactured from special formulated polypropylene preventing UV light penetration into the flask yet still offering high transparency.

➤ **Alternative 2 products:** ➤ **Non-sterile bottles**
➤ **Gamma sterile bottles**

- Sterile bottles are manufactured at aseptically sterile production halls and then send to gamma sterilisation. Such informations as lot number, production and expiry dates etc are indicated on the packing.

| clear bottles non-sterile | clear bottles gamma sterile | amber bottles non-sterile | amber bottles gamma sterile | neck size | volume | pack quantity |
|---------------------------|-----------------------------|---------------------------|-----------------------------|-----------|---------|---------------|
| 061.15.100 | 061.16.100 | 061.17.100 | 061.18.100 | GL 45 | 100 ml | 100 pieces |
| 061.15.250 | 061.16.250 | 061.17.250 | 061.18.250 | GL 45 | 250 ml | 100 pieces |
| 061.15.500 | 061.16.500 | 061.17.500 | 061.18.500 | GL 45 | 500 ml | 100 pieces |
| 061.15.901 | 061.16.901 | 061.17.901 | 061.18.901 | GL 45 | 1000 ml | 50 pieces |
| 061.15.902 | 061.16.902 | 061.17.902 | 061.18.902 | GL 45 | 2000 ml | 50 pieces |



Unique design of the cap with intended top plate guarantees tight and leakproof closure.



Integral security ring of the cap ensures safe and untouched protection of the bottle content.



Caps are made from robust and thick polyethylene with large ridges for increased grip.



Unique neck design with moulded pouring ring prevents drops and liquid splash.

lab consumables & labware

BOTTLES - "square" - "wide neck" - "polyethylene"

- Manufactured from polyethylene with thick walls and crush-resistant corners.
 - A large bottle neck provides easy filling and pouring.
 - Cap offers increased grip. Featured with an insert plug for hermetical and leak-proof closure.
 - Bottle neck and the cap carry holes for enabling the insertion of the security seal wire.
 - The space between the cap and the insert plug can be used for securing confidential notes.
 - Embossed volume graduations on wall side offers better liquid level viewing and reproducible filling of the bottle without the need of a measuring cylinder.
- **Alternative 2 bottles:**
- **Clear bottles**
 - **Amber bottles**
- Clear bottles are manufactured from very clear P.E resulting with high transparency and for better view of the bottle content.
 - Amber bottles are manufactured from special formulated P.E preventing UV light penetration into the flask yet still offering high transparency.



| clear bottles | amber bottles | bottle volume | dimensions | pack quantity |
|---------------|---------------|---------------|----------------|---------------|
| 061.07.050 | 061.08.050 | 50 ml | 37x39x73 mm | 50 pieces |
| 061.07.100 | 061.08.100 | 100 ml | 50x45x90 mm | 50 pieces |
| 061.07.250 | 061.08.250 | 250 ml | 64x57x112 mm | 50 pieces |
| 061.07.500 | 061.08.500 | 500 ml | 85x72x140 mm | 50 pieces |
| 061.07.901 | 061.08.901 | 1000 ml | 104x82x173 mm | 50 pieces |
| 061.07.902 | 061.08.902 | 2000 ml | 134x100x210 mm | 50 pieces |



The space between cap and insert plug can be used for private and confidential notes.

SECURITY SEALS

- Security seal is used to ensure the safety locking and durability of the product inside the bottles.
- 4 different colors are used to identify among the seals with identification numbers printed on the seal plate.



061.09.0B1 061.09.0R1 061.09.0Y1 061.09.0G1

| catalogue number | color | pack quantity |
|------------------|--------|---------------|
| 061.09.0B1 | blue | 10 pieces |
| 061.09.0R1 | red | 10 pieces |
| 061.09.0Y1 | yellow | 10 pieces |
| 061.09.0G1 | green | 10 pieces |



Insert the seal wire through the holes of both the cap and bottle itself. Then insert the wire into the hole of the seal as shown.

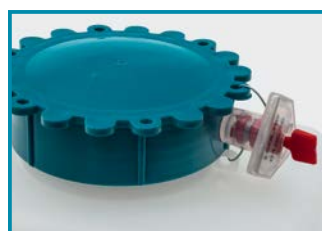

Last step is to wind the seal key clockwise until the seal wire gets tight enough to provide optimum security lock.

SECURITY SEAL CUTTER

- Security seal cutter is a perfect tool to cut security seal wires easily.

| catalogue number | pack quantity |
|------------------|---------------|
| 061.20.001 | 1 piece |



BOTTLES - "glass" - "wide neck"

- Manufactured from neutral glass with thick walls and crush-resistant corners.
 - Ideal for safe storage and transportation of liquids and powders.
 - Thick wall, heavy base and reinforced rim prevent breakage during washing and transportation.
 - A large bottle neck provides easy filling and pouring. Unique design of the neck prevents drops and spillage.
 - Caps are made from polypropylene with large ridges for fast closure.
 - Cap inner design with LDPE washer ensures hermetical and leak-proof closure.
- **Alternative 2 bottles:**
- **Clear bottles**
 - **Amber bottles**
- Amber bottles prevents UV light penetration into the bottle and protects sensitive samples.



| clear bottles | amber bottles | volume | neck size | bottle diameter | bottle height | pack quantity |
|---------------|---------------|---------|-----------|-----------------|---------------|---------------|
| 061.10.050 | 061.11.050 | 50 ml | 32 mm | 44 mm | 75 mm | 10 pieces |
| 061.10.100 | 061.11.100 | 100 ml | 40 mm | 50 mm | 93 mm | 10 pieces |
| 061.10.250 | 061.11.250 | 250 ml | 55 mm | 70 mm | 113 mm | 10 pieces |
| 061.10.500 | 061.11.500 | 500 ml | 55 mm | 85 mm | 154 mm | 10 pieces |
| 061.10.901 | 061.11.901 | 1000 ml | 68 mm | 104 mm | 181 mm | 10 pieces |

BOTTLES - "aluminium"

- These odour-natural, impervious to light and rust proof bottles are manufactured from aluminium.
- Ideal for storing and transporting of samples and products which have to be stored totally unaltered.
- Bottle neck provides easy filling and pouring. Unique design of the neck prevents drops and spillage.
- Caps with large ridges with increased grip featured with self lock and internal security ring. Cap inner design ensures hermetical and leak-proof closure.
- These bottles are supplied with an insert plug for hermetical and leak-proof closure.
- Round neck form allows unrestricted liquid flow out without leaving any residue at the bottle neck.
- 6 lt, 12 lt and 31 lt aluminium bottles are featured with a sturdy handle for easy carrying.



Bottles are supplied with an insert plug for hermetical leak-proof closure.



| catalogue number | volume | neck size | bottle diameter | bottle height | pack quantity |
|------------------|---------|-----------|-----------------|---------------|---------------|
| 061.14.025 | 25 ml | GL 18 | 40 mm | 80 mm | 10 pieces |
| 061.14.060 | 60 ml | GL 32 | 45 mm | 90 mm | 10 pieces |
| 061.14.120 | 120 ml | GL 32 | 50 mm | 120 mm | 10 pieces |
| 061.14.300 | 300 ml | GL 32 | 55 mm | 165 mm | 10 pieces |
| 061.14.600 | 600 ml | GL 45 | 75 mm | 195 mm | 10 pieces |
| 061.14.901 | 1200 ml | GL 45 | 90 mm | 225 mm | 10 pieces |
| 061.14.906 | 6 L | GL 60 | 173 mm | 335 mm | 1 piece |
| 061.14.912 | 12 L | GL 50 | 215 mm | 430 mm | 1 piece |
| 061.14.931 | 31 L | GL 50 | 310 mm | 500 mm | 1 piece |



| catalogue number | volume | recommended for | neck size | bottle Ø x H | pack quantity |
|------------------|---------|-----------------|-----------|--------------|---------------|
| 061.47.050 | 50 ml | for powders | GL 40 | 50x78 mm | 10 pieces |
| 061.47.125 | 125 ml | for powders | GL 40 | 55x109 mm | 10 pieces |
| 061.47.250 | 250 ml | for powders | GL 60 | 69x130 mm | 10 pieces |
| 061.47.500 | 500 ml | for powders | GL 60 | 82x172 mm | 10 pieces |
| 061.47.901 | 1000 ml | for powders | GL 60 | 100x210 mm | 10 pieces |
| 061.46.901 | 1000 ml | for liquids | GL 45 | 100x222 mm | 10 pieces |
| 061.46.902 | 2500 ml | for liquids | GL 45 | 140x300 mm | 10 pieces |



| item no | catalogue number | volume | neck size | neck O.D | W x L x H (mm) | pack quantity |
|---------|------------------|---------|-----------|----------|-----------------|---------------|
| 1 | 061.41.500 | 500 ml | GL 45 | 45 mm | 90 x 90 x 163 | 50 pieces |
| 2 | 061.41.901 | 1000 ml | GL 45 | 45 mm | 95 x 95 x 207 | 50 pieces |
| 3 | 061.41.902 | 2500 ml | GL 45 | 45 mm | 127 x 127 x 310 | 25 pieces |
| 4 | 061.41.905 | 5000 ml | GL 45 | 45 mm | 145 x 145 x 386 | 25 pieces |



Unique design of the cap with inverted top plate guarantees tight and leakproof closure.



Integral security ring of the cap ensures safe and untouched protection of the bottle content.

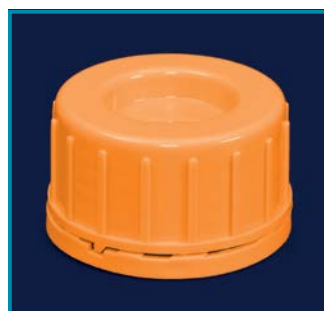

Caps are made from robust and thick polyethylene with large ridges for increased grip.



GL 45 caps for liquid bottles are featured with a PTFE protective insert for additional safety.

BOTTLES - "glass"

- Manufactured from neutral glass with thick walls and amber color.
- Amber bottles prevents UV light penetration into the bottle and protects sensitive samples.
- Specially recommended for safe storage and transportation of liquids, powders and pastes.
- Thick wall, heavy base and reinforced rim prevent breakage during washing and transportation.
- Bottle necks provide easy filling and pouring of samples.
- Caps are made from P.E with large ridges for fast closure.
- Cap inner design with inverted top plate ensures hermetical and leak-proof closure. GL 45 caps for liquid bottles are featured with a PTFE protective insert.
- Featured with self lock and internal security ring for safe protection of the bottle content.

BOTTLES - "HDPE" - "for liquids"

- Manufactured from best quality high density polyethylene with thick walls and crush-resistant corners to minimise deformation by vacuum.
- They offer remarkable resistance and durability with highest safety. Wide base avoids the risk of tip over.
- Bottles 2,5 lt and higher volume are featured with a full hand handle for easier and safe product pouring.
- The large bottle neck provides easy filling and pouring. Unique design of the neck with moulded pouring ring prevents drops and spillage.
- Cap inner design with inverted top plate ensures hermetical and leak-proof closure. **GL 45 caps for liquid bottles are featured with a PTFE protective insert.**
- Featured with self lock and internal security ring for safe protection of the bottle content.

BOTTLES - "HDPE"

➤ Manufactured from best quality high density polyethylene with thick walls and crush-resistant corners to minimise deformation by vacuum.

➤ They offer remarkable resistance and durability with highest safety. Wide base avoids the risk of tip over of the bottle and maximises safety.

➤ These bottles guarantee optimum solutions for safe handling, storage and transport of solid chemicals.

➤ The large bottle neck provides easy filling and pouring. Unique design of the neck with moulded pouring ring prevents spillage.

➤ Cap inner design with inverted top plate ensures hermetical and leak-proof closure.

➤ Featured with self lock and internal security ring for safe protection of the bottle content.



| item no | catalogue number | volume | neck size | neck O.D | W x L x H (mm) | pack quantity |
|---------|------------------|---------|-----------|----------|-----------------|---------------|
| 1 | 061.42.125 | 125 ml | GL 45 | 45 mm | 60 x 60 x 96 | 50 pieces |
| 2 | 061.42.250 | 250 ml | GL 63 | 63 mm | 86 x 86 x 145 | 50 pieces |
| 3 | 061.42.500 | 500 ml | GL 63 | 63 mm | 90 x 90 x 175 | 50 pieces |
| 4 | 061.42.901 | 1000 ml | GL 63 | 63 mm | 96 x 96 x 207 | 50 pieces |
| 5 | 061.42.911 | 1500 ml | GL 63 | 63 mm | 116 x 116 x 246 | 50 pieces |
| 6 | 061.42.902 | 2500 ml | GL 80 | 80 mm | 127 x 127 x 272 | 25 pieces |



Unique design of the cap with inverted top plate guarantees tight and leakproof closure.



Integral security ring of the cap ensures safe and untouched protection of the bottle content.

BOTTLES - "PET" - "sterile"

➤ Manufactured from special formulated PET with thick walls and crush-resistant corners. Specially recommended for safe storage and transportation of cell culture media.

➤ These bottles are manufactured at aseptically sterile production halls and then send to gamma sterilisation. They can be used for all analysis where a sterile sample is required.

➤ The bottle neck provides easy filling and pouring. Their square shape offers maximum space saving. Caps are made from polyethylene with large ridges for fast closure.

➤ Embossed volume graduations on wall side offer better liquid level viewing.

| catalogue number | volume | neck size | bottle W x L x H (mm) | pack quantity | box quantity |
|------------------|---------|-----------|-----------------------|---------------|--------------|
| 061.09.125 | 125 ml | 32 mm | 53x53x105 | 36 pieces | 144 pieces |
| 061.09.250 | 250 ml | 32 mm | 59x59x147 | 32 pieces | 96 pieces |
| 061.09.500 | 500 ml | 32 mm | 77x77x174 | 32 pieces | 96 pieces |
| 061.09.901 | 1000 ml | 32 mm | 93x93x214 | 24 pieces | 48 pieces |



BOTTLES - "for water sampling" - "polypropylene"



➤ Manufactured from polypropylene for taking, transporting and storing of water samples for microbiological analysis. They can be used for all analysis where a sterile sample is required.

➤ Bottles are manufactured at aseptically sterile production halls and then sent to gamma sterilisation. Such informations as lot number, production and expiry dates etc are indicated on the packing.

➤ Square bottle form offers easy handling and optimum space saving solutions. GL 50 wide bottle neck provides easy filling and pouring.

➤ Cap with large ridges with increased grip featured with self lock and internal security ring. Cap inner design ensures hermetical and leak-proof closure. Caps are made of polyethylene.

➤ Embossed volume graduations on wall side offer better liquid level viewing.

➤ **Alternative 2 bottles:** ➤ **Without sodium thiosulfate**
➤ **With sodium thiosulfate**

➤ Bottles with sodium thiosulfate (20 mg/lit - according to ISO/FIS 19458/2006 standard) are ideal for water analysis where chlorine may modify the composition of the sample.

➤ **"Bulk packed", where bottles are packed as a group in a box.**

➤ **Alternative 2 packing:**

➤ **"Single packed", where bottles are first individually packed in P.E bags and then repacked in a box.**

➤ **Alternative 2 colors:** ➤ **Clear bottles**
➤ **Amber bottles**

➤ Clear bottles are manufactured from very clear P.P resulting with high transparency and for better view of the bottle content.

➤ Amber bottles are manufactured from special formulated P.P preventing UV light penetration into the flask yet still offering high transparency.

"Single packed", where bottles are first individually packed in P.E bags and then repacked in a box.



Self sealing lock caps with integral security ring. Cap inner design ensures hermetical closure and guarantees an excellent leak proof closure.



Cap with large ridges with increased grip featured with self lock and internal security ring. Cap inner design ensures hermetical, leak-proof closure.

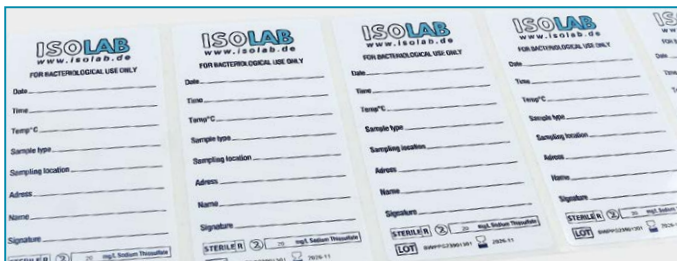

Each bottle is labelled specifying sample and source descriptions, code and lot numbers, expiry date and other informations.



| bulk packed bottles | bottle volume | bottle dimensions | clear bottles W/O sodium thiosulfate | clear bottles with sodium thiosulfate | amber bottles W/O sodium thiosulfate | amber bottles with sodium thiosulfate | packing specifications |
|---------------------|---------------|-------------------|--------------------------------------|---------------------------------------|--------------------------------------|---------------------------------------|------------------------|
| | 125 ml | 57 x 57 x 90 mm | 061.21.125 | 061.23.125 | 061.22.125 | 061.24.125 | 180 pcs in box |
| | 250 ml | 60 x 60 x 115 mm | 061.21.250 | 061.23.250 | 061.22.250 | 061.24.250 | 108 pcs in box |
| | 500 ml | 70 x 70 x 145 mm | 061.21.500 | 061.23.500 | 061.22.500 | 061.24.500 | 84 pcs in box |
| | 1000 ml | 90 x 90 x 175 mm | 061.21.901 | 061.23.901 | 061.22.901 | 061.24.901 | 30 pcs in box |

| single packed bottles | bottle volume | bottle dimensions | clear bottles W/O sodium thiosulfate | clear bottles with sodium thiosulfate | amber bottles W/O sodium thiosulfate | amber bottles with sodium thiosulfate | packing specifications |
|-----------------------|---------------|-------------------|--------------------------------------|---------------------------------------|--------------------------------------|---------------------------------------|------------------------|
| | 125 ml | 57 x 57 x 90 mm | 061.25.125 | 061.27.125 | 061.26.125 | 061.28.125 | 130 pcs in box |
| | 250 ml | 60 x 60 x 115 mm | 061.25.250 | 061.27.250 | 061.26.250 | 061.28.250 | 72 pcs in box |
| | 500 ml | 70 x 70 x 145 mm | 061.25.500 | 061.27.500 | 061.26.500 | 061.28.500 | 42 pcs in box |
| | 1000 ml | 90 x 90 x 175 mm | 061.25.901 | 061.27.901 | 061.26.901 | 061.28.901 | 22 pcs in box |

BOTTLES - "for water sampling" - "PET"



➤ Manufactured from transparent PET with thick walls and crush-resistant corners.

➤ Ideal for taking, transporting and storing of samples for microbiological analysis.

➤ They can be used for all analysis where a sterile sample is required.

➤ Crystall clear bottle body enables the user to visibly check the sample integrity.

➤ All other technical and physical specs are similar as P.P bottles.

| bulk packed bottles | bottle volume | bottle dimensions | clear bottles W/O sodium thiosulfate | clear bottles with sodium thiosulfate | packing specifications |
|---------------------|------------------|-------------------|--------------------------------------|---------------------------------------|------------------------|
| | 125 ml | 56 x 56 x 90 mm | 061.61.125 | 061.63.125 | 180 pcs in box |
| 250 ml | 60 x 60 x 116 mm | 061.61.250 | 061.63.250 | 108 pcs in box | |
| 500 ml | 70 x 70 x 145 mm | 061.61.500 | 061.63.500 | 84 pcs in box | |
| 1000 ml | 90 x 90 x 174 mm | 061.61.901 | 061.63.901 | 30 pcs in box | |

| single packed bottles | bottle volume | bottle dimensions | clear bottles W/O sodium thiosulfate | clear bottles with sodium thiosulfate | packing specifications |
|-----------------------|------------------|-------------------|--------------------------------------|---------------------------------------|------------------------|
| | 125 ml | 56 x 56 x 90 mm | 061.65.125 | 061.67.125 | 130 pcs in box |
| 250 ml | 60 x 60 x 116 mm | 061.65.250 | 061.67.250 | 72 pcs in box | |
| 500 ml | 70 x 70 x 145 mm | 061.65.500 | 061.67.500 | 42 pcs in box | |
| 1000 ml | 90 x 90 x 174 mm | 061.65.901 | 061.67.901 | 22 pcs in box | |



CONTAINER CUP

➤ Manufactured from clear polypropylene with 40 ml effective volume.

➤ The press-on cap ensures hermetical and leak-proof closure. Scale on side wall for easy volume identification.

➤ Frosted marking area on side wall enables easy marking and labelling.

JARS
"glass" - "wide neck"

➤ Manufactured from neutral glass with thick walls and crush-resistant corners.

➤ Ideal for safe storage and transportation of liquids and powders.

➤ Enamelled steel cap inner design ensures hermetical and leak-proof closure.

| catalogue number | product description | pack quantity |
|------------------|----------------------|---------------|
| 087.02.001 | non-sterile cups | 1000 pieces |
| 087.02.002 | aseptic sterile cups | 500 pieces |

| catalogue number | volume | jar diameter | pack quantity |
|------------------|---------|--------------|---------------|
| 061.29.040 | 40 ml | 43 mm | 10 pieces |
| 061.29.105 | 105 ml | 49 mm | 10 pieces |
| 061.29.370 | 370 ml | 72 mm | 10 pieces |
| 061.29.720 | 720 ml | 90 mm | 10 pieces |
| 061.29.901 | 1000 ml | 95 mm | 10 pieces |



BOTTLES - "spray"

- Manufactured from transparent PET with a spray head.
- All media contacting parts perfectly resist to most solvents and chemicals.
- Liquids can be finely vaporised with the pull of the hand pump trigger.
- Feature with a safety lock at the trigger which prevents accidental use.

| catalogue number | volume | pack quantity |
|------------------|--------|---------------|
| 062.11.250 | 250 ml | 1 piece |
| 062.11.500 | 500 ml | 1 piece |

Extremely fine and homogenous vaporisation is guaranteed with the pull of the trigger.



WASH BOTTLES - "integral"

- Manufactured from highly translucent polyethylene. Ergonomic shape offers easy grip and easy squeeze during use.
- Integral moulded delivery tube delivers the liquid in the bottle until the last drop.
- Delivery tube guarantees a fine and straight flow with an application of a slight pressure on the body.

| catalogue number | volume | pack quantity |
|------------------|--------|---------------|
| 062.08.250 | 250 ml | 1 piece |
| 062.08.500 | 500 ml | 1 piece |



Dispensing tip provides extra fine stream. The tip of the delivery tube can be cut in order to increase the liquid flow rate.



WASH BOTTLES - "narrow neck"

- Manufactured from highly translucent and semi-rigid polyethylene with thick walls and crush-resistant corners.
- Round bottle form allows un-restricted liquid flow-out without leaving any residue at the bottle neck.
- Flexible delivery tube guarantees a fine and straight flow with an application of a slight pressure on the body.
- "Goose neck" design of the delivery tube guarantees easy and precise reaching to the flask corners.
- Dispensing tip provides extra fine stream.
- Delivery tube tip can be cut to increase the flow rate.

Colored body and caps enables fast, and easy identification of bottle content.



| clear bottles | volume | coloured bottles | volume | bottle color | pack quantity |
|---------------|---------|------------------|--------|--------------|---------------|
| 062.05.100 | 100 ml | 062.05.05R | 500 ml | red | 1 piece |
| 062.05.250 | 250 ml | 062.05.05Y | 500 ml | yellow | 1 piece |
| 062.05.500 | 500 ml | 062.05.05G | 500 ml | green | 1 piece |
| 062.05.901 | 1000 ml | 062.05.05B | 500 ml | blue | 1 piece |





WASH BOTTLES - "wide neck" - "multi-color cap"

- Manufactured from highly translucent and semi-rigid polyethylene with thick walls and crush-resistant corners.
- Round bottle form allows unrestricted liquid flow out without leaving any residue at the bottle neck.
- Angled delivery tube guarantees a fine and straight flow with an application of a slight pressure on the body.
- Dispensing tube design offers optimum backflow and turbulence free liquid transfer.
- Caps acupled with delivery tube are made from polyethylene with large ridges with increased grip. Cap inner design ensures hermetical and leak-proof closure.



Colored caps enables easy identification of the bottle content. Ribbed cap provides perfect grip.

| catalogue number | volume | cap color | pack quantity |
|------------------|--------|-----------|---------------|
| 062.09.05R | 500 ml | red | 1 piece |
| 062.09.05Y | 500 ml | yellow | 1 piece |
| 062.09.05G | 500 ml | green | 1 piece |
| 062.09.05B | 500 ml | blue | 1 piece |

WASH BOTTLES - "wide neck" - "multilingual"

- Manufactured from highly translucent and semi-rigid polyethylene and polypropylene according to European safety regulations (EC)1272/2008(GHS).
- Angled delivery tube guarantees a fine and straight flow with an application of a slight pressure on the body.
- Dispensing tube design offers turbulence free liquid transfer.
- Caps acupled with delivery tube are made from polyethylene with large ridges with increased grip.
- Cap inner design ensures leak-proof closure.
- Chemical names, formulas, CAS numbers and other key safety informations are printed on the body surface in 4 (English / French / German and Spanish) languages.



Warning words as "flammable", to identify the the hazardous liquids, "how-to-use" instructions in four languages are printed on the body.

Chemical names, formulas, CAS numbers and pictograms showing the latest changes in regulations are printed on the body.

| catalogue number | wash bottle label name | bottle material | bottle volume | cap color | pack quantity |
|------------------|------------------------|-----------------|---------------|-----------|---------------|
| 062.50.500 | acetone | P.P | 500 ml | red | 1 piece |
| 062.51.500 | water | P.E | 500 ml | blue | 1 piece |
| 062.51.501 | distilled water | P.E | 500 ml | blue | 1 piece |
| 062.51.502 | deionised water | P.E | 500 ml | blue | 1 piece |
| 062.52.500 | ethanol | P.E | 500 ml | green | 1 piece |
| 062.53.500 | ethyl acetate | P.E | 500 ml | white | 1 piece |
| 062.54.500 | iso-propanol | P.E | 500 ml | yellow | 1 piece |
| 062.55.500 | methanol | P.E | 500 ml | orange | 1 piece |
| 062.56.500 | methylethylketone | P.P | 500 ml | brown | 1 piece |
| 062.57.500 | tetrahydrofuran | P.P | 500 ml | black | 1 piece |
| 062.58.500 | toluene | P.E | 500 ml | torquise | 1 piece |

JERRYCANS - "polyethylene"



- Manufactured from UV stabilised, thick polyethylene with sturdy carrying handles.
- Featured with a wide neck for easy filling and draining.
- Caps are made from polypropylene with large ridges with increased grip.
- Cap with self-locking internal security ring ensures leak-proof closure.
- 20 and 30 lt jerrycans are featured with a leak-proof stopcock which prevents vacuum formation during draining.



Caps are made from polypropylene with large ridges for increased grip.

| catalogue number | volume | pack quantity |
|------------------|--------|---------------|
| 062.21.902 | 2 L | 1 piece |
| 062.21.903 | 3 L | 1 piece |
| 062.21.905 | 5 L | 1 piece |
| 062.21.910 | 10 L | 1 piece |
| 062.21.920 | 20 L | 1 piece |
| 062.21.930 | 30 L | 1 piece |

CARBOYS - "aspirator bottles" - "with stopcock" - "polypropylene"



- Manufactured from UV stabilised, thick polypropylene with sturdy carrying handles.
- Featured with a wide neck for easy filling and draining.
- Caps are made from polypropylene with large ridges with increased grip. Cap ensures leak-proof closure.
- Featured with a leak-proof stopcock.



Caps are made from polypropylene with large ridges with increased grip.



Featured with a leak-proof stopcock which prevents vacuum formation during draining.

| catalogue number | volume | carboy Ø | carboy H | cap Ø | pack quantity |
|------------------|--------|----------|----------|-------|---------------|
| 062.28.905 | 5 L | 170 mm | 345 mm | 55 mm | 1 piece |
| 062.28.910 | 10 L | 200 mm | 455 mm | 55 mm | 1 piece |
| 062.28.920 | 20 L | 265 mm | 550 mm | 55 mm | 1 piece |

BOTTLES - "aspirator" - "with stopcock" - "glass"



- Manufactured from heat resistant, durable borosilicate glass with thick wall, heavy base and reinforced rim.
- Featured with a wide neck for easy filling and draining.
- Caps are made from polypropylene with large ridges with increased grip.
- Cap inner design ensures leak-proof closure.
- Featured with a leak-proof stopcock.



Caps are made from polypropylene with large ridges with increased grip.



Featured with a leak-proof stopcock which prevents vacuum formation during draining.

| catalogue number | volume | pack quantity |
|------------------|--------|---------------|
| 062.27.905 | 5 L | 1 piece |
| 062.27.910 | 10 L | 1 piece |
| 062.27.920 | 20 L | 1 piece |

BOTTLES - "dropping"



➤ Manufactured from transparent polyethylene with a dropping cap. Cap can be easily dismantled for cleaning.

➤ Dispensing tip provides similar size drops at all times. Supplied with a push-to-open cap for safety reasons.

| catalogue number | volume | pack quantity |
|------------------|--------|---------------|
| 062.10.010 | 10 ml | 10 pieces |
| 062.10.015 | 15 ml | 10 pieces |
| 062.10.020 | 20 ml | 10 pieces |
| 062.10.030 | 30 ml | 10 pieces |



BOTTLES - "dropping"



Dispensing tip provides always similar size drops at all times.

➤ Manufactured from heat resistant, durable borosilicate glass with a glass dropping cap.

➤ Dispensing tip provides similar size drops at all times.

➤ Amber bottles prevent UV lights to penetrate into the bottle.

| clear bottles | amber bottles | volume | pack quantity |
|---------------|---------------|--------|---------------|
| 062.02.100 | 062.03.100 | 100 ml | 1 piece |



BOTTLES - "dropping"



Dispensing tip provides always similar size drops at all times.

➤ Manufactured from heat resistant, durable borosilicate glass with a rubber dropping cap. Cap can be easily dismantled for cleaning.

➤ Dispensing tip provides similar size drops at all times.

➤ Amber bottles prevent UV lights to penetrate into the bottle.

| clear bottles | amber bottles | volume | pack quantity |
|---------------|---------------|--------|---------------|
| 062.12.050 | 062.13.050 | 50 ml | 1 piece |
| 062.12.100 | 062.13.100 | 100 ml | 1 piece |

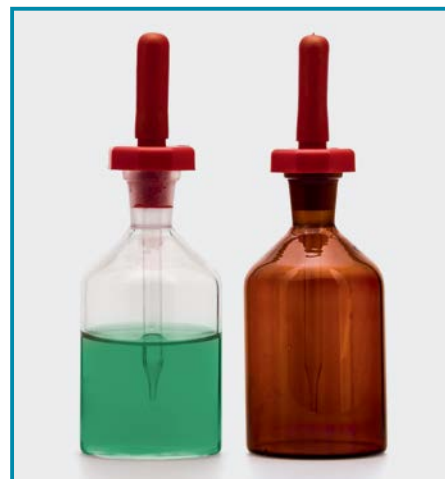

BOTTLES - "dropping"



Dispensing tip provides always similar size drops at all times.

➤ Manufactured from transparent polyethylene with a dropping cap. Cap can be easily dismantled for cleaning.

➤ Dispensing tip provides similar size drops at all times. The dispensing tip can be cut to increase the drop volume

➤ Amber bottles prevent UV lights to penetrate into the bottle.

| clear bottles | amber bottles | volume | pack quantity |
|---------------|---------------|--------|---------------|
| 062.04.100 | 062.04.101 | 100 ml | 1 piece |



CARRIERS - "for bottles"



► Manufactured from epoxy coated steel wire for safe transportation of 500 ml, 1 lt and 2,5 lt standard chemical bottles.

► Easy to grab sturdy handle offers perfect balance and comfort during use.

| catalogue number | for bottle max. dia. | bottle array | pack quantity |
|------------------|----------------------|--------------|---------------|
| 062.66.500 | 100 mm | 6 x 500 ml | 1 piece |
| 062.66.901 | 105 mm | 4 x 1000 ml | 1 piece |
| 062.66.902 | 140 mm | 2 x 2500 ml | 1 piece |



TRANSPORT BOX

► Manufactured from polypropylene for storing and transporting small size products.

► Clasp lid ensures safe closure and guarantees the interior being not effected by dust, humidity and other enviromental conditions.

► The clarity of the box enables the user to visibly check the sample integrity and use the box safely.

► Carry handle folds neatly allowing the boxes can be stacked on each other.

► The lid can open fully 180° offering easy access to the contents and easy cleaning of interior.

| catalogue number | pack quantity |
|------------------|---------------|
| 062.66.004 | 1 piece |



BASKET - "for bottles"

► Manufactured from ABS for safe and convenient transportation up to 6 wash bottles.

► Although highly recommended for 500 ml bottles can also carry 250 ml bottles.

► Strong, light weight body construction and ergonomic handle offer both comfort and control.

► Easily stackable due to the tapered body form for reducing storage space.

| catalogue number | for bottle max. diameter | pack quantity |
|------------------|--------------------------|---------------|
| 062.66.001 | 90 mm | 1 piece |

BOX - "with compartments" - "acrylic"



► Manufactured from acrylic featured with different size compartments.

► Offers practical positioning of different size small objects such as magnetic stirrers.

► The long compartment is ideal to store longer objects including magnetic bar retrievers.

► Featured with a lid protecting the box interior.

| catalogue number | box width | box length | box height | compartment quantity | pack quantity |
|------------------|-----------|------------|------------|----------------------|---------------|
| 057.02.101 | 330 mm | 110 mm | 35 mm | 12 | 1 piece |

DISPENSER BOXES



➤ Manufactured from crystal clear acrylic with excellent field of vision.

➤ Ideal assistants for storing and dispensing small sized products such as pipette tips, tubes, vials and many others.

➤ Generous openings provide easy and safe access to partiations.

➤ Covers are featured with easy opening hinged lids. Once opened, the lid stands open and enables easy handling.

➤ Their flip-top covers guarantee safe and clean storage without been effected from enviromental effects.

➤ Featured with non-skid silicone feet for safe and stable stand on the desks.

| catalogue number | specifications | external dimensions | pack quantity |
|------------------|----------------|---------------------|---------------|
| 006.15.001 | 1 compartment | 175 x 250 x 330 mm | 1 piece |
| 006.15.002 | 2 compartments | 175 x 250 x 330 mm | 1 piece |
| 006.15.003 | 3 compartments | 265 x 250 x 330 mm | 1 piece |



BOXES - "double opening"

➤ Manufactured from polypropylene for storing and transporting all products including food stuff.

➤ Clasping lid ensures safe closure and guarantees the interior being not effected by dust, humidity and other enviromental conditions.

➤ The clarity of the box enables the user to visibly check the sample integrity and safe use of the box safely.

➤ Easily stackable due to the tapered body form for reducing storage space.

➤ The lid can open fully 180° with two steps offering easy access to the contents and easy cleaning of interior.



| catalogue number | dimensions (mm) | box volume | pack quantity |
|------------------|-----------------|------------|---------------|
| 062.39.900 | 95 x 150 x 75 | 0,75 L | 1 piece |
| 062.39.901 | 125 x 185 x 65 | 1,00 L | 1 piece |
| 062.39.902 | 125 x 185 x 90 | 1,50 L | 1 piece |
| 062.39.903 | 155 x 230 x 110 | 3,00 L | 1 piece |
| 062.39.905 | 200 x 280 x 125 | 5,00 L | 1 piece |
| 062.39.907 | 255 x 355 x 122 | 7,50 L | 1 piece |
| 062.39.910 | 250 x 345 x 150 | 10,00 L | 1 piece |
| 062.39.913 | 255 x 355 x 200 | 13,00 L | 1 piece |



BOXES - "click lock lid"

➤ Manufactured from polypropylene for easy and safe storage of most products.

➤ "Click-lock" system enables safe closure and easy opening of the box lid.

➤ The clarity of the box enables the user to visibly check the sample integrity and safe use of the box.

➤ Easily stackable due to the tapered body form for reducing storage space.

| catalogue number | dimensions (mm) | box volume | pack quantity |
|------------------|-----------------|------------|---------------|
| 062.36.910 | 385 x 260 x 155 | 10 L | 1 piece |
| 062.36.920 | 460 x 320 x 180 | 20 L | 1 piece |
| 062.36.930 | 510 x 355 x 230 | 30 L | 1 piece |



TEST TUBES - "glass"

- Manufactured by automated machines with consistent length and thickness.
- Due to the properties of borosilicate glass highly recommended for over heated applications.

| tube dimensions | neutral glass test tubes | borosilicate glass tubes | pack quantity |
|-----------------|--------------------------|--------------------------|---------------|
| 6 x 40 mm | 077.01.000 | | 100 pieces |
| 10 x 75 mm | 077.01.001 | 077.02.001 | 100 pieces |
| 12 x 75 mm | 077.01.021 | | 100 pieces |
| 12 x 100 mm | 077.01.002 | 077.02.002 | 100 pieces |
| 13 x 100 mm | 077.01.003 | 077.02.003 | 100 pieces |
| 13 x 130 mm | 077.01.031 | | 100 pieces |
| 16 x 100 mm | 077.01.004 | 077.02.004 | 100 pieces |
| 16 x 160 mm | 077.01.005 | 077.02.005 | 100 pieces |
| 18 x 180 mm | 077.01.006 | 077.02.006 | 100 pieces |
| 20 x 200 mm | 077.01.007 | | 100 pieces |
| 20 x 220 mm | 077.01.008 | | 100 pieces |

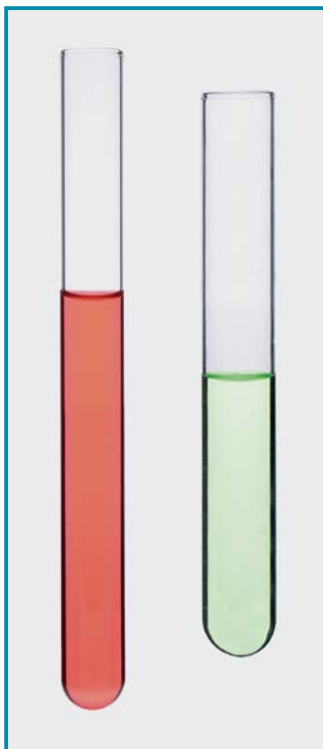

TEST TUBES - "P.P or P.S"

- Manufactured from clear polypropylene or from polystyrene for disposable use.

| PS tubes | PP tubes | tube dimensions | bottom form | pack quantity |
|------------|------------|-----------------|-------------|---------------|
| 077.04.001 | 077.04.002 | 12x75 mm | round | 1000 pieces |
| 077.04.003 | 077.04.004 | 16x100 mm | round | 500 pieces |
| 077.04.005 | 077.04.006 | 16x100 mm | conical | 500 pieces |

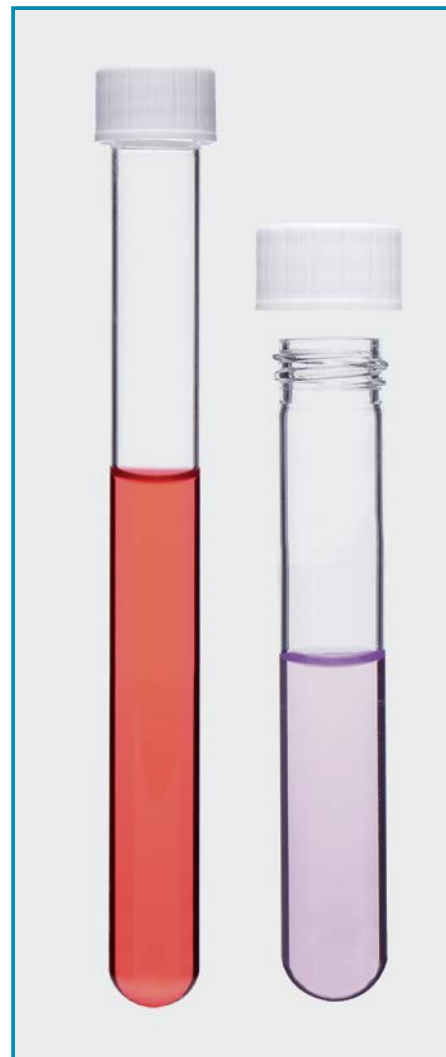

TEST TUBES "glass" - "with screw cap"

- Manufactured from neutral glass featured with a polypropylene screw cap.
- Hermetic caps guarantee absolute leak-proof closure.
- Specially recommended for tissue culture or other similar applications.
- Tubes and caps are delivered in separate packings.

| catalogue number | tube dimensions | pack quantity |
|------------------|-----------------|---------------|
| 077.03.001 | 16x100 mm | 100 pieces |
| 077.03.002 | 16x160 mm | 100 pieces |

CENTRIFUGE TUBES - "glass"

- Manufactured from neutral glass with wall thickness 1,0 - 1,1 mm.
- Nominal capacity is approximately 15 ml. They stand up to 3.500 RCF and guarantee problem free centrifugation.

| tube centrifuge | tube dimensions | product specifications | pack quantity |
|-----------------|-----------------|------------------------|---------------|
| 078.01.001 | 16x100 mm | non-graduated | 100 pieces |
| 078.01.002 | 16x100 mm | graduated | 10 pieces |

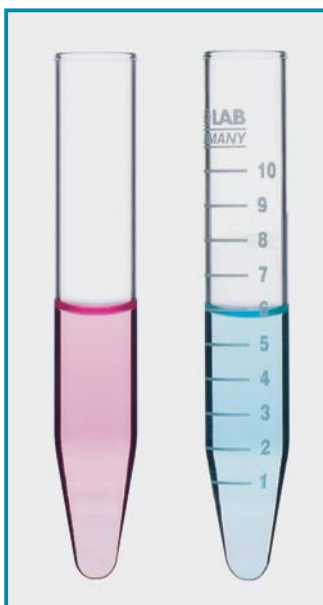

Various beaker tongs can be selected from catalogue page no 69.

TUBE RACKS - "epoxy coated steel"

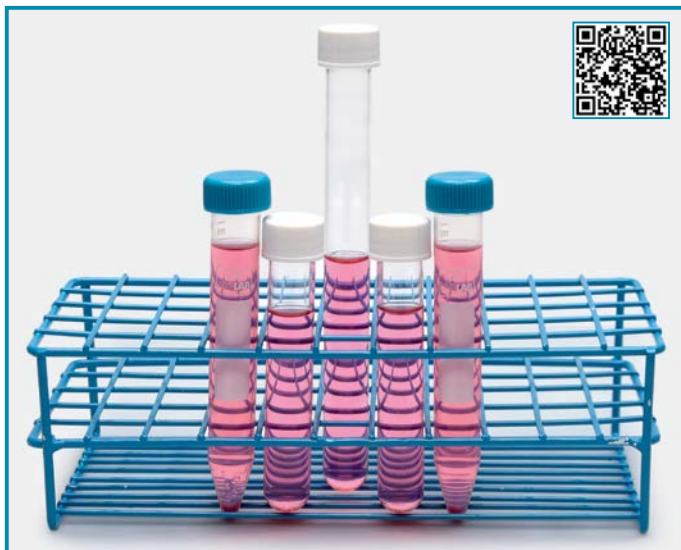

- They offer ideal solutions with square tube holes, reinforced edges and slotted bottom design for secure handling.
- Manufactured from high quality steel wire, welded and coated with heat cured blue epoxy.
- The epoxy coating is absolutely corrosion proof and can resist to salts, moderate acids, moderate alkalis and organic solvents.
- Ideal for autoclaving. Can resist from -200°C to +121°C.



Square tube holes and slotted bottom design guarantees firm hold of the tubes at exact positions.

| catalogue number | for tubes | well quantity | tube array | rack L x W x H | pack quantity |
|------------------|-----------|---------------|------------|----------------|---------------|
| 079.01.101 | 13 mm | 84 | 6 x 14 | 100x231x68 mm | 1 piece |
| 079.01.102 | 16 mm | 55 | 5 x 11 | 118x260x74 mm | 1 piece |
| 079.01.103 | 18 mm | 55 | 5 x 11 | 110x235x75 mm | 1 piece |
| 079.01.104 | 20 mm | 40 | 4 x 10 | 100x235x70 mm | 1 piece |
| 079.01.105 | 25 mm | 32 | 4 x 8 | 116x230x93 mm | 1 piece |
| 079.01.106 | 30 mm | 21 | 3 x 7 | 110x260x95 mm | 1 piece |

TUBE RACKS - "with silicone grips"



- Manufactured from modified ABS which enables the racks to be used in water baths without floating.
- Bottom of each tube compartment is featured with a silicone grip that firmly holds the tubes in position without wobble.
- Tubes can be inserted and extracted with a gentle push or pull.



PUSH & EJECT function

Just simply press upwards the bottom layer of the tube rack by two hands. The eject mechanism automatically releases the tubes from their positions simultaneously and immediately.



SILICONE GRIP function

Bottom of each tube compartment is featured with a silicone grip that firmly holds the tubes in position without wobble.

| catalogue number | tube diameter | tube qty | tube array | pack quantity |
|------------------|---------------|----------|------------|---------------|
| 079.11.016 | 15/16 mm | 50 | 5x10 | 1 piece |

TUBE RACKS - "st. steel"



- Manufactured from high quality, chemical and corrosion resistant AISI 304 grade stainless steel.
- Robust and seamless construction guarantees long life cycle. Smooth polished surface provides fast and easy cleaning.
- Offers a very long life cycle due to the very robust construction.
- Perfect design of the tube holes firmly keeps the tubes at their position.

| catalogue number | tube diameter | tube quantity | tube array | pack quantity |
|------------------|---------------|---------------|------------|---------------|
| 079.02.001 | 13 mm | 50 | 5x10 | 1 piece |
| 079.02.002 | 16 mm | 50 | 5x10 | 1 piece |
| 079.02.003 | 18 mm | 40 | 4x10 | 1 piece |

TUBE RACKS - "polypropylene" - "dismantled"



➤ Manufactured from modified polypropylene which enables the racks to be used in water baths without floating.

➤ Guarantees temperature resistance between -20°C to +121°C.

➤ 4 different color options offer visual sorting and organising of different samples.

➤ The alpha numeric grid reference on the top tier of the rack ensures an easy tube location and sample positioning.

➤ Racks are supplied dismantled for reducing storage area.

➤ Racks can be easily assembled less than half a minute with the help of supplied instruction manual.

| item no | for tubes | well quantity | tube array | rack L x W x H | white racks catalogue no | blue racks catalogue no | red racks catalogue no | orange racks catalogue no | pack quantity |
|---------|-----------|---------------|------------|----------------|--------------------------|-------------------------|------------------------|---------------------------|---------------|
| 1 | 13 mm | 84 | 6 x 14 | 125x265x70 mm | 079.01.001W | 079.01.001B | 079.01.001R | 079.01.001O | 1 piece |
| 2 | 16 mm | 55 | 5 x 11 | 125x265x70 mm | 079.01.002W | 079.01.002B | 079.01.002R | 079.01.002O | 1 piece |
| 3 | 18 mm | 55 | 5 x 11 | 125x265x70 mm | 079.01.003W | 079.01.003B | 079.01.003R | 079.01.003O | 1 piece |
| 4 | 20 mm | 40 | 4 x 10 | 125x265x70 mm | 079.01.004W | 079.01.004B | 079.01.004R | 079.01.004O | 1 piece |
| 5 | 25 mm | 32 | 4 x 8 | 125x265x90 mm | 079.01.005W | 079.01.005B | 079.01.005R | 079.01.005O | 1 piece |
| 6 | 30 mm | 21 | 3 x 7 | 125x265x90 mm | 079.01.006W | 079.01.006B | 079.01.006R | 079.01.006O | 1 piece |

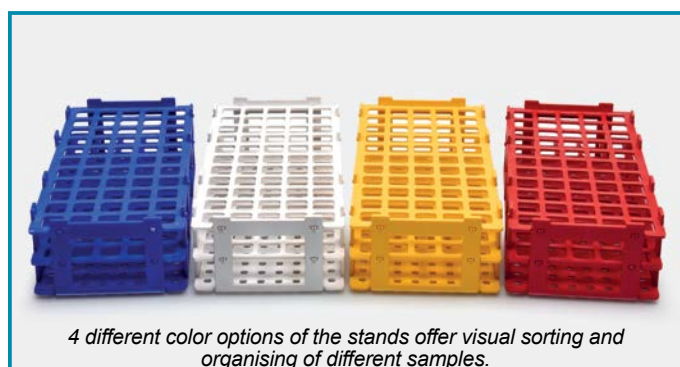
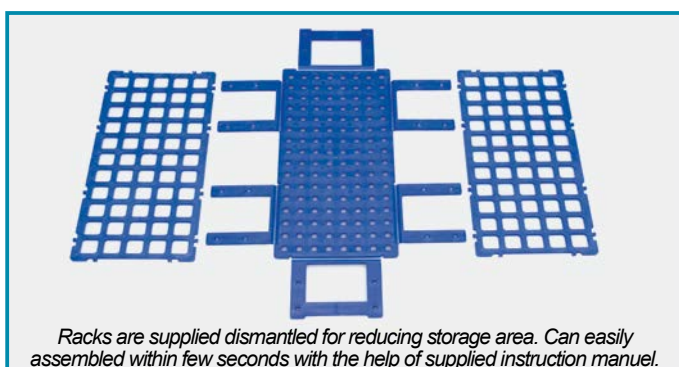

TUBE RACK - "4 sides"

➤ Manufactured from modified polypropylene which enables the racks to be used in water baths without floating.

➤ 4 sides offer 4 different tube holding alternative.

- Side 1: holds 4 x 30 mm dia. tube with 2 x 2 array
- Side 2: holds 32 x 12 mm dia. tube with 4 x 8 array
- Side 3: holds 12 x 17 mm dia. tube with 2 x 6 array
- Side 4: holds 96 x 7 mm dia. tube with 8 x 12 array

➤ Racks are designed with an interlocking system for connection to each other in order to form multi rack rows.

➤ Alphanumeric index on tube rows enables easy identification of tube positions.

| catalogue number | tube diameter | tube volume | tube quantity | tube array | pack quantity |
|------------------|---------------|-------------|---------------|------------|---------------|
| 080.01.001 | 30 mm | 50 ml | 4 | 2 x 2 | 1 piece |
| | 12 mm | | 32 | 4 x 8 | |
| | 17 mm | 15 ml | 12 | 2 x 6 | |
| | 7 mm | | 96 | 8 x 12 | |



TUBE RACKS - "polypropylene" - "foldable"



➤ Manufactured from modified polypropylene which enables the racks to be used in water baths without floating.

➤ Guarantees temperature resistance between -20°C to +121°C.

➤ 4 different color options offer visual sorting and organising of different samples.

➤ Raised tube sockets guarantee firm hold of the tubes at their exact positions.

➤ The alpha numeric grid reference on the top tier of the rack ensures an easy tube location and sample positioning.

➤ Racks are supplied assembled and folded. Can be ready for use in few seconds with a simple action.

➤ These racks can be folded after use for reducing storage area.

| for tubes | well quantity | tube array | rack L x W x H | white racks catalogue no | blue racks catalogue no | red racks catalogue no | orange racks catalogue no | pack quantity |
|-----------|---------------|------------|----------------|--------------------------|-------------------------|------------------------|---------------------------|---------------|
| 13 mm | 50 | 5 x 10 | 140x275x70 mm | 079.03.001W | 079.03.001B | 079.03.001R | 079.03.001O | 1 piece |
| 16 mm | 50 | 5 x 10 | 140x275x70 mm | 079.03.002W | 079.03.002B | 079.03.002R | 079.03.002O | 1 piece |
| 18 mm | 50 | 5 x 10 | 140x275x70 mm | 079.03.003W | 079.03.003B | 079.03.003R | 079.03.003O | 1 piece |
| 20 mm | 45 | 5 x 9 | 140x275x70 mm | 079.03.004W | 079.03.004B | 079.03.004R | 079.03.004O | 1 piece |
| 30 mm | 26 | 4 x 6/7 | 140x275x70 mm | 079.03.005W | 079.03.005B | 079.03.005R | 079.03.005O | 1 piece |

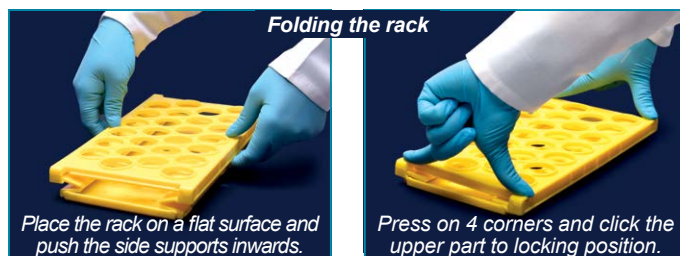
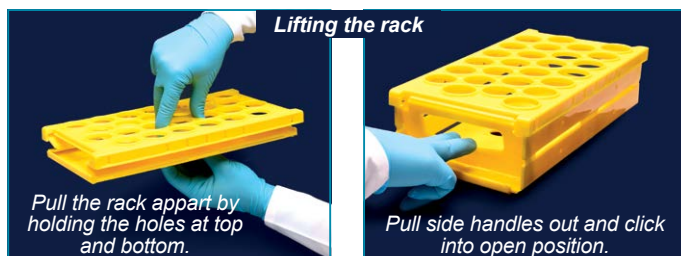



STANDS - "rectangular"

- Highly stable rectangular base is manufactured from enamel coated sheet steel.
- Silicone feet placed under the base prevents the stand from sliding.
- Supplied without rods. Kindly select the suitable rod from below table.

| catalogue number | dimensions | pack quantity |
|------------------|--------------|---------------|
| 049.01.130 | 130 x 210 mm | 1 piece |
| 049.01.150 | 150 x 300 mm | 1 piece |
| 049.01.200 | 200 x 315 mm | 1 piece |

SUPPORT RODS

- Manufactured either from galvanised steel or stainless steel with a M10 thread.

| galvanised steel | rod length | rod diameter | pack quantity |
|------------------|------------|--------------|---------------|
| 049.06.004 | 600 mm | 12 mm | 1 piece |
| 049.06.005 | 750 mm | 12 mm | 1 piece |
| 049.06.006 | 1000 mm | 12 mm | 1 piece |

| stainless steel | rod length | rod diameter | pack quantity |
|-----------------|------------|--------------|---------------|
| 049.07.004 | 600 mm | 12 mm | 1 piece |
| 049.07.005 | 750 mm | 12 mm | 1 piece |
| 049.07.006 | 1000 mm | 12 mm | 1 piece |

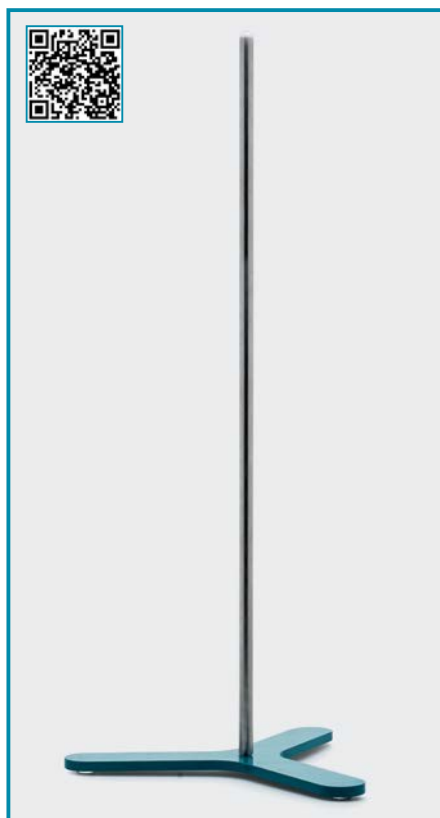

STANDS - "triangle"

- Highly stable triangle base is manufactured from enamel coated sheet steel.
- Silicone feet placed under the base prevents the stand from sliding.
- Supplied without rods. Kindly select the suitable rod from below table.

| catalogue number | foot length | base thickness | pack quantity |
|------------------|-------------|----------------|---------------|
| 049.03.115 | 115 mm | 8 mm | 1 piece |
| 049.03.150 | 150 mm | 8 mm | 1 piece |

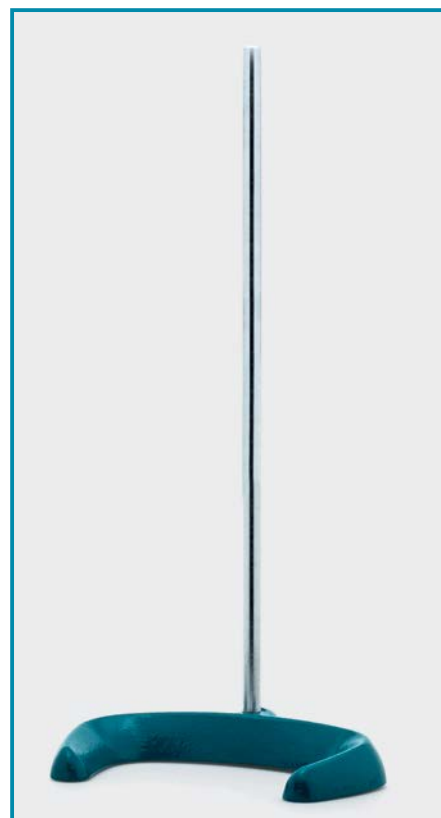

STANDS - "horse shoe"

- The most sturdy stand type.
- Extremely stable horse shoe base is manufactured from enamel coated cast steel.
- Highly recommended for various applications such as titration, assembly of stirrers etc. Supplied with rods.

| catalogue number | size | rod dia. | rod height | pack quantity |
|------------------|--------|----------|------------|---------------|
| 049.09.180 | small | 12 mm | 600 mm | 1 piece |
| 049.09.250 | medium | 14 mm | 700 mm | 1 piece |
| 049.09.320 | large | 16 mm | 800 mm | 1 piece |



WIRE GAUZES

- Manufactured from galvanised steel with a ceramic circular plate at the center.

| catalogue number | wire gauze dimensions | pack quantity |
|------------------|-----------------------|---------------|
| 050.06.001 | 150x150 mm | 1 piece |

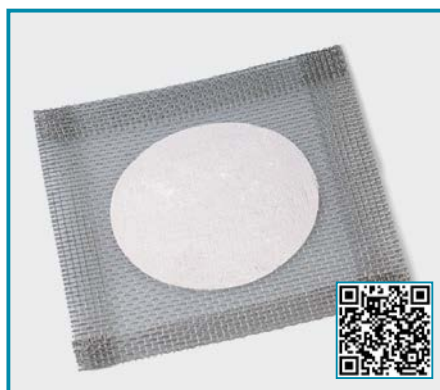



STANDS - "ABS"

- Highly stable rectangular base is manufactured from ABS.
- Base with dimensions 175x300 mm has two rod holding holes.
- Same rod can be placed either at the center or at the rear of the base offering multi advantages.
- White base color guarantees perfect visual observation of color changes during titration applications.
- Delivered complete with a screw-in galvanized support rod of 600 mm height.

| catalogue number | base width | base length | pack quantity |
|------------------|------------|-------------|---------------|
| 049.04.175 | 175 mm | 300 mm | 1 piece |

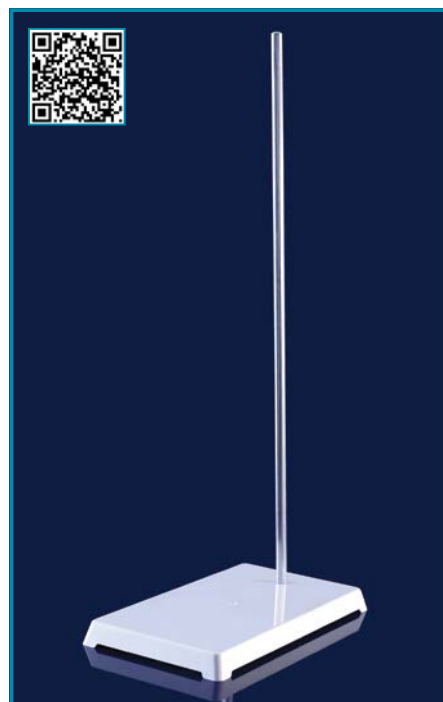

LABORATORY JACKS

- Table and base plate are manufactured from anodized aluminium. Scissors are made from stainless steel.
- Large control knob enables smooth and continuous control of table height.

| catalogue number | plate width | plate length | pack quantity |
|------------------|-------------|--------------|---------------|
| 050.05.150 | 150 mm | 150 mm | 1 piece |
| 050.05.200 | 200 mm | 200 mm | 1 piece |



TRIPOD - "fix height"

- Manufactured from chrome plated steel.
- Holding ring with 125 mm diameter offers practical use with all sizes of ceramic triangles and wire gauzes.

| catalogue number | fix height | pack quantity |
|------------------|------------|---------------|
| 050.04.001 | 200 mm | 1 piece |



150 mm standard diameter of circular ring can be reduced to 125 mm with the help of supplied reduction ring.



TRIPOD - "adjustable height"

- Manufactured from chrome plated steel. Height can be adjustable from 200 mm to 300 mm.
- Holding ring with 150 mm diameter can be reduced to 125 mm with the supplied reduction attachment.

| catalogue number | pack quantity |
|------------------|---------------|
| 050.04.002 | 1 piece |

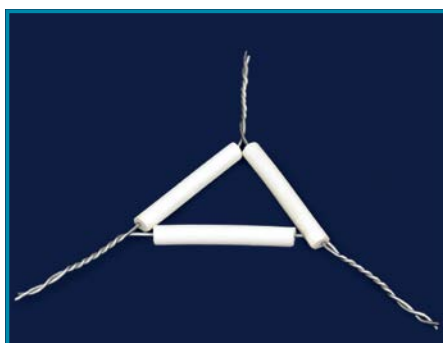

CERAMIC TRIANGLES

- Consists of ceramic pipes around galvanized steel wire.

| catalogue number | ceramic cylinder dimension | pack quantity |
|------------------|----------------------------|---------------|
| 050.07.050 | 50 mm | 1 piece |
| 050.07.060 | 60 mm | 1 piece |



CLAMP - "2 jaws" - "without bosshead"

➤ Manufactured from high quality, corrosion resistant chromated steel holding for various objects in the most secure way.

➤ PVC coated insulated jaws guarantee perfect heat insulation. Soft and elastic coating holds the glassware gently and prevent possible breakage.

➤ Individually adjustable clamps guarantee perfect and precise control of holding pressure and holding position.

➤ Clamps can be opened and closed smoothly with a 50 mm grip diameter.

| catalogue number | pack quantity |
|------------------|---------------|
| 045.01.001 | 1 piece |



CLAMP - "2 jaws" - "with bosshead"

➤ Manufactured from high quality, corrosion resistant chromated steel holding for various objects in the most secure way.

➤ Featured with a swivel bosshead which provides 360° swivel of the clamped object around their axis. Bosshead locking feature guarantees perfect position hold of the clamped objects. Adjustable clamps guarantee perfect pressure control.

➤ PVC coated insulated jaws guarantee perfect heat insulation. Soft coating holds the glassware gently and prevent breakage.

➤ Clamps can be opened and closed smoothly with a 50 mm grip diameter.

| catalogue number | pack quantity |
|------------------|---------------|
| 045.04.001 | 1 piece |



CLAMP - "3 jaws" - "without bosshead"

➤ Manufactured from high quality, corrosion resistant chromated steel holding for various objects in the most secure way.

➤ PVC coated insulated jaws guarantee perfect heat insulation. Soft and elastic coating holds the glassware gently and prevent possible breakage.

➤ Individually adjustable clamps guarantee perfect and precise control of holding pressure and holding position.

➤ Clamps can be opened and closed smoothly with a 70 mm grip diameter.

| catalogue number | pack quantity |
|------------------|---------------|
| 045.03.001 | 1 piece |



CLAMP - "3 jaws" - "with bosshead"

➤ Manufactured from high quality, corrosion resistant chromated steel holding for various objects in the most secure way.

➤ Featured with a swivel bosshead which provides 360° swivel of the clamped object around their axis. Bosshead locking feature guarantees perfect position hold of the clamped objects. Adjustable clamps guarantee perfect pressure control.

➤ PVC coated insulated jaws guarantee perfect heat insulation. Soft coating holds the glassware gently and prevent breakage.

➤ Clamps can be opened and closed smoothly with a 70 mm grip diameter.

| catalogue number | pack quantity |
|------------------|---------------|
| 045.06.001 | 1 piece |



CLAMP - "for frame work"

➤ Manufactured from high quality, corrosion resistant chromated steel.

➤ Ideal for frame works and fixing perpendiculars.

➤ Clamps can be opened and closed smoothly by a screw thread with a 12 mm grip diameter.

| catalogue number | pack quantity |
|------------------|---------------|
| 046.07.001 | 1 piece |

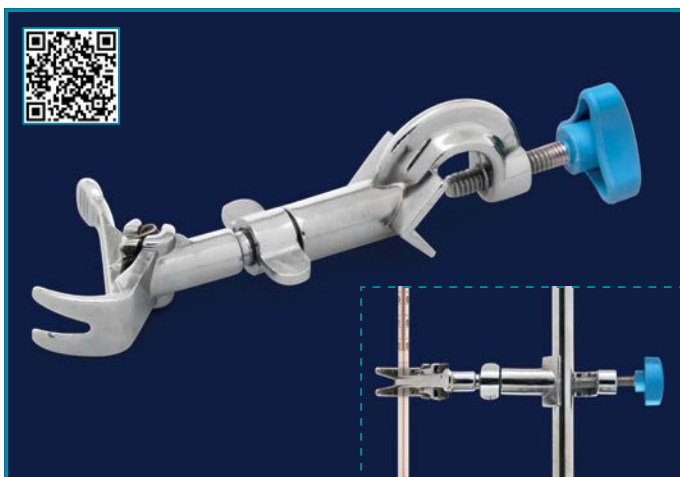

CLAMP - "for thermometers"

- Manufactured from high quality, corrosion resistant chromated steel for holding thermometers in the most secure way.
- Featured with a swivel bosshead which provides 360° swivel of the clamped object around their axis.
- Bosshead locking feature guarantees perfect position hold of the clamped objects.
- Fixing head featured with flexible springs offers easy insertion and extraction of the thermometers.
- Clamps can be opened and closed smoothly with a 30 mm grip diameter.

| catalogue number | pack quantity |
|------------------|---------------|
| 060.04.001 | 1 piece |



BOSSEHEAD - "standard" - "fix position"

- Manufactured from high quality, corrosion resistant chromated steel for holding rods in the most secure way.
- Holds the objects on a fixed position.
- Clamps can be opened and closed smoothly with a 23 mm grip diameter.

| catalogue number | pack quantity |
|------------------|---------------|
| 046.01.001 | 1 piece |



BOSSEHEAD - "heavy duty" - "fix position"

- Manufactured from high quality, corrosion resistant chromated steel for holding rods in the most secure way.
- Holds the objects on a fixed position.
- Clamps can be opened and closed smoothly with a 17 mm grip diameter.

| catalogue number | pack quantity |
|------------------|---------------|
| 046.05.001 | 1 piece |



BOSSEHEAD - "heavy duty" - "fix position"

- Manufactured from high quality, corrosion resistant powder coated steel for holding rods in the most secure way.
- Holds the objects on a fixed position.
- Sturdy construction guarantees the use with heavy objects.
- Clamps can be opened and closed smoothly with a 23 mm grip diameter.

| catalogue number | pack quantity |
|------------------|---------------|
| 046.05.002 | 1 piece |



BOSSEHEAD - "standard" - "swivel head"

- Manufactured from high quality, corrosion resistant chromated steel for holding rods in the most secure way.
- Featured with a swivel bosshead which provides 360° swivel of the clamped object around their axis.
- Bosshead locking feature guarantees perfect position hold of the clamped objects.
- Clamps can be opened and closed smoothly with a 25 mm grip diameter.

| catalogue number | pack quantity |
|------------------|---------------|
| 046.01.002 | 1 piece |

lab consumables & labware



TONGS - "rod jaws"

- Manufactured from high quality, corrosion resistant chromated steel for holding erlenmeyers and flasks in the most secure way.
- Soft and elastic coating holds the glassware gently and prevent possible breakage.

- PVC coated insulated jaws guarantees perfect heat insulation.

| catalogue number | pos. no | pack quantity |
|------------------|---------|---------------|
| 029.03.001 | 1 | 1 piece |
| 026.03.001 | 2 | 1 piece |

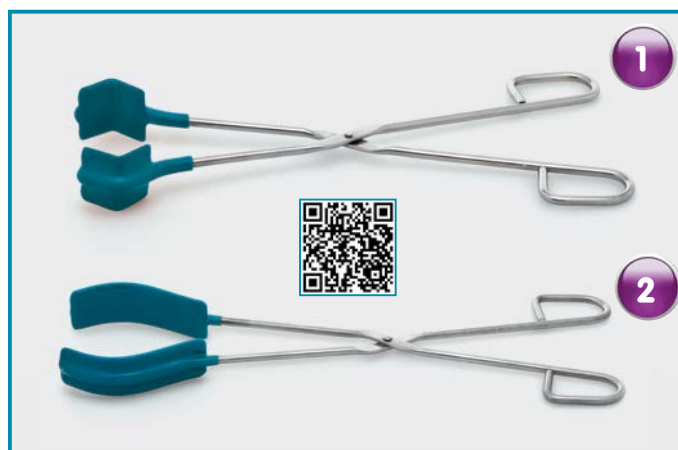

TONGS - "flat jaws"

- Manufactured from high quality, corrosion resistant chromated steel for holding erlenmeyers and flasks in the most secure way.
- Soft and elastic coating holds the glassware gently and prevent possible breakage.

- PVC coated insulated jaws guarantees perfect heat insulation.

| catalogue number | pos. no | pack quantity |
|------------------|---------|---------------|
| 029.03.002 | 1 | 1 piece |
| 026.03.002 | 2 | 1 piece |



TONGS - "for evaporating dishes"

- Manufactured from high quality, chromated steel.

- Unique design with grabbing jaws enables safe holding of dishes.

| catalogue number | total length | pack quantity |
|------------------|--------------|---------------|
| 038.05.001 | 280 mm | 1 piece |



TONGS - "for crucibles"

- Manufactured from high quality, chromated steel for holding crucibles.

- Unique design with grabbing jaws enables safe holding of crucibles.

| catalogue number | total length | pack quantity |
|------------------|--------------|---------------|
| 038.06.250 | 250 mm | 1 piece |
| 038.06.300 | 300 mm | 1 piece |
| 038.06.400 | 400 mm | 1 piece |

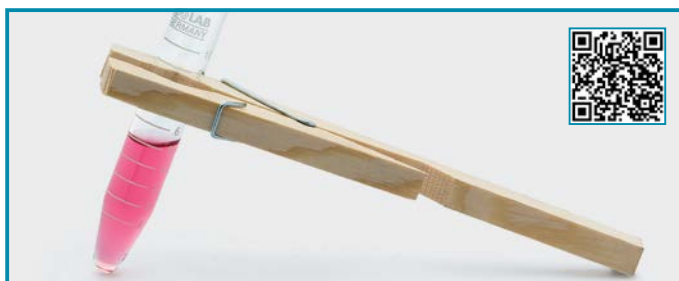

CLAMP - "for tubes" - "wood"

- Manufactured from hardened wood for holding tubes in the most secure way.

- Featured with a steel spring for tight and firm holding of the tubes.

| catalogue number | total length | pack quantity |
|------------------|--------------|---------------|
| 080.04.001 | 180 mm | 1 piece |



CLAMP - "for tubes" - "steel"

- Manufactured from chromated steel for holding tubes in the most secure way.

- Featured with a steel spring and a finger for tight and firm holding of the tubes.

| catalogue number | total length | pack quantity |
|------------------|--------------|---------------|
| 080.04.002 | 150 mm | 1 piece |



SPATULAS - "st. steel" - "macro spoon"

➤ Manufactured from AISI 304 grade stainless steel. Most commonly used spatula.

➤ Featured with a macro spoon for medium and large size particles at one end and a straight/flat spatula at the other end.

| catalogue number | total length | pack quantity |
|------------------|--------------|---------------|
| 047.01.120 | 120 mm | 1 piece |
| 047.01.150 | 150 mm | 1 piece |
| 047.01.180 | 180 mm | 1 piece |
| 047.01.210 | 210 mm | 1 piece |
| 047.01.250 | 250 mm | 1 piece |
| 047.01.300 | 300 mm | 1 piece |

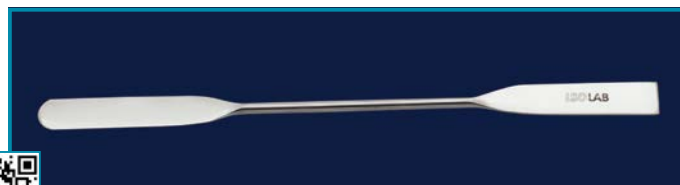

SPATULAS - "st. steel" - "double end"

➤ Manufactured from AISI 304 grade stainless steel. Suitable for transferring products from flat or sticky surfaces.

➤ Featured with a round/flat spatula at one end and a straight/flat spatula at the other end.

| catalogue number | total length | pack quantity |
|------------------|--------------|---------------|
| 047.07.130 | 130 mm | 1 piece |
| 047.07.150 | 155 mm | 1 piece |
| 047.07.185 | 180 mm | 1 piece |
| 047.07.210 | 210 mm | 1 piece |
| 047.07.250 | 255 mm | 1 piece |
| 047.07.300 | 300 mm | 1 piece |

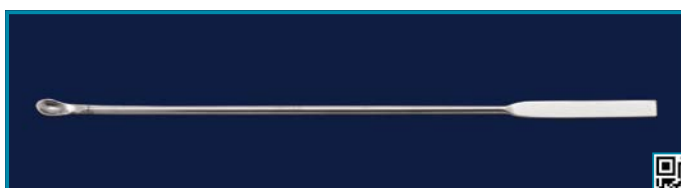

SPATULAS - "st. steel" - "micro spoon"

➤ Manufactured from AISI 304 grade stainless steel. Featured with a micro spoon for small size particles at one end and a straight/flat spatula at the other end.

| catalogue number | total length | pack quantity |
|------------------|--------------|---------------|
| 047.06.150 | 150 mm | 1 piece |
| 047.06.180 | 180 mm | 1 piece |
| 047.06.210 | 210 mm | 1 piece |

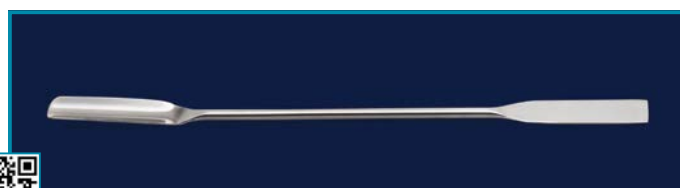

SPATULAS - "st. steel" - "round grooved"

➤ Manufactured from AISI 304 grade stainless steel. Featured with a grooved spoon at one end and a straight/flat spatula at the other end.

| catalogue number | total length | pack quantity |
|------------------|--------------|---------------|
| 047.02.150 | 150 mm | 1 piece |
| 047.02.180 | 185 mm | 1 piece |
| 047.02.210 | 210 mm | 1 piece |



SPATULAS - "st. steel" - "curved end"

➤ Manufactured from AISI 304 grade stainless steel. Featured with a curved/flat spatula at one end and a curved /flat spatula at the other end.

| catalogue number | total length | pack quantity |
|------------------|--------------|---------------|
| 047.03.150 | 150 mm | 1 piece |
| 047.03.180 | 180 mm | 1 piece |
| 047.03.210 | 210 mm | 1 piece |



SPATULAS - "st. steel" - "poly"

➤ Manufactured from AISI 304 grade stainless steel. Featured with an ellipsoidal/curved spoon at one end and a straight/flat triangular spatula at the other end.

| catalogue number | total length | pack quantity |
|------------------|--------------|---------------|
| 047.08.150 | 150 mm | 1 piece |
| 047.08.180 | 180 mm | 1 piece |
| 047.08.210 | 210 mm | 1 piece |



SPATULAS - "st. steel" - "chattaway"

➤ Manufactured from AISI 304 grade stainless steel. Suitable for transferring products from flat or sticky surfaces. Featured with a curved/flat spatula at one end and a straight/flat spatula at the other end.

| catalogue number | total length | pack quantity |
|------------------|--------------|---------------|
| 047.09.100 | 100 mm | 1 piece |
| 047.09.130 | 130 mm | 1 piece |
| 047.09.150 | 150 mm | 1 piece |
| 047.09.180 | 180 mm | 1 piece |
| 047.09.210 | 210 mm | 1 piece |



SPATULAS - "st. steel" - "flat knife"

➤ Manufactured from AISI 304 grade stainless steel with a wooden handle. Suitable for large size transferring products. Featured with a flat knife formed spatula at one end and a wooden handle at the other end.

| catalogue number | knife length | pack quantity |
|------------------|--------------|---------------|
| 047.10.075 | 75 mm | 1 piece |
| 047.10.100 | 100 mm | 1 piece |
| 047.10.150 | 150 mm | 1 piece |
| 047.10.200 | 200 mm | 1 piece |
| 047.10.300 | 300 mm | 1 piece |

lab consumables & labware

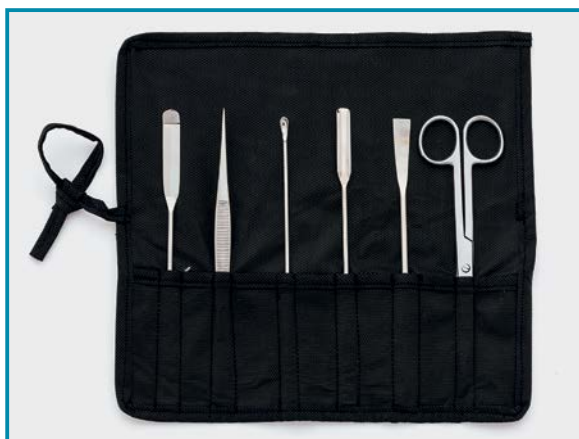

SPATULAS - "in a wallet"

➤ A practical set of 6 most common and frequently used spatulas all manufactured from high quality, chemical and corrosion resistant AISI 304 grade stainless steel .

➤ Set consists of one of each micro spoon / curved and ground/ chattaway spatula with all 180 mm length and dissecting forcep / blunt - sharp scissors with 160 mm length.

➤ All spatulas are placed into suitable holding pockets of the wallet that keeps the spatulas away from disorder and exterior effects.

| spatula set | pack quantity |
|-------------|---------------|
| 047.05.001 | 1 piece |

| empty wallet | pack quantity |
|--------------|---------------|
| 047.05.002 | 1 piece |

SCOOPS - "polypropylene" - "self standing"



➤ Manufactured from high quality polypropylene which resists to most acids, bases and many commonly used solvents.

➤ Guarantees excellent temperature resistance between -20°C to +121°C.

➤ Perfect shape and size enable efficient sampling of various powder, granulate and paste form samples.

➤ 9 volume sizes from 2 ml to 1000 ml offer a wide sampling option from smallest to largest sample volume.

➤ Due to their flat bottom construction these scoops can stand horizontal on the flat surfaces and can also be used as a weighing pan.

➤ With the help of precision formed sharp edge they offer best performance while picking up samples even from wet surfaces.



Featured with easy to grip handles for comfortable use. Approximate volume values are printed on the handles.

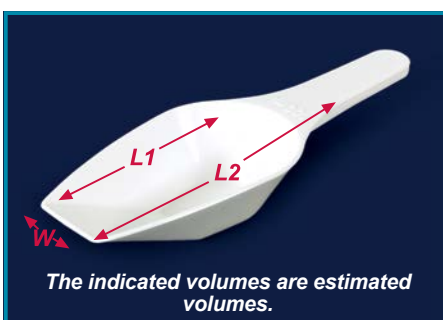

| white scoops | blue scoops | volume | L1 | L2 | W | pack quantity |
|--------------|-------------|---------|--------|--------|-------|---------------|
| 037.30.002W | 037.30.002B | 2 ml | 31 mm | 62 mm | 10 mm | 1 piece |
| 037.30.005W | 037.30.005B | 5 ml | 42 mm | 82 mm | 13 mm | 1 piece |
| 037.30.010W | 037.30.010B | 10 ml | 56 mm | 96 mm | 16 mm | 1 piece |
| 037.30.025W | 037.30.025B | 25 ml | 74 mm | 128 mm | 21 mm | 1 piece |
| 037.30.050W | 037.30.050B | 50 ml | 92 mm | 164 mm | 27 mm | 1 piece |
| 037.30.100W | 037.30.100B | 100 ml | 118 mm | 203 mm | 34 mm | 1 piece |
| 037.30.250W | 037.30.250B | 250 ml | 153 mm | 263 mm | 44 mm | 1 piece |
| 037.30.500W | 037.30.500B | 500 ml | 195 mm | 317 mm | 57 mm | 1 piece |
| 037.30.901W | 037.30.901B | 1000 ml | 250 mm | 390 mm | 72 mm | 1 piece |



Due to their flat bottom construction these scoops can stand horizontal on a flat surface and can also be used as a weighing pan.



Same size scoops are easily stackable for reducing storage space. Different color options offer easy visual sorting.



With the help of precision formed sharp edge they offer best performance while picking up samples even from wet surfaces.

SCOOPS - "polystyrene" - "self standing" - "with & without lid"



► Manufactured from high quality polystyrene which resists to most acids, bases and many commonly used solvents. Guarantees temperature resistance between -10°C to +70°C.

► Perfect shape and size enable efficient sampling of various powder, granulate and paste form samples.

► 6 volume sizes from 25 ml to 500 ml offer an wide sampling option from smallest to largest sample volume.

► Due to their flat bottom and slightly inclined handle construction these scoops stand horizontal on the flat surfaces and can also be used as weighing pans.

► Easy to grip and long handle increases the distance between the hand and the sample to reduce cross contamination risks and also offers comfortable use.

► Approximate volume values are printed on the handles.

► **Alternative scoops:** ► **Non-sterile scoops** ► **Gamma sterile scoops**

► Some scoops are manufactured at aseptic production halls and then send to gamma sterilisation. Such informations about number of production, lot number, expiry dates etc. are indicated on the packaging.

► Sterile scoops are manufactured as single use. They minimize the costs by using sterile barrier containers in sample collection process.

► Sterile scoops are featured with a press-on, transparent lid which enable easy identification of sample and protects the sample from dust, moisture and other environmental effects.

► The transparent lid should be closed immediately after the sampling procedure to secure a sterile and contamination-free sample. This is featured with a frosted write on area.

| sterile scoops | non-sterile blue scoops | gamma sterile white scoops with lid | volume | L1 | L2 | W | pack quantity |
|----------------|-------------------------|-------------------------------------|--------|--------|--------|-------|---------------|
| 037.35.025W | 037.35.025B | 037.36.025W | 25 ml | 57 mm | 137 mm | 30 mm | 1 piece |
| 037.35.050W | 037.35.050B | 037.36.050W | 50 ml | 68 mm | 158 mm | 33 mm | 1 piece |
| 037.35.100W | 037.35.100B | 037.36.100W | 100 ml | 96 mm | 200 mm | 38 mm | 1 piece |
| 037.35.150W | 037.35.150B | 037.36.150W | 150 ml | 107 mm | 215 mm | 41 mm | 1 piece |
| 037.35.250W | 037.35.250B | 037.36.250W | 250 ml | 127 mm | 243 mm | 50 mm | 1 piece |
| 037.35.500W | 037.35.500B | 037.36.500W | 500 ml | 162 mm | 292 mm | 65 mm | 1 piece |



Precision formed sharp edge offers best performance while picking up samples even from wet surfaces.



Flat bottom and slightly inclined handle construction offer horizontal stand on the flat surfaces.



Easy to use: Detach the lid → Take the sample → Press-on the lid



Sterile scoops are featured with a press-on, transparent lid.

Non-sterile scoops are supplied without the lid.

SCOOPS - "stainless steel"



- Manufactured from high quality, AISI 304 stainless steel.
- Suitable for spooning medium and large size products. Featured with a round formed spoon at one end and a steel handle at the other end.
- Robust and seamless construction guarantees long life cycle. Smooth polished surfaces provide easy cleaning.

| catalogue number | scoop (∅) W | scoop L1 | handle L2 | pack quantity |
|------------------|-------------|----------|-----------|---------------|
| 037.08.050 | 50 mm | 96 mm | 92 mm | 1 piece |
| 037.08.075 | 75 mm | 145 mm | 100 mm | 1 piece |
| 037.08.100 | 100 mm | 203 mm | 102 mm | 1 piece |
| 037.08.120 | 120 mm | 230 mm | 105 mm | 1 piece |

SCOOP & SPOON - "stainless steel"

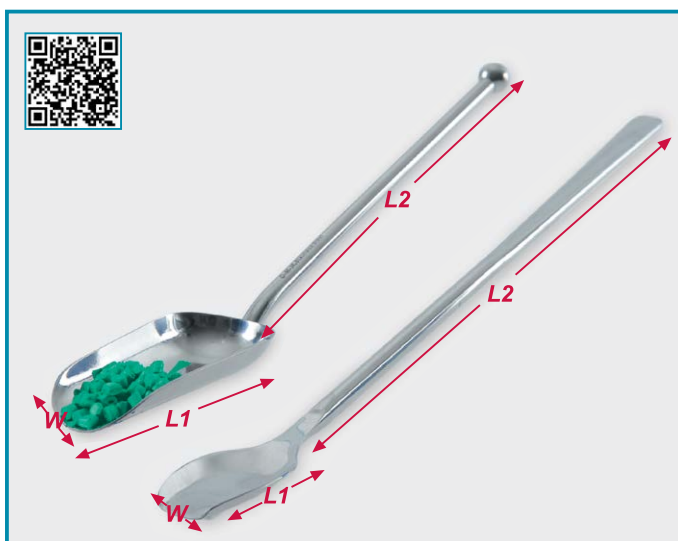

- Manufactured from high quality, chemical and corrosion resistant AISI 304 grade stainless steel.

- Suitable for spooning small to medium size products. Featured with a round formed spoon at one end and a handle at the other end.

- Robust and seamless construction guarantees long life cycle.

- Smooth polished surfaces provide fast and easy cleaning.

| scoop cat. no. | scoop (∅) W | scoop L1 | handle L2 | pack quantity |
|----------------|-------------|----------|-----------|---------------|
| 047.18.002 | 21 mm | 63 mm | 140 mm | 1 piece |

| spoon cat. no. | scoop (∅) W | scoop L1 | handle L2 | pack quantity |
|----------------|-------------|----------|-----------|---------------|
| 047.18.001 | 11 mm | 30 mm | 160 mm | 1 piece |



SCOOPS - "polystyrene" - "sterile"

- Manufactured from high quality polystyrene as a single use.
- Resists to most acids, bases and many commonly used solvents. Guaranteed temperature resistance between -10°C to +70°C.
- Sterile spoons are "DNase, RNase and pyrogen-free" since sterilised by gamma irradiation after production step. Individually single packed with lot number, production date and expiry date printed on the package.
- Approximate volume values are printed on the handles.
- Perfect shape and size enable efficient sampling of various powder, granulate and paste form samples.
- Easy to grip and long handle increases the distance between the hand and the sample to reduce cross contamination risks.

| catalogue number | spoon volume | scoop (∅) W | spoon L1 | handle L2 | pack quantity |
|------------------|--------------|-------------|----------|-----------|---------------|
| 037.36.002 | 2,5 ml | 22 mm | 36 mm | 54 mm | 1 piece |
| 037.36.010 | 10 ml | 31 mm | 56 mm | 110 mm | 1 piece |

SPATULAS - "polypropylene" - "macro spoon"



Flexible body form offers best sampling and collection options even for wet pastes.



➤ Manufactured from high quality flexible polypropylene.

➤ Most commonly used spatula. Featured with a macro spoon form for small, medium and large size particles at one end and a straight/flat spatula form at the other end.

➤ Robust and seamless construction guarantees long life cycle. Smooth polished surfaces provide fast and easy cleaning.

➤ Also offers practical solutions for mixing and stirring solutions manually by hand.

➤ Flat end has 35 degree sharp edges for easy removal of the residues on flat surfaces.

➤ Flexible body form offers best sampling and collecting.

➤ **Alternative 2 spatulas:** ➤ **Non-sterile spatulas**
➤ **Gamma sterile spatulas**

➤ Gamma sterilised sterile spatulas carry such informations as lot number, production and expiry dates etc on the packing.

| total length | non-sterile spatulas | gamma sterile spatulas | pack quantity |
|--------------|----------------------|------------------------|---------------|
| 150 mm | 047.32.150 | 047.33.150 | 1 piece |
| 180 mm | 047.32.180 | 047.33.180 | 1 piece |
| 210 mm | 047.32.210 | 047.33.210 | 1 piece |



Featured with a macro spoon form for small, medium and large size particles

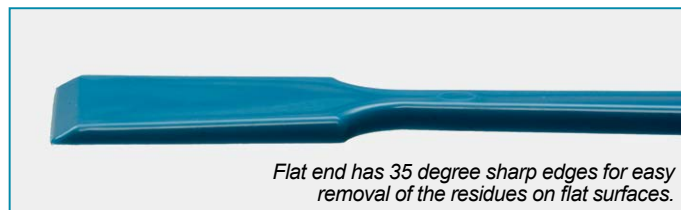

Flat end has 35 degree sharp edges for easy removal of the residues on flat surfaces.

SPATULAS - "sterile" - "with lid" - "polystyrene"

➤ Manufactured from high quality polystyrene which resists to most acids, bases and many commonly used solvents. Guarantees temperature resistance between -10°C to +70°C.

➤ Gamma sterile spatulas are manufactured as single use. They eliminate the need of separate sterile bags or containers in sample collection.

➤ Perfect shape and size enables efficient sampling of various powder, granulate and pasty form samples.

➤ Sharp blade penetrates directly into paper or plastic bags for optimum and quick sampling process.

➤ Easy to grip and long handle increases the distance between the hand and the sample to reduce cross contamination risks.

➤ Approximate volume values are printed on scoop handles.

➤ Sterile spatulas are featured with a transparent lid which protects the samples from dust, moisture and other effects.

➤ The transparent lid should be closed immediately after the sampling to secure a sterile and contamination-free sample.

➤ Lid is featured with a frosted write on area for practical use.

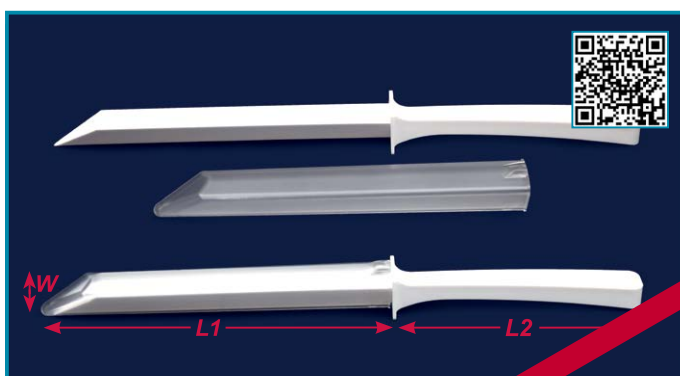

Sharp blade penetrates directly into paper or plastic bags for optimum and quick sampling process.

Spatulas are featured with a lid which protects the samples from dust, moisture and other effects.



| catalogue number | spatula (Ø) W | spatula L1 | handle L2 | pack quantity |
|------------------|---------------|------------|-----------|---------------|
| 037.36.001 | 13 mm | 150 mm | 110 mm | 1 piece |

lab consumables & labware



FORCEPS - "general use"

➤ Manufactured from AISI 304 grade stainless steel. Most commonly used forceps. Featured with a blunt point tip without jaw.

| catalogue number | total length | pack quantity |
|------------------|--------------|---------------|
| 048.01.105 | 105 mm | 1 piece |
| 048.01.115 | 115 mm | 1 piece |
| 048.01.130 | 130 mm | 1 piece |
| 048.01.145 | 145 mm | 1 piece |
| 048.01.160 | 160 mm | 1 piece |
| 048.01.200 | 200 mm | 1 piece |
| 048.01.250 | 250 mm | 1 piece |
| 048.01.300 | 300 mm | 1 piece |

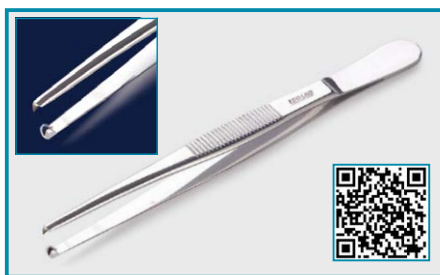

FORCEPS - "with tooth"

➤ Manufactured from AISI 304 grade stainless steel. Featured with a blunt point tip with a 1:2 array jaws for much effective and forced grasping.

| catalogue number | total length | pack quantity |
|------------------|--------------|---------------|
| 048.02.115 | 115 mm | 1 piece |
| 048.02.130 | 130 mm | 1 piece |
| 048.02.145 | 145 mm | 1 piece |
| 048.02.160 | 160 mm | 1 piece |

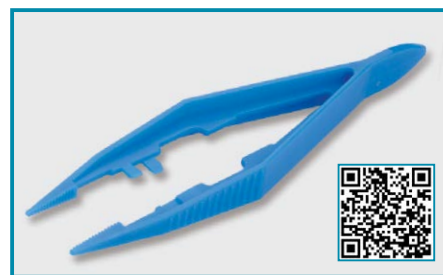

FORCEPS - "non-sterile"

➤ Manufactured from high quality, chemical and corrosion resistant ABS. Fine sharp tips and straight body form offer multiple advantages.



| catalogue number | total length | pack quantity |
|------------------|--------------|---------------|
| 048.10.110 | 110 mm | 10 pieces |



FORCEPS - "general use" - "sterile"

➤ Manufactured under germ-free gamma sterile conditions with extreme sterility control from ABS. Certified as "DNase, RNase and pyrogen-free since sterilised by gamma irradiation after production step.

➤ Individually single packed with lot number, production date and expiry date printed on the package.

| catalogue number | total length | pack quantity |
|------------------|--------------|---------------|
| 048.11.110 | 110 mm | 1 piece |



FORCEPS - "dissecting use"

➤ Manufactured from AISI 304 grade stainless steel. Most commonly used forceps for dissecting.

➤ Featured either with an straight fine sharp point tip or with curved inclined fine sharp point tip.

| forceps with straight tip | forceps with curved tip | total length | pack quantity |
|---------------------------|-------------------------|--------------|---------------|
| 048.07.105 | 048.08.105 | 105 mm | 1 piece |
| 048.07.115 | 048.08.115 | 115 mm | 1 piece |
| 048.07.130 | 048.08.130 | 130 mm | 1 piece |
| 048.07.150 | | 150 mm | 1 piece |
| 048.07.160 | | 160 mm | 1 piece |
| 048.07.200 | | 200 mm | 1 piece |



FORCEPS - "for cover glasses"

➤ Manufactured from AISI 304 grade stainless steel. Most commonly used forceps for handling cover glasses.

➤ Featured either with a flat inclined tip or with a flat straight tip.

| forceps with inclined tip | forceps with straight tip | total length | pack quantity |
|---------------------------|---------------------------|--------------|---------------|
| 048.03.001 | 048.03.002 | 105 mm | 1 piece |



SCISSORS - "general use" - "sharp tip" & "blunt tip" & "blunt/sharp tip"

➤ Manufactured from AISI 304 grade stainless steel with straight form. Most commonly used scissors.

➤ Robust and seamless construction guarantees long life cycle.

| total length | scissors sharp tip | scissors blunt tip | scissors blunt / sharp tip | pack quantity |
|--------------|--------------------|--------------------|----------------------------|---------------|
| 130 mm | 048.22.130 | 048.23.130 | 048.24.130 | 1 piece |
| 160 mm | 048.22.160 | 048.23.160 | 048.24.160 | 1 piece |



SCISSORS - "dissecting use"

➤ Manufactured from AISI 304 grade stainless steel. Most commonly used scissors for dissecting.

➤ Featured either with a straight and fine sharp point tip or curved and fine sharp point tip.

| scissor straight tip | scissor curved tip | total length | pack quantity |
|----------------------|--------------------|--------------|---------------|
| 048.25.130 | 048.26.130 | 130 mm | 1 piece |



SCISSORS - "general use"

➤ Scissor part manufactured from high quality steel. Commonly used scissors for general applications. Featured with a straight and fine sharp point tips.

| catalogue number | total length | pack quantity |
|------------------|--------------|---------------|
| 048.30.130 | 130 mm | 1 piece |
| 048.30.160 | 160 mm | 1 piece |
| 048.30.200 | 200 mm | 1 piece |



SCISSORS - "heavy duty"

➤ Scissor part manufactured from high quality steel. Most commonly used scissor for cutting all materials even thin layer of metal sheets.

➤ Spring supported ergonomic plastic handle with safety lock offers easy, fast and safe use.

| catalogue number | total length | pack quantity |
|------------------|--------------|---------------|
| 048.31.001 | 185 mm | 1 piece |



CUTTERS

➤ Can be used as a cutter, as a safety knife suitable for detailed precise cutting. Both models are featured with both a break-off device.

➤ Large cutter is also featured with an auto-lock knob as additional safety.

➤ Light weight and ergonomic handle offers excellent grip option.

| catalogue number | blade length | blade width | pack quantity |
|------------------|--------------|-------------|---------------|
| 048.06.001 | 80 mm | 9 mm | 1 piece |
| 048.06.002 | 100 mm | 18 mm | 1 piece |

lab consumables & labware

SCALPEL - "with safety cover"

- Single packed sterile scalpel featured with highest grade stainless steel cutting blade.
- Handle is manufactured from polypropylene with a soft grip option.
- The safety cover closes the blade part securely and prevents the unexpected cut risks.

| catalogue number | total length | blade length | pack quantity |
|------------------|--------------|--------------|---------------|
| 048.50.003 | 140 mm | 40 mm | 1 piece |

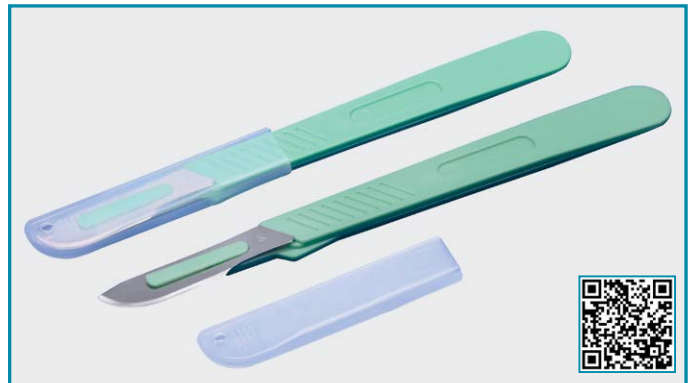

SCALPEL HANDLES

- Manufactured from stainless steel with approximate length of 130 mm.
- Handle no: 1 carries blades size from 10 to 18. Handle no: 2 carries blade size from 18 to 24.
- Grids at the front part guarantees perfect control during usage.

| catalogue number | handle no | total length | pack quantity |
|------------------|-----------|--------------|---------------|
| 048.50.001 | 1 | 130 mm | 1 piece |
| 048.50.002 | 2 | 130 mm | 1 piece |

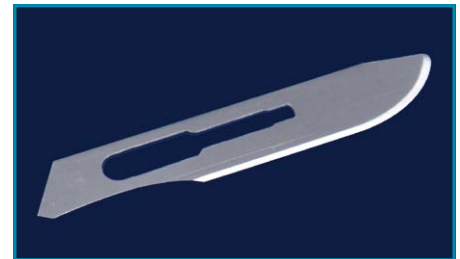
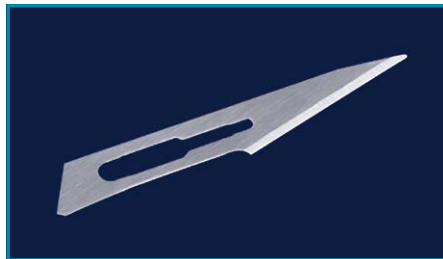
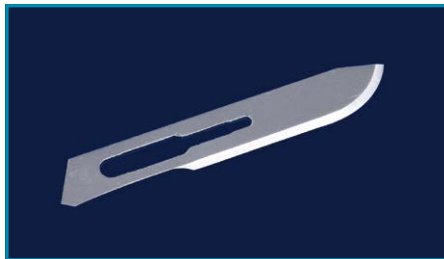

SCALPEL BLADE - "no:10"

- Manufactured from carbon steel and sterilised with gamma radiation.
- Suitable to be used with scalpel handle no: 1.

| catalogue number | for handle | blade length | pack quantity |
|------------------|------------|--------------|---------------|
| 048.51.010 | no:1 | 25 mm | 100 pieces |

SCALPEL BLADE - "no:11"

- Manufactured from carbon steel and sterilised with gamma radiation.
- Suitable to be used with scalpel handle no: 1.

| catalogue number | for handle | blade length | pack quantity |
|------------------|------------|--------------|---------------|
| 048.51.011 | no:1 | 20 mm | 100 pieces |

SCALPEL BLADE - "no:21"

- Manufactured from carbon steel and sterilised with gamma radiation.
- Suitable to be used with scalpel handle no: 2.

| catalogue number | for handle | blade length | pack quantity |
|------------------|------------|--------------|---------------|
| 048.51.021 | no:2 | 35 mm | 100 pieces |



DISSECTING NEEDLES

- Needle parts are manufactured from stainless steel with sharp ends.
- Supplied as a set consisting of 3 needles:

- dissecting needle, **straight**
- dissecting needle, **bent**
- dissecting needle, **lanceolated**

| catalogue number | pack quantity |
|------------------|---------------|
| 052.30.001 | 1 set |



BUNSEN BURNER "standard type"

- Most common used Bunsen burner with flame adjustment.
- Can be used with all gases such as neutral gas, butane gas and coal gas.
- Offers practical control of flame from very slow heating to rapid boiling with an adjustable air and gas regulation ring.
- Precise flame adjustment is guaranteed by a screw driven gas control knob.

| catalogue number | pack quantity |
|------------------|---------------|
| 050.01.001 | 1 piece |



BUNSEN BURNER "advanced type"

- Preferably used if higher heating capacity is required.
- Can be used with all gases such as neutral gas, butane gas and coal gas.
- Offers practical control of flame from very slow heating to rapid boiling with an adjustable air and gas regulation ring.
- Precise flame adjustment is guaranteed by a screw driven gas control knob.

| catalogue number | pack quantity |
|------------------|---------------|
| 050.01.002 | 1 piece |



BUNSEN BURNER "meker type"

- For very high heating heating up to 1700°C is required.
- Can be used with all gases such as neutral gas, butane gas and coal gas.
- Offers practical control of flame from very slow heating to rapid boiling with an adjustable air and gas regulation ring.
- Precise flame adjustment is guaranteed by a screw driven gas control knob.

| catalogue number | pack quantity |
|------------------|---------------|
| 050.01.003 | 1 piece |



BUNSEN BURNER STABILIZER

- There is always a tilt over risk for Bunsen burners.
- Bunsen burner stabilizer provides a very stable and robust additional base and holds the attached Bunsen burner firmly avoiding above mentioned risk.
- The nest perfectly fits to the bases of Bunsen burners with catalogue no: 050.01.002 and 050.01.003.
- First insert the Bunsen burner into the stabilizer nest. Then stabilize the Bunsen burner by fixing the provided screw tightly.

| catalogue number | pack quantity |
|------------------|---------------|
| 050.09.001 | 1 piece |



HOSES - "for bunsen burners"

- Manufactured from extra thick walled rubber. Specially designed to be used with Bunsen burners.
- Reinforced ends fits perfect to the Bunsen burner at one side and the gas tap at the other side assuring gas leakage free connection.

| catalogue number | pack quantity |
|------------------|---------------|
| 050.08.075 | 1 piece |
| 050.08.100 | 1 piece |

ISOLAB[®]
chemicals



Committed to
Quality

ISOLAB chemicals is a registered trademark of ISOLAB Laborgeräte GmbH



DESICCATORS "glass" - "non-vacuum"

- Manufactured thick, robust and heat resistant, durable borosilicate glass without vacuum stopcock.
- Excellent smooth grinded body and lid flanges guarantee airtight closure. Supplied with a porcelain perforated desiccator plate.

| catalogue number | desiccator diameter | pack quantity |
|------------------|---------------------|---------------|
| 039.01.200 | 200 mm | 1 piece |
| 039.01.250 | 250 mm | 1 piece |
| 039.01.300 | 300 mm | 1 piece |

| spare lid for non-vacuum desc. | lid diameter | pack quantity |
|--------------------------------|--------------|---------------|
| 039.06.200 | 200 mm | 1 piece |
| 039.06.250 | 250 mm | 1 piece |
| 039.06.300 | 300 mm | 1 piece |



DESICCATORS "glass" - "vacuum"

- Manufactured from borosilicate glass. Featured with a 2-way high vacuum stopcock enabling consistent and uniform vacuum draw and release.
- Excellent smooth grinded body and lid flanges guarantee airtight closure. Supplied with a porcelain perforated desiccator plate.

| catalogue number | desiccator diameter | pack quantity |
|------------------|---------------------|---------------|
| 039.02.200 | 200 mm | 1 piece |
| 039.02.250 | 250 mm | 1 piece |
| 039.02.300 | 300 mm | 1 piece |

| spare lid for vacuum desc. | lid diameter | pack quantity |
|----------------------------|--------------|---------------|
| 039.07.200 | 200 mm | 1 piece |
| 039.07.250 | 250 mm | 1 piece |
| 039.07.300 | 300 mm | 1 piece |



DESICCATORS "P.P & P.C" - "vacuum"

- Manufactured P.P base with transparent P.C cover. Featured with a 3-way high vacuum stopcock enabling consistent and uniform vacuum draw and release.
- Silicone gasket between body and the lid ensures airtight closure. Supplied with a polypropylene perforated desiccator plate.

| catalogue number | desiccator diameter | pack quantity |
|------------------|---------------------|---------------|
| 039.12.200 | 200 mm | 1 piece |
| 039.12.250 | 250 mm | 1 piece |
| 039.12.300 | 300 mm | 1 piece |

| spare porcelain desiccator plates | lid diameter | pack quantity |
|-----------------------------------|--------------|---------------|
| 039.05.200 | 190 mm | 1 piece |
| 039.05.250 | 235 mm | 1 piece |
| 039.05.300 | 300 mm | 1 piece |

SILICA - GEL DESICCANT BEADS

- Silica-Gel beads are moisture absorbing self - indicating drying agents.
- Perfect substitute of classical desiccator moisture absorbents.
- Beads has a grain size variable from 1 to 3 mm. They are free from any heavy and environmentally compatible.
- Original orange color gradually turns to white as the gel absorbs moisture.
- Color change offers monitoring of the saturation level.
- Silica-Gel beads can be regenerated when heated at a temperature of maximum 120°C.
- The color turns back to original orange color.
- Packed as 1 kg in a sealed P.P bottle in order to prevent preabsorption of moisture.

| catalogue number | packing specification |
|------------------|-----------------------|
| 039.16.001 | 1 kg in P.P bottle |





MORTARS - "agate"

- Manufactured from high quality, natural agate stone with standard depth.
- Supplied with a pestle with relevant size to agate mortar.

| catalogue number | volume | ext. dia | height | pack quantity |
|------------------|--------|----------|--------|---------------|
| 038.07.050 | 9 ml | 50 mm | 25 mm | 1 piece |
| 038.07.075 | 22 ml | 75 mm | 30 mm | 1 piece |
| 038.07.100 | 50 ml | 100 mm | 40 mm | 1 piece |
| 038.07.125 | 120 ml | 125 mm | 45 mm | 1 piece |
| 038.07.150 | 270 ml | 150 mm | 55 mm | 1 piece |



MORTARS - "deep form"

- Manufactured from high quality, natural agate stone with extra depth compared to standard deep mortars.
- Supplied with a pestle with relevant size to agate mortar.

| catalogue number | volume | ext. dia | height | pack quantity |
|------------------|--------|----------|--------|---------------|
| 038.09.060 | 25 ml | 60 mm | 35 mm | 1 piece |
| 038.09.070 | 35 ml | 70 mm | 40 mm | 1 piece |
| 038.09.080 | 60 ml | 80 mm | 45 mm | 1 piece |
| 038.09.100 | 100 ml | 100 mm | 55 mm | 1 piece |
| 038.09.120 | 165 ml | 120 mm | 60 mm | 1 piece |



MORTARS - "black agate"

- Manufactured from high quality, natural black agate stone with standard depth.
- Supplied with a pestle with relevant size to agate mortar.

| catalogue number | volume | ext. dia | height | pack quantity |
|------------------|--------|----------|--------|---------------|
| 038.18.065 | 25 ml | 65 mm | 30 mm | 1 piece |
| 038.18.085 | 70 ml | 85 mm | 35 mm | 1 piece |
| 038.18.110 | 140 ml | 115 mm | 45 mm | 1 piece |
| 038.18.125 | 210 ml | 125 mm | 50 mm | 1 piece |
| 038.18.150 | 350 ml | 150 mm | 55 mm | 1 piece |



MORTARS - "alsint"

- Manufactured from extremely chemical resistant pure 99,7 % aluminium oxide (alsint).
- Recommended for use absolute contamination free crushing.
- Supplied with a pestle with relevant size to alsint mortar.

| catalogue number | volume | ext. dia | height | pack quantity |
|------------------|--------|----------|--------|---------------|
| 038.08.050 | 7 ml | 50 mm | 26 mm | 1 piece |
| 038.08.075 | 30 ml | 75 mm | 40 mm | 1 piece |
| 038.08.100 | 80 ml | 100 mm | 48 mm | 1 piece |
| 038.08.125 | 120 ml | 125 mm | 70 mm | 1 piece |
| 038.08.150 | 150 ml | 150 mm | 75 mm | 1 piece |



MORTARS - "porcelain"

- Manufactured from high quality, glazed porcelain according to DIN 12906 standard.
- Grinding chamber made from unglazed porcelain provides perfect hold of the samples during crushing without splattering.
- **Supplied without pestle. Please select the appropriate pestle.**

| catalogue number | volume | ext. dia | height | pack quantity |
|------------------|---------|----------|--------|---------------|
| 038.02.065 | 70 ml | 80 mm | 40 mm | 1 piece |
| 038.02.090 | 170 ml | 105 mm | 55 mm | 1 piece |
| 038.02.130 | 400 ml | 150 mm | 70 mm | 1 piece |
| 038.02.150 | 700 ml | 175 mm | 70 mm | 1 piece |
| 038.02.180 | 1000 ml | 207 mm | 80 mm | 1 piece |



PESTLES - "porcelain"

- Manufactured from high quality, glazed porcelain according to DIN 12906 standard.
- Grinding head made from unglazed porcelain for crushing without splattering.

| catalogue number | head diameter | total length | pack quantity |
|------------------|---------------|--------------|---------------|
| 038.03.115 | 24 mm | 115 mm | 1 piece |
| 038.03.135 | 30 mm | 135 mm | 1 piece |
| 038.03.150 | 36 mm | 150 mm | 1 piece |
| 038.03.175 | 42 mm | 175 mm | 1 piece |
| 038.03.210 | 55 mm | 210 mm | 1 piece |



EVAPORATING DISHES "porcelain" - "flat base"

➤ Manufactured from high quality, glazed porcelain according to DIN 12903 standard.

| catalogue number | volume | ext. dia | height | pack quantity |
|------------------|--------|----------|--------|---------------|
| 038.11.060 | 20 ml | 63 mm | 13 mm | 6 pieces |
| 038.11.080 | 40 ml | 80 mm | 20 mm | 6 pieces |
| 038.11.100 | 80 ml | 110 mm | 25 mm | 6 pieces |
| 038.11.125 | 270 ml | 125 mm | 27 mm | 6 pieces |
| 038.11.160 | 450 ml | 160 mm | 35 mm | 6 pieces |



EVAPORATING DISHES "porcelain" - "round base"

➤ Manufactured from high quality, glazed porcelain according to DIN 12903 standard.

| catalogue number | volume | ext. dia | height | pack quantity |
|------------------|--------|----------|--------|---------------|
| 038.12.060 | 40 ml | 60 mm | 25 mm | 6 pieces |
| 038.12.080 | 75 ml | 80 mm | 30 mm | 6 pieces |
| 038.12.100 | 180 ml | 100 mm | 45 mm | 6 pieces |
| 038.12.125 | 310 ml | 125 mm | 48 mm | 6 pieces |
| 038.12.160 | 640 ml | 160 mm | 58 mm | 6 pieces |



CRYSTALLIZATION DISHES "glass" - "flat base"

➤ Manufactured from heat resistant, durable borosilicate glass according to DIN 12338.

| catalogue number | volume | ext. dia | height | pack quantity |
|------------------|--------|----------|--------|---------------|
| 049.05.060 | 85 ml | 60 mm | 35 mm | 1 piece |
| 049.05.100 | 110 ml | 70 mm | 40 mm | 1 piece |
| 049.05.150 | 160 ml | 80 mm | 45 mm | 1 piece |
| 049.05.300 | 280 ml | 95 mm | 55 mm | 1 piece |
| 049.05.900 | 860 ml | 140 mm | 75 mm | 1 piece |



EVAPORATING DISHES "st. steel" - "round base"

➤ Manufactured from high quality, chemical and corrosion resistant AISI 304 grade stainless steel.

| catalogue number | volume | ext. dia | height | pack quantity |
|------------------|--------|----------|--------|---------------|
| 038.14.060 | 50 ml | 60 mm | 30 mm | 1 piece |
| 038.14.080 | 125 ml | 80 mm | 40 mm | 1 piece |
| 038.14.100 | 250 ml | 100 mm | 55 mm | 1 piece |



CRYSTALLIZATION DISHES "st. steel" - "flat base"

➤ Manufactured from high quality, chemical and corrosion resistant AISI 304 grade stainless steel.

| catalogue number | volume | ext. dia | height | pack quantity |
|------------------|--------|----------|--------|---------------|
| 049.08.070 | 100 ml | 70 mm | 35 mm | 1 piece |
| 049.08.085 | 150 ml | 85 mm | 45 mm | 1 piece |
| 049.08.110 | 400 ml | 110 mm | 55 mm | 1 piece |



CRUCIBLES "st. steel" - "medium form"

➤ Manufactured from high quality, chemical and corrosion resistant AISI 304 grade stainless steel.

| catalogue number | external diameter | height | pack quantity |
|------------------|-------------------|--------|---------------|
| 038.13.S35 | 44 mm | 35 mm | 1 piece |
| 038.13.S45 | 51 mm | 45 mm | 1 piece |
| 038.13.S50 | 63 mm | 50 mm | 1 piece |



COMBUSTION BOATS - "porcelain"

➤ Manufactured from high quality, glazed porcelain.

➤ In order to prevent breakage controlled cooling and preventing use with direct flame is recommended.

| catalogue number | dimensions | height | pack quantity |
|------------------|------------|--------|---------------|
| 038.17.001 | 88 x 12 mm | 10 mm | 10 pieces |



CRUCIBLES - "porcelain"

► Manufactured from high quality, glazed porcelain according to DIN 12904 standard.

► In order to prevent breakage controlled cooling and preventing use with direct flame is recommended.

► Supplied without lid. Please select the appropriate size from lid options.



| catalogue number | external diameter | height | pack quantity |
|------------------|-------------------|--------|---------------|
| 038.14.L30 | 30 mm | 18 mm | 6 pieces |
| 038.14.L35 | 35 mm | 23 mm | 6 pieces |
| 038.14.L40 | 40 mm | 25 mm | 6 pieces |
| 038.14.L45 | 45 mm | 29 mm | 6 pieces |
| 038.14.L50 | 50 mm | 32 mm | 6 pieces |
| 038.14.L60 | 60 mm | 38 mm | 6 pieces |
| 038.14.L70 | 70 mm | 48 mm | 6 pieces |

| catalogue number | external diameter | height | pack quantity |
|------------------|-------------------|--------|---------------|
| 038.14.M35 | 35 mm | 28 mm | 6 pieces |
| 038.14.M40 | 40 mm | 32 mm | 6 pieces |
| 038.14.M45 | 45 mm | 36 mm | 6 pieces |
| 038.14.M50 | 50 mm | 40 mm | 6 pieces |
| 038.14.M60 | 60 mm | 50 mm | 6 pieces |
| 038.14.M70 | 70 mm | 60 mm | 6 pieces |
| 038.14.M82 | 82 mm | 65 mm | 6 pieces |

| catalogue number | external diameter | height | pack quantity |
|------------------|-------------------|--------|---------------|
| 038.14.H30 | 30 mm | 38 mm | 6 pieces |
| 038.14.H35 | 35 mm | 44 mm | 6 pieces |
| 038.14.H40 | 40 mm | 49 mm | 6 pieces |
| 038.14.H46 | 46 mm | 58 mm | 6 pieces |
| 038.14.H51 | 51 mm | 65 mm | 6 pieces |
| 038.14.H60 | 60 mm | 79 mm | 6 pieces |

CRUCIBLE LIDS

► Manufactured from high quality, glazed porcelain according to DIN 12904 standard.



| catalogue number | inner diameter | external diameter | pack quantity |
|------------------|----------------|-------------------|---------------|
| 038.19.035 | 33 mm | 37 mm | 6 pieces |
| 038.19.043 | 42 mm | 46 mm | 6 pieces |
| 038.19.046 | 44 mm | 49 mm | 6 pieces |
| 038.19.052 | 46 mm | 54 mm | 6 pieces |
| 038.19.060 | 57 mm | 62 mm | 6 pieces |
| 038.19.068 | 62 mm | 69 mm | 6 pieces |

CRUCIBLES
"alsint" - "wide & tall form"

► Manufactured from extremely chemical resistant pure 99,7 % aluminium oxide (alsint) resistant to 1700°C.

► In order to prevent breakage controlled cooling and preventing use with direct flame is recommended.

INCINERATING DISHES
"porcelain" - "cylindrical"

► Manufactured from high quality, glazed porcelain.

| catalogue number | internal diameter | height | pack quantity |
|------------------|-------------------|--------|---------------|
| 038.21.040 | 40 mm | 21 mm | 1 piece |
| 038.21.050 | 50 mm | 25 mm | 1 piece |
| 038.21.060 | 60 mm | 31 mm | 1 piece |

INCINERATING DISHES
"porcelain" - "rectangular"

► Manufactured from high quality, glazed porcelain.

| catalogue number | dimensions | height | pack quantity |
|------------------|-------------|--------|---------------|
| 038.20.025 | 50 x 25 mm | 10 mm | 1 piece |
| 038.20.046 | 70 x 46 mm | 13 mm | 1 piece |
| 038.20.055 | 100 x 55 mm | 16 mm | 1 piece |

| catalogue number | external diameter | height | pack quantity |
|------------------|-------------------|--------|---------------|
| 038.13.A30 | 30 mm | 24 mm | 1 piece |
| 038.13.A41 | 41 mm | 37 mm | 1 piece |
| 038.13.A48 | 48 mm | 41 mm | 1 piece |
| 038.13.A54 | 54 mm | 50 mm | 1 piece |
| 038.13.A60 | 60 mm | 50 mm | 1 piece |
| 038.13.A66 | 66 mm | 56 mm | 1 piece |



TUBINGS - "rubber" "standard type"

- Manufactured from natural rubber with standard thickness of durometer 45 A.
- Guarantees excellent chemical and temperature resistance between -25°C to +70°C.

| catalogue number | int. / ext. diameter | wall thickness | pack quantity |
|------------------|----------------------|----------------|---------------|
| 052.10.001 | 5/8 mm | 1,5 mm | 1 meter |
| 052.10.002 | 5/9 mm | 2,0 mm | 1 meter |
| 052.10.003 | 6/9 mm | 1,5 mm | 1 meter |
| 052.10.004 | 6/10 mm | 2,0 mm | 1 meter |
| 052.10.005 | 7/11 mm | 2,0 mm | 1 meter |
| 052.10.006 | 8/12 mm | 2,0 mm | 1 meter |
| 052.10.007 | 10/14 mm | 2,0 mm | 1 meter |
| 052.10.008 | 12/16 mm | 2,0 mm | 1 meter |



TUBINGS - "rubber" "vacuum type"

- Manufactured from natural rubber with thickness required by vacuum applications with durometer 45 A.
- Guarantees excellent chemical and temperature resistance between -25°C to +70°C.

| catalogue number | int. / ext. diameter | wall thickness | pack quantity |
|------------------|----------------------|----------------|---------------|
| 052.11.001 | 6/16 mm | 5,0 mm | 1 meter |
| 052.11.002 | 7/17 mm | 5,0 mm | 1 meter |
| 052.11.003 | 8/18 mm | 5,0 mm | 1 meter |
| 052.11.004 | 10/20 mm | 5,0 mm | 1 meter |



TUBINGS - "silicone" "standard type"

- Manufactured from natural silicone with standard thickness of durometer 45 A.
- Guarantees excellent chemical and temperature resistance between -60°C to +170°C.

| catalogue number | int. / ext. diameter | wall thickness | pack quantity |
|------------------|----------------------|----------------|---------------|
| 052.12.001 | 3/6 mm | 1,5 mm | 1 meter |
| 052.12.002 | 4/7 mm | 1,5 mm | 1 meter |
| 052.12.003 | 5/8 mm | 1,5 mm | 1 meter |
| 052.12.004 | 6/10 mm | 2,0 mm | 1 meter |
| 052.12.005 | 7/11 mm | 2,0 mm | 1 meter |
| 052.12.006 | 8/12 mm | 2,0 mm | 1 meter |
| 052.12.007 | 9/13 mm | 2,0 mm | 1 meter |
| 052.12.008 | 10/14 mm | 2,0 mm | 1 meter |



TUBINGS - "PTFE" - standard type"

- Manufactured from chemically inert PTFE with excellent mechanical strength.
- Guarantees excellent chemical and temperature resistance between -200°C to +280°C.

| catalogue number | int. / ext. diameter | wall thickness | pack quantity |
|------------------|----------------------|----------------|---------------|
| 052.13.001 | 0,5/1 mm | 0,25 mm | 1 meter |
| 052.13.002 | 1/1,5 mm | 0,25 mm | 1 meter |
| 052.13.003 | 1/2 mm | 0,50 mm | 1 meter |
| 052.13.004 | 1,5/3,5 mm | 1,00 mm | 1 meter |
| 052.13.005 | 2/4 mm | 1,00 mm | 1 meter |
| 052.13.006 | 3/5 mm | 1,00 mm | 1 meter |
| 052.13.007 | 4/6 mm | 1,00 mm | 1 meter |
| 052.13.008 | 6/8 mm | 1,00 mm | 1 meter |
| 052.13.009 | 8/10 mm | 1,00 mm | 1 meter |



SCISSORS - "for hose cutting"

- Offers a clean and sharp cut of all kinds of hoses with external diameter range 6 mm to 25 mm.
- The cutter blade is manufactured from stainless steel with two ends. If one cutting end gets blunt, the other side can be used.

| catalogue number | pack quantity |
|------------------|---------------|
| 052.08.002 | 1 piece |



Offers a clean and sharp cut of all kinds of hoses with external diameter range 6 mm to 25 mm.



TUBING CLAMPS - "click-lock"

- Manufactured with a stainless steel clamp and HIPS pressure plate for reliable and precise flow control.
- Can be used wherever the flow rates at tubings with liquids and gases need to be regulated or stopped.
- The micro-screw system enables a fine and stepless adjusted flow control.
- The clamp can be opened and closed at any position without loosening.
- The unique construction enables easy mount of the clamp even when the tubing is already connected to a system.
- Adjustable pressure plate compresses the tubing over a wide area against the stainless steel in order to prevent damages.

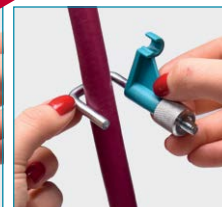

Open the clamp screws

Attach the clamp easily

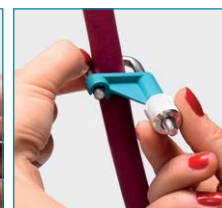

"Click" the clamp

Regulate the flow

| max. hose diameter | blue clamp catalogue no | red clamp catalogue no | orange clamps catalogue no | pack quantity |
|--------------------|-------------------------|------------------------|----------------------------|---------------|
| up to 10 mm | 052.15.010B | 052.15.010R | 052.15.010O | 1 piece |
| up to 15 mm | 052.15.015B | 052.15.015R | 052.15.015O | 1 piece |
| up to 20 mm | 052.15.020B | 052.15.020R | 052.15.020O | 1 piece |



TUBING CLAMPS - "hoffman"

- Manufactured from chrome plated steel for reliable and precise flow control of liquids and gases.
- Can be used wherever the flow rates at tubings with liquids and gases need to be regulated or stopped.
- The swing-open hinged bottom bar enables a fine and stepless adjusted flow control. Variably adjustable up to the total closure of the tubing.
- The unique construction enables easy mount of the clamp even when the tubing is already connected to a system.

| catalogue number | for hose | pack quantity |
|------------------|----------|---------------|
| 052.17.012 | 12 mm | 1 piece |
| 052.17.020 | 20 mm | 1 piece |
| 052.17.030 | 30 mm | 1 piece |



TUBING CLAMPS - "worm drive"

- Ideal clamps for safe fastening and securing tubings on pipe systems or to stopcocks.
- Manufactured from chrome steel according to DIN 3017 standard.

| catalogue number | for hose Ø (mm) | pack quantity |
|------------------|-----------------|---------------|
| 052.16.012 | 8-12 | 1 piece |
| 052.16.016 | 10-16 | 1 piece |
| 052.16.020 | 12-20 | 1 piece |
| 052.16.025 | 16-25 | 1 piece |

TUBE CONNECTORS - "L" - "Y" - "T" - "X"

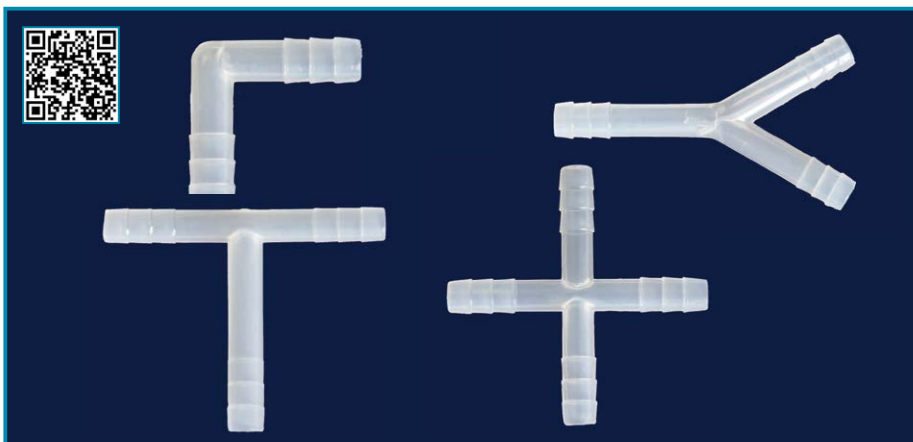

- Manufactured from clear polypropylene for safe connection of tubings with exactly same inner diameter.
- 4 available models provide excellent, leak-proof and multi-functional connection.

| ID hose diameters | "L" model catalogue no | "Y" model catalogue no | "T" model catalogue no | "X" model catalogue no | pack quantity |
|-------------------|------------------------|------------------------|------------------------|------------------------|---------------|
| 6 mm | 052.22.006 | 052.23.006 | 052.24.006 | 052.25.006 | 1 piece |
| 8 mm | 052.22.008 | 052.23.008 | 052.24.008 | 052.25.008 | 1 piece |
| 10 mm | 052.22.010 | 052.23.010 | 052.24.010 | 052.25.010 | 1 piece |



STOPPERS
"rubber"

➤ Manufactured from additive free, best quality natural rubber according to DIN 12871 standard with durometer 40 A.

➤ Guarantees excellent chemical and temperature resistance between -25°C to +70°C.



STOPPERS
"silicone"

➤ Manufactured from chemically inert, autoclavable, best quality natural silicone according to DIN 12871 standard with durometer 50 A.

➤ Guarantees excellent chemical and temperature resistance between -60°C to +170°C.



STOPPERS
"cork"

➤ Manufactured from non-porous, additive free, best quality natural cork according to DIN 12871 standard dimensions.

➤ Offers multi advantages with their light weight yet robust construction. Can be easily drilled.



STOPPERS -
"turn - over flange"

➤ Manufactured from chemically inert, autoclavable, best quality natural silicone.

➤ Guarantees excellent chemical and temperature resistance between -60°C to +170°C.

➤ They provide perfect tight sealing even with poorly finished rims preventing accidental openings.

➤ Offers optional sealing both from inside or outside of the tube wall.

➤ For sampling the upper septum can be easily punctured. Flexible body material reseals.

| bottom Ø mm | top Ø mm | height mm | stoppers rubber | stoppers silicone | pack quantity | stoppers cork | pack quantity |
|-------------|----------|-----------|-----------------|-------------------|---------------|---------------|---------------|
| 3,5 | 6,5 | 15,0 | 051.20.001 | 051.22.001 | 10 pcs. | 051.23.001 | 10 pcs. |
| 5,0 | 9,0 | 20,0 | 051.20.002 | 051.22.002 | 10 pcs. | 051.23.002 | 10 pcs. |
| 8,0 | 12,0 | 20,0 | 051.20.003 | 051.22.003 | 10 pcs. | 051.23.003 | 10 pcs. |
| 10,5 | 14,5 | 20,0 | 051.20.004 | 051.22.004 | 10 pcs. | 051.23.004 | 10 pcs. |
| 12,5 | 16,5 | 20,0 | 051.20.005 | 051.22.005 | 10 pcs. | 051.23.005 | 10 pcs. |
| 14,0 | 18,0 | 20,0 | 051.20.006 | 051.22.006 | 10 pcs. | 051.23.006 | 10 pcs. |
| 17,0 | 22,0 | 25,0 | 051.20.007 | 051.22.007 | 10 pcs. | 051.23.007 | 10 pcs. |
| 18,0 | 24,0 | 30,0 | 051.20.008 | 051.22.008 | 10 pcs. | 051.23.008 | 10 pcs. |
| 21,0 | 27,0 | 30,0 | 051.20.009 | 051.22.009 | 10 pcs. | 051.23.009 | 10 pcs. |
| 23,0 | 29,0 | 30,0 | 051.20.010 | 051.22.010 | 10 pcs. | 051.23.010 | 10 pcs. |
| 26,0 | 32,0 | 30,0 | 051.20.011 | 051.22.011 | 10 pcs. | 051.23.011 | 10 pcs. |
| 29,0 | 35,0 | 30,0 | 051.20.012 | 051.22.012 | 10 pcs. | 051.23.012 | 10 pcs. |
| 31,0 | 38,0 | 35,0 | 051.20.013 | 051.22.013 | 10 pcs. | 051.23.013 | 10 pcs. |
| 36,0 | 44,0 | 40,0 | 051.20.014 | 051.22.014 | 10 pcs. | 051.23.014 | 10 pcs. |
| 41,0 | 49,0 | 40,0 | 051.20.015 | 051.22.015 | 6 pcs. | 051.23.015 | 10 pcs. |
| 47,0 | 55,0 | 40,0 | 051.20.016 | 051.22.016 | 6 pcs. | 051.23.016 | 10 pcs. |
| 50,5 | 59,5 | 45,0 | 051.20.017 | 051.22.017 | 6 pcs. | 051.23.017 | 10 pcs. |
| 56,0 | 65,0 | 45,0 | 051.20.018 | 051.22.018 | 6 pcs. | 051.23.018 | 10 pcs. |
| 60,0 | 70,0 | 50,0 | 051.20.019 | 051.22.019 | 6 pcs. | 051.23.019 | 10 pcs. |
| 64,5 | 75,5 | 55,0 | 051.20.020 | 051.22.020 | 3 pcs. | 051.23.020 | 10 pcs. |
| 71,0 | 83,0 | 60,0 | 051.20.021 | 051.22.021 | 3 pcs. | 051.23.021 | 10 pcs. |
| 79,0 | 92,0 | 65,0 | 051.20.022 | 051.22.022 | 3 pcs. | 051.23.022 | 10 pcs. |

how to select proper size stopper?

Attached table indicates technical dimensions of NS joints. Please examine the related NS size and select the right stopper from the catalogue list.

Please pay attention to select a larger stopper for perfect closure of the joint.

| NS size | total height | diameter narrow end | diameter wide end |
|---------|--------------|---------------------|-------------------|
| 10/19 | 19,00 mm | 8,02 mm | 10,00 mm |
| 12/21 | 21,00 mm | 10,50 mm | 12,50 mm |
| 14/23 | 23,00 mm | 12,17 mm | 14,50 mm |
| 19/26 | 26,00 mm | 16,01 mm | 18,80 mm |
| 24/29 | 29,00 mm | 20,95 mm | 24,00 mm |
| 29/32 | 32,00 mm | 26,12 mm | 29,20 mm |
| 34/35 | 35,00 mm | 30,77 mm | 34,50 mm |



| catalogue number | effective diameter | pack quantity |
|------------------|--------------------|---------------|
| 051.26.001 | 7,1 mm | 10 pieces |
| 051.26.002 | 10,2 mm | 10 pieces |
| 051.26.003 | 12,7 mm | 10 pieces |
| 051.26.004 | 14,9 mm | 10 pieces |
| 051.26.005 | 15,9 mm | 10 pieces |
| 051.26.006 | 19,4 mm | 10 pieces |
| 051.26.007 | 23,7 mm | 10 pieces |
| 051.26.008 | 30,7 mm | 10 pieces |

STOPPERS - "hallow glass" - "hexagonal"

- Manufactured from borosilicate glass according to DIN 12252.
- Hexagonal flat head prevents the stopper from rolling on the bench and avoids the breakage risk.
- A pointed, round formed "drip-tip" stopper lower end guarantees return of the adhered liquid back to the flasks.

| NS size | stoppers clear | pack quantity | stoppers amber | pack quantity |
|----------|----------------|---------------|----------------|---------------|
| NS 10/19 | 051.03.001 | 10 pieces | 051.04.001 | 1 piece |
| NS 12/21 | 051.03.002 | 10 pieces | 051.04.002 | 1 piece |
| NS 14/23 | 051.03.003 | 10 pieces | 051.04.003 | 1 piece |
| NS 19/26 | 051.03.004 | 10 pieces | 051.04.004 | 1 piece |
| NS 24/29 | 051.03.005 | 10 pieces | 051.04.005 | 1 piece |
| NS 29/32 | 051.03.006 | 10 pieces | 051.04.006 | 1 piece |
| NS 34/35 | 051.03.007 | 10 pieces | 051.04.007 | 1 piece |

**STOPPERS - "rubber" - "drilled"**

- Manufactured from additive free, best quality natural rubber according to DIN 12871 standard with durometer 40 A.
- The drilled hole offers labour and time saving applications.

| catalogue number | bottom Ø mm | top Ø mm | hole Ø mm | pack quantity |
|------------------|-------------|----------|-----------|---------------|
| 051.21.001 | 10,5 | 14,5 | 3,0 | 1 piece |
| 051.21.002 | 12,5 | 16,5 | 3,0 | 1 piece |
| 051.21.003 | 14,0 | 18,0 | 3,0 | 1 piece |
| 051.21.004 | 17,0 | 22,0 | 4,0 | 1 piece |
| 051.21.005 | 18,0 | 24,0 | 4,0 | 1 piece |
| 051.21.006 | 21,0 | 27,0 | 5,0 | 1 piece |
| 051.21.007 | 23,0 | 29,0 | 5,0 | 1 piece |
| 051.21.008 | 26,0 | 32,0 | 6,0 | 1 piece |
| 051.21.009 | 29,0 | 35,0 | 6,0 | 1 piece |
| 051.21.010 | 31,0 | 38,0 | 7,0 | 1 piece |

**CAPS - "polypropylene"**

- Manufactured from polypropylene for perfect and tight closure of GL 45 screw necked laboratory bottles.



- Large ridges on the cap outer surface guarantees for increased grip and fast closure.
- Color coded caps enable fast, easy and practical identification of bottle content.

| catalogue number | color | pack quantity |
|------------------|--------|---------------|
| 051.09.45R | red | 10 pieces |
| 051.09.45Y | yellow | 10 pieces |
| 051.09.45B | blue | 10 pieces |
| 051.09.45G | green | 10 pieces |

STOPPERS "polyethylene"

- Manufactured from polyethylene for perfect tight sealing for all NS joints.
- Hexagonal flat head prevents the stopper from rolling on the bench and avoids the breakage risk.

- The hallow form of the stopper head collects the adhered liquid and prevents the possible damage risk of the laboratory benches.

| catalogue number | NS size | pack quantity |
|------------------|----------|---------------|
| 051.08.010 | NS 10/19 | 10 pieces |
| 051.08.012 | NS 12/21 | 10 pieces |
| 051.08.014 | NS 14/23 | 10 pieces |
| 051.08.019 | NS 19/26 | 10 pieces |
| 051.08.024 | NS 24/29 | 10 pieces |
| 051.08.029 | NS 29/32 | 10 pieces |

**STOPPERS - "flange" - "polyethylene"**

- Manufactured from polyethylene for perfect tight sealing of specially test tubes. Grooved, conical body shape and large size flanges on the stopper perfectly touch to the walls of the tubes and offer the best leak-proof sealing.

| catalogue number 13 mm | catalogue number 16 mm | color | pack quantity |
|------------------------|------------------------|-----------|---------------|
| 051.10.001 | 051.11.001 | clear | 100 pieces |
| 051.10.002 | 051.11.002 | dark blue | 100 pieces |
| 051.10.003 | 051.11.003 | yellow | 100 pieces |
| 051.10.004 | 051.11.004 | red | 100 pieces |
| 051.10.005 | 051.11.005 | green | 100 pieces |

lab consumables & labware

CLING FILM

- Manufactured from PVC based resin with extremely good stretching, and adhesion characteristics. Perfect tool for sealing and wrapping of various labware.
- Offers an easy use and easy for unravel application.
- Stretches and widens up 50% of original length. Clings around the labware and seals labware with leak-proof tightness.
- Waterproof. Chemically inert and resistant to most organic solvents and caustic agents.
- Remains flexible in moderate freezing temperatures. Can resist up to 75°C.



Offers extremely good stretching, and adhesion characteristics. Perfect tool for sealing and wrapping of various labware.

| catalogue number | roll width | roll length | foil thickness | pack quantity |
|------------------|------------|-------------|----------------|---------------|
| 058.03.001 | 300 mm | 90 m | 0,011 mm | 1 piece |



SEALING FILM - "parafilm"

- Most common sealing film used in laboratories.
- Manufactured from polioefin and paraffin mixture.
- Guarantees excellent chemical to salt, inorganic and alkaline solutions up to 48 hours and offers temperature resistance between -45°C to +500°C.
- Stretches and widens up 200% of original length.
- Clings around flask necks circumference and seal irregular perimeters of flasks, erlenmeyers, bottles, beakers etc. with leak-proof tightness.
- Also prevents breakage risk of flask neck and spillage of flask contents in case of a tilt over.

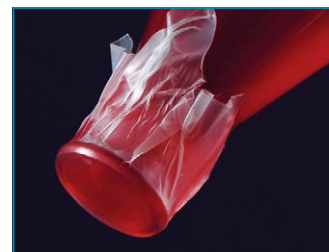

Clings around flask neck circumference and seal irregular perimeters of flasks, erlenmeyers, bottles, beakers etc. with leak-proof tightness.

| catalogue number | width | length | pack quantity | box quantity |
|------------------|--------|--------|---------------|--------------|
| 058.01.001 | 50 mm | 75 mt | 1 piece | 24 pieces |
| 058.01.002 | 100 mm | 38 mt | 1 piece | 12 pieces |





PARAFILM DISPENSER

- Perfect tool for safe and easy cutting of 100 mm and 50 mm width parafilms.
- Keeps the remaining part unaffected from environmental conditions.
- Can cut one roll of 100 mm or simultaneously 2 rolls of 50 mm width parafilm.
- Manufactured from ABS and featured with a double action cutting blade that slides and cuts.
- The clear hinged lid enables visual control of the remaining parafilm roll.
- Unique design of the blade holder guarantees easy handling.
- The cutting blade can easily slide in both directions providing a clean and uninterrupted cut.
- The cutting blade is embedded in a holding block ensuring finger safety.

| dispenser cat. number | dimensions | body color | pack quantity |
|-----------------------|--------------------|------------|---------------|
| 058.02.001B | 120 x 140 x 140 mm | blue | 1 piece |
| 058.02.001P | 120 x 140 x 140 mm | purple | 1 piece |
| 058.02.001R | 120 x 140 x 140 mm | ruby | 1 piece |



Push the cutting mechanism of the dispenser backwards.



Place the parafilm and move the mechanism back to original position.



Pull out the necessary length from dispenser for cutting.



Parafilm is cut with one movement of the blade from side to side.

SPARE CUTTING BLADE

- Unique design of the blade holder guarantees easy handling.
- The cutting blade is embedded in a holding block ensuring finger safety.
- It is recommended that after a certain use period the cutting blade should be exchanged for better cutting performance.



| catalogue number | pack quantity |
|------------------|---------------|
| 058.02.101 | 1 piece |

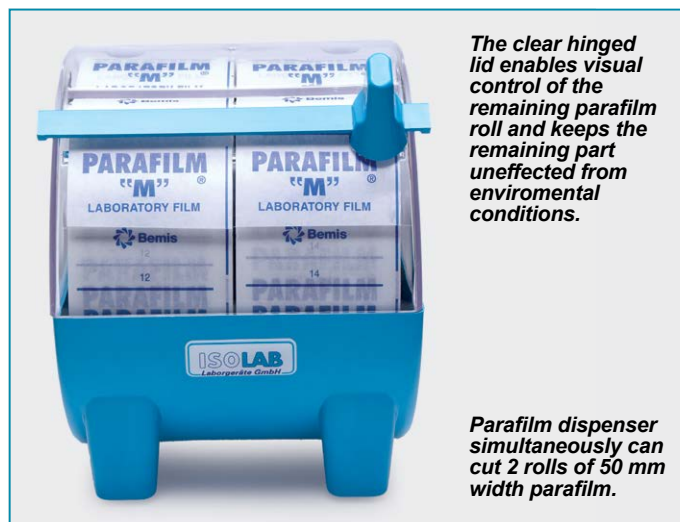

The clear hinged lid enables visual control of the remaining parafilm roll and keeps the remaining part unaffected from environmental conditions.

Parafilm dispenser simultaneously can cut 2 rolls of 50 mm width parafilm.

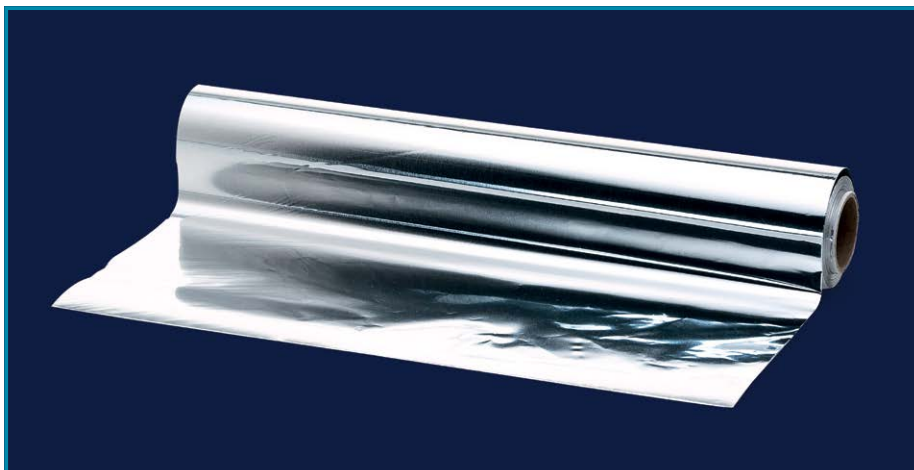

FOIL ROLL - "aluminium"

- Manufactured from polished, pure aluminium sheet for wrapping and sealing of various labware.
- Due to the characteristics also convenient to form temporary containers.
- Offers ideal use during autoclaving, heating, freezing applications.
- Approximate foil thickness is 0,018 mm.

| catalogue number | roll width | roll length | pack quantity |
|------------------|------------|-------------|---------------|
| 058.04.001 | 300 mm | 45 m | 1 piece |



FOIL DISPENSER

- Perfect dispenser to be used for aluminium folios and cling films.
- Easy and safe to use; Place the roll inside the box, press the lid, pull the necessary length out and start cutting.
- An easy and clean cut without waste is guaranteed with sharp cutting teeth.
- Light weight ensures easy handling with one hand.
- Compact design requires limited working space area.

| catalogue number | max. roll width | pack quantity |
|------------------|-----------------|---------------|
| 058.02.002 | 300 mm | 1 piece |



ALUMINIUM DISCS

- Manufactured from polished, pure aluminium sheet in circular form for sealing of beakers, erlenmeyers, flasks and other various labware necks.
- Guarantees perfect, dust-free seal and offers ideal use during autoclaving, heating, freezing applications.
- Discs do not stick to each other since they are interleaved with protective tissue papers.
- Approximate foil thickness is 0,03 mm.

Guarantees perfect, dust-free seal and offers ideal use during autoclaving, heating, freezing applications.



| catalogue number | diameter | pack quantity |
|------------------|----------|---------------|
| 058.05.080 | 80 mm | 1000 pieces |
| 058.05.100 | 100 mm | 1000 pieces |
| 058.05.125 | 125 mm | 1000 pieces |
| 058.05.150 | 150 mm | 1000 pieces |

PEN - "engraving"



Easy to operate; hold the pen tightly on the surface, press the power button, let the tip rotate with high speed and provide a permanent inscription on the surface.

- Offers unlimited application for writing, marking and engraving on almost all surfaces without applying pressure.
- Easy to operate; hold the pen tightly on the surface, press the power button, let the tip rotate with high speed and provide a permanent inscription on the surface.
- The inscriptions and markings will not be effected by chemicals or sunshine and stay forever.
- Cordless battery power enables both indoor and outdoor applications. Operates with 2x"AA" battery which is not supplied with the pen.

catalogue
number
099.01.001

pack
quantity
1 piece



PENS - "permanent-ink"- "double tip"

- All purpose pens with round fiber tip for labelling, writing, painting on virtually all materials including glass, metal and plastic surfaces.
- Consists of 2 tips at each end. The "fine" tip at one end has 0,6 mm stroke. The "medium" tip at the other hand has 1,5 mm stroke.
- The pen ink is odorless, smudge-proof, and quick drying. Tips do not dry even if left uncapped for prolonged hours.



Supplied as a pack of 3 pens with red, blue and black colors.

catalogue
number
099.01.002

pack
quantity
set of 3 pens

PENS - "marker"- "double tip"

- All purpose pens with flat fiber tip for marking texts on paper.
- Consists of 2 tips at each end. The "fine" tip at one end has 0,9 mm stroke. The "medium" tip at the other hand has 2,7 mm stroke.
- Airtight pen cap prevents air flow and for extended life cycle.
- Supplied as a pack of 5 pens with purple, blue, green, pink and yellow colors.



Supplied as a pack of 5 pens with purple, blue, green, pink and yellow colors.

catalogue
number
099.01.006

pack
quantity
set of 5 pens



PENS - "permanent-ink"- "single tip"

- All purpose pens with round fiber tip for labelling, writing, painting on virtually all materials including glass, metal and plastic surfaces.
- Consists of a single tip at one end with 3 mm stroke.
- The pen ink is odorless, smudge-proof, and quick drying. Tip do not dry even if left uncapped for prolonged hours.

catalogue
number
099.01.003

pack
quantity
set of 3 pens



Supplied as a pack of 3 pens with blue, red and black colors.

SEALING TAPE - "for petri dishes"



- Perfect tool to protect petri dish interior contents. Stretches and widens up 50% of original length.
- Clings around the petri dish body and seals irregular perimeters of petri dishes.
- Waterproof. Chemically inert and resistant to most organic solvents and caustic agents.
- Remains flexible in moderate freezing temperatures. Can resist up to 100°C.

| catalogue number | tape width | pack quantity |
|------------------|------------|---------------|
| 058.07.001 | 19 mm | 1 piece |

SAFETY LABELS - "GHS pictograms"



- Designed for easy identification of materials with the universally applicable hazard symbols.
- Manufactured from 100 µm glossy PE film with acrylic resin adhesive back.
- Expands and retracts together with temperature fluctuations and guarantees always a strong adhesive bond.
- Chemically inert, water proof, moisture and most solvents and caustic agents. Can be used between - 20°C to + 80°C temperature range.

- Adheres to any clean surface including PTFE coated surfaces without cracking, peeling and degrading. Peels off without leaving any sticky residue.

| product type | signal word | label size 26x37 mm | label size 37x52 mm |
|--------------|-------------|---------------------|---------------------|
| GHS 1 | warning | 099.11.001 | 099.11.003 |
| GHS 1 | danger | 099.11.002 | 099.11.004 |
| GHS 2 | warning | 099.12.001 | 099.12.003 |
| GHS 2 | danger | 099.12.002 | 099.12.004 |
| GHS 3 | warning | 099.13.001 | 099.13.003 |
| GHS 3 | danger | 099.13.002 | 099.13.004 |
| GHS 4 | warning | 099.14.001 | 099.14.003 |
| GHS 5 | warning | 099.15.001 | 099.15.003 |
| GHS 5 | danger | 099.15.002 | 099.15.004 |
| GHS 6 | danger | 099.16.002 | 099.16.004 |
| GHS 7 | warning | 099.17.001 | 099.17.003 |
| GHS 8 | warning | 099.18.001 | 099.18.003 |
| GHS 8 | danger | 099.18.002 | 099.18.004 |
| GHS 9 | warning | 099.19.001 | 099.19.003 |

By using GHS pictograms you can label all dangerous and hazardous products in your lab and avoid injuries.

"DANGER" word indicates a hazardous situation which if, not avoided will result in death or serious injury.

"WARNING" word indicates a hazardous situation which if, not avoided will result in serious injury.

- Each pictogram is defined with four (German / English / French / Spanish) languages. Supplied as rolls of 250 stickers packed in a dispenser box for practice use.



GHS 01
explosive
warning
danger



GHS 02
flame
warning
danger



GHS 03
oxidizing
warning
danger



GHS 04
gas cylinder
warning



GHS 05
corrosive
warning
danger



GHS 06
toxicity
danger



GHS 07
irritation
warning



GHS 08
health hazardous
warning
danger



GHS 09
environment hazardous
warning

SEALING TAPE - "reinforced"



1- Reinforced Kraft Paper tape: With reinforced layer with fiberglass lamination for excellent resistance to abrasion while transporting. Can adhere to any surface due to the strong adhesive backsurface. Suitable for heavy duty packaging, bundling etc.

2- Reinforced Aluminium tape: Made with layers of aluminum, fiberglass yarn and Kraft paper. Resistant to U.V degradation, moisture, many chemicals. Can adhere to any surface due to the strong adhesive backsurface. Also suitable for heat/cold reflective wrap along or over insulation, wrapping any product for protection against heat, water, dust and chemicals.

| catalogue number | tape name | tape width | tape length | pack quantity |
|------------------|-----------|------------|-------------|---------------|
| 099.04.004 | Kraft | 60 mm | 50 mt | 1 roll |
| 099.04.005 | Aluminum | 50 mm | 20 mt | 1 roll |



CUTTING TOOL - "for tapes"

- A practice cutting tool for all mentioned tapes in this page.

- Practical to use. Easy to handle. Just place the tape in position and start using immediately.

| catalogue number | pack quantity |
|------------------|---------------|
| 099.04.001 | 1 piece |

TAPES - "for labelling" - "roll"

- Manufactured from colored paper with special resin adhesive that resists to moisture and most solvents.
- Can be used between -5°C to + 110°C temperature range. Also with stands steam autoclaving cycle and gamma irradiation.
- Adheres to any clean surface including PTFE coated surfaces and peels off without leaving any sticky residue.
- Accepts writing from almost all pen types such as pencil, ball point pen, solvent ink marker etc.
- Markings remain absolutely legible under the most demanding laboratory conditions.
- Supplied as white color or as "rainbow pack" pack of 6 different colors matching the universal hazard color codes. (yellow for chemical reactivity / blue for health hazards / green for safety / red for flammability / orange tape for biohazard and white for general purpose.)

| catalogue number | tape width | tape length | tape color | box quantity |
|------------------|------------|-------------|----------------|----------------|
| 099.02.001 | 19 mm | 30 meter | rainbow colors | set of 6 rolls |
| 099.02.011 | 19 mm | 30 meter | white | 1 roll |

TAPE DISPENSER

- Suitable for holding and releasing the tape to be cut to users desire.
- The core perfectly fits to the inner diameter of the tape and keeps the tape rigidly.
- Platform includes a writing surface. Finger holes on the platform enable quick release of the tape and accelerate the cutting step.
- Featured with a cut-off edge for efficient cutting of the tape.
- A weighted base with non-skid pads prevent sliding or lifting.

| Over all dimensions: | catalogue number | pack quantity |
|------------------------------|------------------|---------------|
| 155x250x100 mm. | 099.02.002 | 1 piece |
| Cutting platform dimensions: | | |
| 155x110 mm. | | |

LABELS - "rectangular form"

- Manufactured from polypropylene flexible paper with acrylic resin adhesive back.
- This unique combination expands and retracts together with temperature fluctuations and guarantees always a strong adhesive bond.
- Chemically inert, resists to water, moisture and most organic solvents and caustic agents. Can be used between -96°C to +121°C temperature range. Also withstands steam autoclaving cycle and gamma irradiation.
- Adheres to any clean surface including PTFE coated surfaces without cracking, peeling and degrading. Peels off without leaving any sticky residue.

| catalogue number | label length | label width | label color | roll quantity | pack quantity |
|------------------|--------------|-------------|-------------|---------------|---------------|
| 099.03.050 | 30 mm | 50 mm | white | 1000 labels | 1 roll |
| 099.03.072 | 72 mm | 40 mm | white | 1000 labels | 1 roll |
| 099.03.090 | 90 mm | 50 mm | white | 1000 labels | 1 roll |

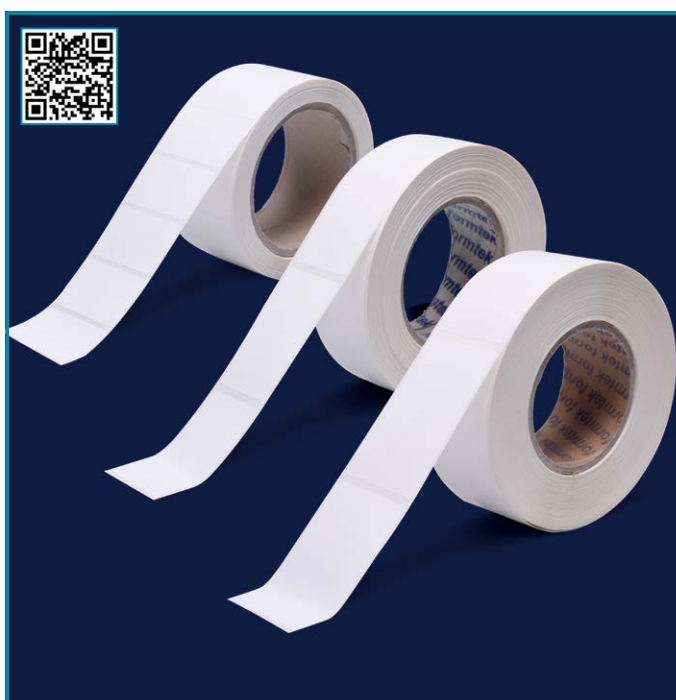
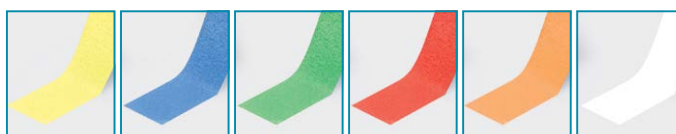



LABEL - "circular form"

- Manufactured from polyfiber grade flexible paper with acrylic resin adhesive back.
- This unique combination expands and retracts together with temperature fluctuations and guarantees always a strong adhesive bond.
- Chemically inert, resists to water, moisture and most organic solvents and caustic agents. Can be used between -196°C to +80°C temperature range.
- Adheres to any clean surface including PTFE coated surfaces without cracking, peeling and degrading. Peels off without leaving any sticky residue.
- Recommended to be used on tube caps with different diameters. Supplied as rolls packed in a dispenser box for practical use.
- Supplied as white color or as "rainbow pack" pack of 6 different colors matching the universal hazard color codes. (yellow for chemical reactivity / blue for health hazards / green for safety / red for flammability / orange tape for biohazard and white for general purpose.)



| catalogue number | label diameter | recommended for | label color | roll quantity | pack quantity |
|------------------|----------------|--------------------|--------------|---------------|---------------|
| 099.05.009 | 9,5 mm | 0,5 ml tubes | white | 1000 labels | 1 roll |
| 099.05.109 | 9,5 mm | 0,5 ml tubes | rainbow pack | 1000 labels | 6 rolls |
| 099.05.013 | 13 mm | 1,5 & 2,0 ml tubes | white | 1000 labels | 1 roll |
| 099.05.113 | 13 mm | 1,5 & 2,0 ml tubes | rainbow pack | 1000 labels | 6 rolls |
| 099.05.019 | 19 mm | 15 ml tubes | white | 500 labels | 1 roll |
| 099.05.025 | 25 mm | 50 ml tubes | white | 500 labels | 1 roll |



LABEL DISPENSER

- Perfect organizer for fast and efficient use of labels. Manufactured from clear acrylic and holds 6 label box.
- Drop the label box in the label dispenser and feed the paper through the slot.
- The writing surface enables easy and clean writing on the label. The sharp cutting edge helps to tear off the labels.
- A weighted base with non-skid pads prevent sliding or lifting.
- Supplied without pen.

| catalogue number | pack quantity |
|------------------|---------------|
| 099.50.001 | 1 piece |



LABEL REMOVAL

- A perfect tool for effortless removal self adhesive labels.
- It works on the adhesive and quickly and gently dissolves adhesive of the label without leaving the sticky residue of the adhesive on the surface.
- Can be used on glass, porcelain, metal, wood, cardboard and some plastic surfaces.
- Not recommended to be used with polystyrene.

| catalogue number | pack quantity |
|------------------|---------------|
| 099.60.001 | 1 piece |



LABELS - "rectangular form"

LABELS - "rectangular form"

- Manufactured from polyfiber grade flexible paper with acrylic resin adhesive back.
- This unique combination expands and retracts together with temperature fluctuations and guarantees always a strong adhesive bond.
- Chemically inert, resists to water, moisture and most organic solvents and caustic agents.
- Can be used between -40°C to +121°C temperature range.
- Also withstands steam autoclaving cycle and gamma irradiation.
- Adheres to any clean surface including PTFE coated surfaces without cracking, peeling and degrading. Peels off without leaving any sticky residue.
- Recommended to be used on flat or round surfaces with different diameters.
- Supplied as 1000 label rolls packed in a dispenser box for practice use.

- Manufactured from polyfiber grade flexible paper with acrylic resin adhesive back.
- This unique combination expands and retracts together with temperature fluctuations and guarantees always a strong adhesive bond.
- Chemically inert, resists to water, moisture and most organic solvents and caustic agents.
- Can be used between -196°C to +80°C temperature range.
- Also with stands gamma irradiation.
- Adheres to any clean surface including PTFE coated surfaces without cracking, peeling and degrading. Peels off without leaving any sticky residue.
- Recommended specially to be used with cryo vials or on any flat or round surface.
- Supplied as 1000 label rolls packed in a dispenser box for practice use.

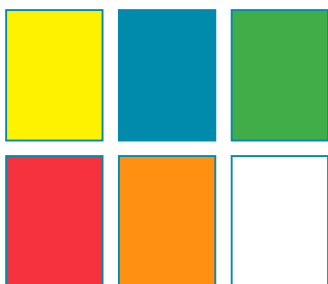

Supplied as white color or as "rainbow pack" pack of 6 different colors matching the universal hazard color codes. (yellow for chemical reactivity / blue for health hazards / green for safety / red for flammability / orange tape for biohazard and white for general use).

"rainbow pack offers 6 colors"

| catalogue number | label dimensions | recommended tube volume | label color | pack quantity |
|------------------|------------------|-------------------------|-------------|---------------|
| 099.07.033 | 33x13 mm | 1,5 & 2,0 ml | white | 1 roll |
| 099.07.038 | 38x19 mm | general purpose | white | 1 roll |

| catalogue number | label dimensions | recommended tube volume | label color | pack quantity |
|------------------|------------------|-------------------------|--------------|---------------|
| 099.06.024 | 24x13 mm | 0,5 ml | white | 1 roll |
| 099.06.124 | 24x13 mm | 0,5 ml | rainbow pack | 6 rolls |
| 099.06.033 | 33x13 mm | 1,5 & 2,0 ml | white | 1 roll |
| 099.06.133 | 33x13 mm | 1,5 & 2,0 ml | rainbow pack | 6 rolls |
| 099.06.038 | 38x19 mm | general purpose | white | 1 roll |

GHS pictograms can be selected from catalogue page no 74.





BAGS - "autoclavable" - "plain"

- Manufactured from a special grade of polypropylene with high tear and puncture resistance.
- Commonly used for safe disposal of contaminated laboratory waste such as used petri dishes, test tubes, sample vials, cultureware and other biohazardous products.
- Also offers an alternative for storing and transportation of various products.
- Can resist pressure differences during autoclaving.
- Bags should be left open during autoclaving.
- Strong side seams stand safe under pressure or weight and guarantee safe holding of bag content.

| catalogue number | bag type | width x height | pack quantity |
|------------------|----------|----------------|---------------|
| 039.30.001 | plain | 200 x 300 mm | 100 pieces |
| 039.30.002 | plain | 300 x 600 mm | 100 pieces |
| 039.30.003 | plain | 400 x 700 mm | 100 pieces |
| 039.30.004 | plain | 590 x 890 mm | 100 pieces |
| 039.30.005 | plain | 690 x 1100 mm | 100 pieces |



BAGS - "autoclavable" - "imprinted"

- Manufactured from a special grade of polypropylene with high tear and puncture resistance.
- Commonly used for safe disposal of contaminated laboratory waste such as used petri dishes, test tubes, sample vials, cultureware and other biohazardous products.
- Also offers an alternative for storing and transportation of various products.
- Can resist pressure differences during autoclaving.
- Bags should be left open during autoclaving.
- Strong side seams stand safe under pressure or weight and guarantee safe holding of bag content
- On the bag surface a large writing area and necessary warnings are imprinted.

| catalogue number | bag type | width x height | pack quantity |
|------------------|-----------|----------------|---------------|
| 039.20.001 | imprinted | 320 x 640 mm | 50 pieces |
| 039.20.002 | imprinted | 420 x 600 mm | 50 pieces |
| 039.20.003 | imprinted | 555 x 745 mm | 50 pieces |



BAG STAND "adjustable height"

- Manufactured from stainless steel for use with the bags with catalogue no **039.30.001**.
- Ideal for disposal of small objects during daily use at laboratories.
- Due to it's compact size bag stand does not cover space on the laboratory bench.
- The height of the stand is adjustable with the help of adjusting screw.

| catalogue number | stand diameter | pack quantity |
|------------------|----------------|---------------|
| 062.30.002 | 125 ± 5 mm | 1 piece |



BAGS - "with wire closure" - "sterile"

- Manufactured from clear and thick polyethylene to be used with chemical, medical, food, biological samples of liquid, powder, solid and paste form.
- With their exceptionally transparent, odour-tight, tear-proof and leakproof properties they offer alternative solutions to laboratory bottles and other flasks.
- Sterilized with gamma irradiation, **free of RNase, DNase, and pyrogene**. Can be frozen to -80°C.
- Unique metal closure system guarantees leak-proof closure preventing odors and any leakage to exterior environment.
- Write-on white patch offers a practical area for writing specific marks and notes.



| catalogue number | volume | width x height | wall thickness | wire thickness | packing specifications |
|------------------|---------|----------------|----------------|----------------|----------------------------------|
| 039.21.001 | 60 ml | 76 x 127 mm | 70 microns | 0,5 mm | 500 pcs / pack - 1000 pcs / case |
| 039.21.002 | 120 ml | 76 x 178 mm | 70 microns | 0,5 mm | 500 pcs / pack - 1000 pcs / case |
| 039.21.003 | 540 ml | 114 x 229 mm | 70 microns | 0,5 mm | 500 pcs / pack - 1000 pcs / case |
| 039.21.004 | 720 ml | 140 x 229 mm | 90 microns | 0,5 mm | 500 pcs / pack - 1000 pcs / case |
| 039.21.005 | 1650 ml | 180 x 300 mm | 100 microns | 0,5 mm | 250 pcs / pack - 1000 pcs / case |

BAGS - "with zip-lock" - "with write-on patch"

- Manufactured from clear and robust polyethylene to be used with chemical, medical, food, biological samples of liquid, powder, solid and paste form.
- Non-sterile, ideal for dust-free storing, collecting, protecting and shipping of specimens and samples.
- Write-on white patch offers a practical area for writing specific marks and notes.
- Rim channel seal can be opened and closed repeatedly with the guarantee of leak-proof closure.



| catalogue number | w x L (mm) | pack quantity |
|------------------|------------|---------------|
| 039.08.100 | 70x100 | 100 pieces |
| 039.08.150 | 100x150 | 100 pieces |
| 039.08.220 | 150x220 | 100 pieces |
| 039.08.300 | 200x300 | 100 pieces |

Color coded in 4 different colors for fast and easy identification.



BAG LATCHES

- Manufactured from a special grade of polypropylene for quick closing of the bags. Practical closing system guarantees perfect and tight closure of the bags.



BAG LOCKS

- Manufactured from a special grade of polypropylene for quick closing of the bags.
- Unique design enables damage free opening and multiple use of the same bag lock.



Offers very tight sealing of the bags. Can be opened again once closed.



| catalogue number | length | width | pack quantity |
|------------------|--------|--------|---------------|
| 039.34.105 | 105 mm | 2,5 mm | 100 pieces |
| 039.34.150 | 150 mm | 2,5 mm | 100 pieces |

| catalogue number | length | width | pack quantity |
|------------------|--------|-------|---------------|
| 039.35.075 | 75 mm | 15 mm | 4 pieces |
| 039.35.145 | 145 mm | 15 mm | 4 pieces |
| 039.35.200 | 200 mm | 15 mm | 4 pieces |

lab consumables & labware

BAGS - "homogenization" - "sterile"

- Manufactured from polyethylene. Specially designed for fast and effective crushing of solid samples to the liquid phase.
- Sterilized with gamma irradiation, **free of RNase, DNase, and pyrogene.**
- Even at low temperatures they maintain the stability of the specimen's microbiological status.
- While working with infectious samples, bags can be sealed by any ordinary bag sealer to prevent the escape of aerosols.
- **Alternative 3 products:**
 - Bag without filter
 - Bag with side filter
 - Bag with full filter

bag with no filter



Bags without filter are generally used for standard and common practises.

bag with side (lateral) filter



Bags with side (lateral) filter divides the bag in 2 non-equal compartments. They are suitable for small samples such as PCR applications.

bag with full (page) surface filter



Bags with full (page) filter divides in 2 equal compartments. Solid sample remains in it's side, while the liquid phase moves to the other side.

| catalogue number | bag type | volume | width x height | wall thickness | pore size | packing specifications |
|------------------|-------------|--------|----------------|----------------|---------------|--------------------------------|
| 039.23.003 | no filter | 400 ml | 190 x 300 mm | 70 microns | - | 50 pcs / pack - 500 pcs / case |
| 039.23.002 | side filter | 400 ml | 190 x 300 mm | 70 microns | < 250 microns | 50 pcs / pack - 500 pcs / case |
| 039.23.001 | full filter | 400 ml | 190 x 300 mm | 70 microns | < 280 microns | 50 pcs / pack - 500 pcs / case |

ACCESSORIES - "for homogenization bags"

➤ **BAG STAND - "stainless steel"**: Manufactured from AISI 304 grade stainless steel for hanging homogenization bags.

➤ Can carry 4 homogenisation bags of any type.

| catalogue number | pack quantity |
|------------------|---------------|
| 608.01.101 | 1 piece |

➤ **BAG STAND - "acrylic"**: Manufactured durable acrylic for hanging homogenisation bags.

➤ Can carry 10 homogenisation bags of any type.

| catalogue number | pack quantity |
|------------------|---------------|
| 608.01.102 | 1 piece |

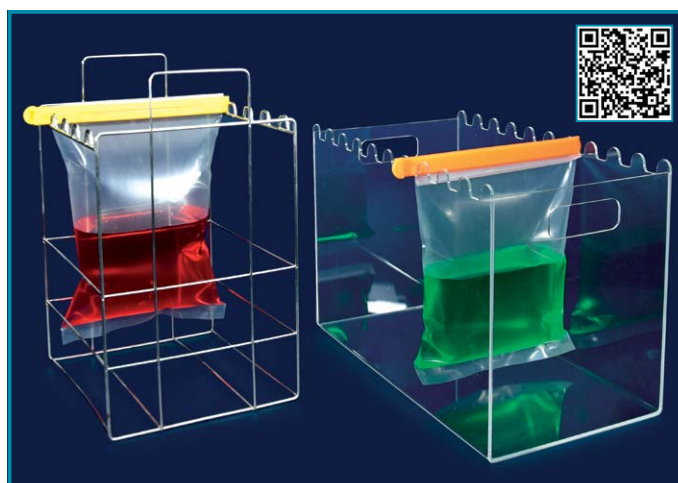

BAG LATCHES

➤ **BAG LATCHES**: Manufactured from a special grade of polypropylene for quick closing of the bags. Practical closing system guarantees perfect and tight closure of the bags.

➤ Color coded in 4 different colors for fast and easy identification.

| catalogue number | pack quantity |
|------------------|---------------|
| 039.35.200 | set of 4 |





ISOLAB
Laborgeräte GmbH



*distillation & filtration
separation
sample preparation*



distillation & filtration & separation & sample preparation

GROUND JOINTS - "socket"



- ▶ Manufactured from heat resistant, durable borosilicate glass according to DIN 12249 standard with 120 mm length.
- ▶ Excellent grinding quality prevents airleaks and liquid leakage.

| catalogue number | joint NS size | pack quantity |
|------------------|---------------|---------------|
| 063.01.010 | 10/19 | 1 piece |
| 063.01.012 | 12/21 | 1 piece |
| 063.01.014 | 14/23 | 1 piece |
| 063.01.019 | 19/26 | 1 piece |
| 063.01.024 | 24/29 | 1 piece |
| 063.01.029 | 29/32 | 1 piece |
| 063.01.034 | 34/35 | 1 piece |
| 063.01.045 | 45/40 | 1 piece |

GROUND JOINTS - "cone"



- ▶ Manufactured from heat resistant, durable borosilicate glass according to DIN 12249 standard with 120 mm length.
- ▶ Excellent grinding quality prevents airleaks and liquid leakage.

| catalogue number | joint NS size | pack quantity |
|------------------|---------------|---------------|
| 063.02.010 | 10/19 | 1 piece |
| 063.02.012 | 12/21 | 1 piece |
| 063.02.014 | 14/23 | 1 piece |
| 063.02.019 | 19/26 | 1 piece |
| 063.02.024 | 24/29 | 1 piece |
| 063.02.029 | 29/32 | 1 piece |
| 063.02.034 | 34/35 | 1 piece |
| 063.02.045 | 45/40 | 1 piece |

ADAPTERS - "expansion"



- ▶ Manufactured from heat resistant, durable borosilicate glass according to DIN 12257 standard with socket size larger than cone size.

| catalogue number | cone NS | socket NS | pack quantity |
|------------------|---------|-----------|---------------|
| 064.11.001 | 12/21 | 14/23 | 1 pc. |
| 064.11.002 | 14/23 | 19/26 | 1 pc. |
| 064.11.003 | 14/23 | 24/29 | 1 pc. |
| 064.11.004 | 19/26 | 24/29 | 1 pc. |
| 064.11.005 | 14/23 | 29/32 | 1 pc. |
| 064.11.006 | 19/26 | 29/32 | 1 pc. |
| 064.11.007 | 24/29 | 29/32 | 1 pc. |
| 064.11.008 | 19/26 | 34/35 | 1 pc. |
| 064.11.009 | 24/29 | 34/35 | 1 pc. |
| 064.11.010 | 29/32 | 34/35 | 1 pc. |
| 064.11.011 | 24/29 | 45/40 | 1 pc. |
| 064.11.012 | 29/32 | 45/40 | 1 pc. |

ADAPTERS - "reduction"



- ▶ Manufactured from heat resistant, durable borosilicate glass according to DIN 12257 standard with socket size smaller than cone size.

| catalogue number | cone NS | socket NS | pack quantity |
|------------------|---------|-----------|---------------|
| 064.12.001 | 14/23 | 12/21 | 1 pc. |
| 064.12.002 | 19/26 | 14/23 | 1 pc. |
| 064.12.003 | 24/29 | 14/23 | 1 pc. |
| 064.12.004 | 29/32 | 14/23 | 1 pc. |
| 064.12.005 | 24/29 | 19/26 | 1 pc. |
| 064.12.006 | 29/32 | 19/26 | 1 pc. |
| 064.12.007 | 34/35 | 19/26 | 1 pc. |
| 064.12.008 | 29/32 | 24/29 | 1 pc. |
| 064.12.009 | 34/35 | 24/29 | 1 pc. |
| 064.12.010 | 45/40 | 24/29 | 1 pc. |
| 064.12.011 | 34/35 | 29/32 | 1 pc. |
| 064.12.012 | 45/40 | 29/32 | 1 pc. |

ADAPTERS - "with screw thread"



- ▶ Manufactured from heat resistant, durable borosilicate glass according to DIN 12257 standard.
- ▶ Excellent grinding quality prevents airleaks and liquid leakage.
- ▶ Different thread sizes offer multiple tubing connection options.

| catalogue number | joint NS size | neck thread | pack quantity |
|------------------|---------------|-------------|---------------|
| 065.19.141 | 14/23 | GL 14 | 1 pc. |
| 065.19.142 | 14/23 | GL 18 | 1 pc. |
| 065.19.291 | 29/32 | GL 14 | 1 pc. |
| 065.19.292 | 29/32 | GL 18 | 1 pc. |
| 065.19.293 | 29/32 | GL 25 | 1 pc. |

ADAPTERS - "with screw thread & cap"



- ▶ Manufactured from heat resistant, durable borosilicate glass according to DIN 12257 standard.
- ▶ Excellent grinding quality prevents airleaks and liquid leakage.
- ▶ Supplied with a screw cap with hole featured with silicone sealing.
- ▶ Provides easy adjustment of thermometer height position.

| catalogue number | joint NS size | neck thread | pack quantity |
|------------------|---------------|-------------|---------------|
| 065.21.014 | 14/23 | GL 14 | 1 pc. |
| 065.21.029 | 29/32 | GL 14 | 1 pc. |

distillation & filtration & separation & sample preparation

ADAPTERS - "straight"



- Manufactured from heat resistant, durable borosilicate glass featured with a straight tubing adapter.
- Excellently grinded joint prevents airleaks and leakage.
- Tubing adapter fits tubings with 6-10 mm diameter.

| catalogue number | joint NS size | pack quantity |
|------------------|---------------|---------------|
| 065.26.014 | 14/23 | 1 piece |
| 065.26.029 | 29/32 | 1 piece |

ADAPTERS - "straight" - "with stopcock"



- Manufactured from borosilicate 3.3 with a straight adapter and a PTFE stopcock.
- Excellently grinded joint prevents airleaks and leakage.
- Tubing adapter fits tubings with 6-10 mm diameter.

| catalogue number | joint NS size | pack quantity |
|------------------|---------------|---------------|
| 065.28.014 | 14/23 | 1 piece |
| 065.28.029 | 29/32 | 1 piece |

ADAPTERS - "bend"



- Manufactured from heat resistant, durable borosilicate glass featured with a 90° angle bend tubing adapter.
- Excellently grinded joint prevents airleaks and leakage.
- Tubing adapter fits tubings with 6-10 mm diameter.

| catalogue number | joint NS size | pack quantity |
|------------------|---------------|---------------|
| 065.27.014 | 14/23 | 1 piece |
| 065.27.029 | 29/32 | 1 piece |

ADAPTERS - "bend" - "with stopcock"



- Manufactured from heat resistant, durable borosilicate glass with a 90° bend tubing adapter and a PTFE stopcock.
- Excellently grinded joint prevents airleaks and leakage.
- Tubing adapter fits tubings with 6-10 mm diameter.

| catalogue number | joint NS size | pack quantity |
|------------------|---------------|---------------|
| 065.29.014 | 14/23 | 1 piece |
| 065.29.029 | 29/32 | 1 piece |

ADAPTERS - "straight"



- Manufactured from heat resistant, durable borosilicate glass featured with a straight tubing adapter.
- Excellently grinded joint prevents airleaks and leakage.
- Tubing adapter fits tubings with 6-10 mm diameter.

| catalogue number | joint NS size | pack quantity |
|------------------|---------------|---------------|
| 065.22.014 | 14/23 | 1 piece |
| 065.22.029 | 29/32 | 1 piece |

ADAPTERS - "straight" - "with stopcock"



- Manufactured from heat resistant, durable borosilicate glass featured with a straight tubing adapter and a PTFE stopcock.
- Excellently grinded joint prevents airleaks and leakage.
- Tubing adapter fits tubings with 6-10 mm diameter.

| catalogue number | joint NS size | pack quantity |
|------------------|---------------|---------------|
| 065.24.014 | 14/23 | 1 piece |
| 065.24.029 | 29/32 | 1 piece |

ADAPTERS - "bend"



- Manufactured from heat resistant, durable borosilicate glass featured with a 90° angle bend tubing adapter.
- Excellently grinded joint prevents airleaks and leakage.
- Tubing adapter fits tubings with 6-10 mm diameter.

| catalogue number | joint NS size | pack quantity |
|------------------|---------------|---------------|
| 065.23.014 | 14/23 | 1 piece |
| 065.23.029 | 29/32 | 1 piece |

ADAPTERS - "bend" - "with stopcock"



- Manufactured from heat resistant, durable borosilicate glass with a 90° angle bend tubing adapter and a PTFE stopcock.
- Excellently grinded joint prevents airleaks and leakage.
- Tubing adapter fits tubings with 6-10 mm diameter.

| catalogue number | joint NS size | pack quantity |
|------------------|---------------|---------------|
| 065.25.014 | 14/23 | 1 piece |
| 065.25.029 | 29/32 | 1 piece |

distillation & filtration & separation & sample preparation

ADAPTERS - "bend" - "75° angle"



► Manufactured from heat resistant, durable borosilicate glass 75° angle bend and featured with two cones on both ends.

► Excellently grinded cones prevent airleaks and liquid leakage.

| catalogue number | joint NS size | pack quantity |
|------------------|---------------|---------------|
| 065.37.014 | 14/23 | 1 piece |
| 065.37.029 | 29/32 | 1 piece |

ADAPTERS - "bend" - "90° angle"



► Manufactured from heat resistant, durable borosilicate glass 90° angle bend and featured with two cones on both ends.

► Excellently grinded cones prevent airleaks and liquid leakage.

| catalogue number | joint NS size | pack quantity |
|------------------|---------------|---------------|
| 065.38.014 | 14/23 | 1 piece |
| 065.38.029 | 29/32 | 1 piece |

ADAPTERS - "2 necks" - "45° upwards angled"



► Manufactured from heat resistant, durable borosilicate glass featured with a 45° upwards angled socket.

► Excellently grinded joints prevent airleaks and liquid leakage.

| catalogue number | socket NS size | cone NS size | angled socket NS size | pack quantity |
|------------------|----------------|--------------|-----------------------|---------------|
| 065.42.001 | NS 14/23 | NS 14/23 | NS 14/23 | 1 piece |
| 065.42.002 | NS 19/26 | NS 19/26 | NS 19/26 | 1 piece |
| 065.42.003 | NS 29/32 | NS 29/32 | NS 14/23 | 1 piece |
| 065.42.004 | NS 29/32 | NS 29/32 | NS 29/32 | 1 piece |

ADAPTERS - "2 necks" - "75° downwards angled"



► Manufactured from heat resistant, durable borosilicate glass featured with a 75° downwards angled socket.

► Excellently grinded joints prevent airleaks and liquid leakage.

| catalogue number | socket NS size | cone NS size | angled socket NS size | pack quantity |
|------------------|----------------|--------------|-----------------------|---------------|
| 065.18.001 | NS 14/23 | NS 14/23 | NS 14/23 | 1 piece |
| 065.18.002 | NS 19/26 | NS 19/26 | NS 19/26 | 1 piece |
| 065.18.003 | NS 29/32 | NS 29/32 | NS 14/23 | 1 piece |
| 065.18.004 | NS 29/32 | NS 29/32 | NS 29/32 | 1 piece |

ADAPTERS - "2 necks" - "parallel"



► Manufactured from heat resistant, durable borosilicate glass featured with a parallel socket.

► Excellently grinded joints prevent airleaks and liquid leakage.

| catalogue number | socket NS size | cone NS size | parallel socket NS size | pack quantity |
|------------------|----------------|--------------|-------------------------|---------------|
| 065.43.001 | NS 14/23 | NS 14/23 | NS 14/23 | 1 piece |
| 065.43.002 | NS 19/26 | NS 19/26 | NS 19/26 | 1 piece |
| 065.43.003 | NS 24/29 | NS 19/26 | NS 19/26 | 1 piece |
| 065.43.004 | NS 24/29 | NS 24/29 | NS 24/29 | 1 piece |
| 065.43.005 | NS 29/32 | NS 14/23 | NS 14/23 | 1 piece |
| 065.43.006 | NS 29/32 | NS 29/32 | NS 29/32 | 1 piece |

ADAPTERS - "3 necks" - "angled & parallel"



► Manufactured from heat resistant, durable borosilicate glass featured with one parallel and one angled socket.

► Excellently grinded joints prevent airleaks and liquid leakage.

| catalogue number | socket NS size | cone NS size | parallel socket NS size | pack quantity |
|------------------|----------------|--------------|-------------------------|---------------|
| 065.44.001 | NS 14/23 | NS 14/23 | NS 14/23 | 1 piece |
| 065.44.002 | NS 19/26 | NS 24/29 | NS 19/26 | 1 piece |
| 065.44.003 | NS 19/26 | NS 29/32 | NS 19/26 | 1 piece |
| 065.44.004 | NS 24/29 | NS 24/29 | NS 24/29 | 1 piece |
| 065.44.005 | NS 29/32 | NS 29/32 | NS 29/32 | 1 piece |

distillation & filtration & separation & sample preparation

DISTILLING HEADS



▶ Manufactured from heat resistant, durable borosilicate glass according to DIN 12594 standard featured with a 75° downwards angled cone.

▶ NS 14/23 socket is designed to be used with distillation thermometers.

▶ Excellently grinded joints prevent airleaks and liquid leakage.

| catalogue number | socket NS size | cone NS size | angled cone NS size | pack quantity |
|------------------|----------------|--------------|---------------------|---------------|
| 065.45.001 | NS 14/23 | NS 14/23 | NS 14/23 | 1 piece |
| 065.45.002 | NS 14/23 | NS 19/26 | NS 19/26 | 1 piece |
| 065.45.005 | NS 14/23 | NS 29/32 | NS 29/32 | 1 piece |

DISTILLING HEADS - "Claisen"



▶ Manufactured from heat resistant, durable borosilicate glass according to DIN 12594 standard featured with a 75° downwards angled cone.

▶ Two parallel NS 14/23 sockets are designed to be used with distillation thermometers.

▶ Excellently grinded joints prevent airleaks and liquid leakage.

| catalogue number | socket NS size | cone NS size | angled cone NS size | pack quantity |
|------------------|----------------|--------------|---------------------|---------------|
| 065.46.001 | NS 14/23 | NS 14/23 | NS 14/23 | 1 piece |
| 065.46.002 | NS 14/23 | NS 19/26 | NS 19/26 | 1 piece |
| 065.46.005 | NS 14/23 | NS 29/32 | NS 14/23 | 1 piece |
| 065.46.006 | NS 14/23 | NS 29/32 | NS 29/32 | 1 piece |

SPLASH HEADS - "straight"



▶ Manufactured from heat resistant, durable borosilicate glass for separation of drops. Advised to be placed directly on top of the distillation flasks.

▶ Excellently grinded joints prevent airleaks and liquid leakage.

| catalogue number | cone NS | socket NS | pack quantity |
|------------------|---------|-----------|---------------|
| 065.47.001 | 14/23 | 14/23 | 1 piece |
| 065.47.003 | 29/32 | 29/32 | 1 piece |

SPLASH HEADS - "bend"



▶ Manufactured from heat resistant, durable borosilicate glass 75° angled bend for separation of drops. Advised to be placed directly on top of the distillation flasks.

▶ Excellently grinded joints prevent airleaks and liquid leakage.

| catalogue number | cone NS | socket NS | pack quantity |
|------------------|---------|-----------|---------------|
| 065.48.001 | 14/23 | 14/23 | 1 piece |
| 065.48.005 | 29/32 | 29/32 | 1 piece |

ADAPTERS - "delivery" - "straight"



▶ Manufactured from heat resistant, durable borosilicate glass according to DIN 12594 standard with a cone with drain tip.

▶ Featured with a straight socket and a vacuum connecting adapter.

▶ Excellently grinded joints prevent airleaks and liquid leakage.

| catalogue number | cone NS | socket NS | pack quantity |
|------------------|---------|-----------|---------------|
| 065.34.014 | 14/23 | 14/23 | 1 piece |
| 065.34.029 | 29/32 | 29/32 | 1 piece |

ADAPTERS - "with stopcock"



▶ Manufactured from heat resistant, durable borosilicate glass according to DIN 12594 standard with a socket with drain tip.

▶ Featured with a straight socket and cone and a PTFE stopcock.

▶ Excellently grinded joints prevent airleaks and liquid leakage.

| catalogue number | cone NS | socket NS | pack quantity |
|------------------|---------|-----------|---------------|
| 065.41.014 | 14/23 | 14/23 | 1 piece |
| 065.41.019 | 19/26 | 19/26 | 1 piece |
| 065.41.024 | 24/29 | 24/29 | 1 piece |
| 065.41.029 | 29/32 | 29/32 | 1 piece |

distillation & filtration & separation & sample preparation

DISTILLING LINKS



► Manufactured from heat resistant, durable borosilicate glass without condenser with two parallel cones.

► Excellently grinded joints prevent airleaks and liquid leakage.

| catalogue number | cone NS size | cone NS size | pack quantity |
|------------------|--------------|--------------|---------------|
| 065.52.014 | NS 14/23 | NS 14/23 | 1 piece |
| 065.52.029 | NS 29/32 | NS 29/32 | 1 piece |

DISTILLING LINKS - "with splash head"



► Manufactured from heat resistant, durable borosilicate glass with a splash head and with two parallel cones.

► Excellently grinded joints prevent airleaks and liquid leakage.

| catalogue number | cone NS size | cone NS size | pack quantity |
|------------------|--------------|--------------|---------------|
| 065.54.014 | NS 14/23 | NS 14/23 | 1 piece |
| 065.54.029 | NS 29/32 | NS 29/32 | 1 piece |

DISTILLING LINKS - "with socket"



► Manufactured from heat resistant, durable borosilicate glass without condenser with two parallel cones. NS 14/23 socket is designed to be used with distillation thermometers.

► Excellently grinded joints prevent airleaks and liquid leakage.

| catalogue number | cone NS size | cone NS size | socket NS size | pack quantity |
|------------------|--------------|--------------|----------------|---------------|
| 065.53.014 | NS 14/23 | NS 14/23 | NS 14/23 | 1 piece |
| 065.53.029 | NS 29/32 | NS 29/32 | NS 14/23 | 1 piece |

DISTILLING LINKS - "with condenser"



► Manufactured from heat resistant, durable borosilicate glass with a liebig condenser with a NS 14/23 socket is designed to be used with distillation thermometers.

► Excellently grinded joints prevent airleaks and liquid leakage.

| catalogue number | cone NS size | socket NS size | condenser length | pack quantity |
|------------------|--------------|----------------|------------------|---------------|
| 065.55.001 | NS 14/23 | NS 14/23 | 160 mm | 1 piece |
| 065.55.002 | NS 14/23 | NS 14/23 | 250 mm | 1 piece |
| 065.55.003 | NS 29/32 | NS 14/23 | 250 mm | 1 piece |
| 065.55.004 | NS 29/32 | NS 14/23 | 400 mm | 1 piece |

DISTILLING LINKS - "condenser & adapter"



► Manufactured from heat resistant, durable borosilicate glass with a liebig condenser with a NS 14/23 socket is designed to be used with distillation thermometers. Featured with a vacuum connecting adapter.

► Excellently grinded joints prevent airleaks and liquid leakage.

| catalogue number | cone NS size | socket NS size | condenser length | pack quantity |
|------------------|--------------|----------------|------------------|---------------|
| 065.56.001 | NS 14/23 | NS 14/23 | 160 mm | 1 piece |
| 065.56.002 | NS 14/23 | NS 14/23 | 250 mm | 1 piece |
| 065.56.003 | NS 29/32 | NS 14/23 | 250 mm | 1 piece |
| 065.56.004 | NS 29/32 | NS 14/23 | 400 mm | 1 piece |

distillation & filtration & separation & sample preparation

DISTILLING LINKS - "with condenser" - "Claisen head"

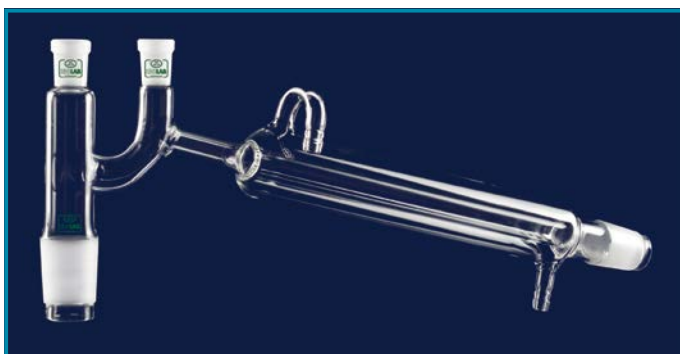

► Manufactured from heat resistant, durable borosilicate glass with a liebig condenser with two NS 14/23 socket is designed to be used with distillation thermometers.

► Excellently grinded joints prevent airleaks and liquid leakage.

| catalogue number | cone NS size | socket NS size | condenser length | pack quantity |
|------------------|--------------|----------------|------------------|---------------|
| 065.57.001 | NS 14/23 | NS 14/23 | 160 mm | 1 piece |
| 065.57.002 | NS 14/23 | NS 14/23 | 250 mm | 1 piece |
| 065.57.003 | NS 29/32 | NS 14/23 | 250 mm | 1 piece |
| 065.57.004 | NS 29/32 | NS 14/23 | 400 mm | 1 piece |

DISTILLING LINKS - "with condenser & vacuum adapter" - "Claisen head"



► Manufactured from heat resistant, durable borosilicate glass with a liebig condenser with two NS 14/23 socket is designed to be used with distillation thermometers. Featured with a vacuum connecting adapter.

► Excellently grinded joints prevent airleaks and liquid leakage.

| catalogue number | cone NS size | socket NS size | condenser length | pack quantity |
|------------------|--------------|----------------|------------------|---------------|
| 065.58.001 | NS 14/23 | NS 14/23 | 160 mm | 1 piece |
| 065.58.002 | NS 14/23 | NS 14/23 | 250 mm | 1 piece |
| 065.58.003 | NS 29/32 | NS 14/23 | 250 mm | 1 piece |
| 065.58.004 | NS 29/32 | NS 14/23 | 400 mm | 1 piece |

ADAPTERS - "PTFE" - "flexible"



► Manufactured from chemically inert PTFE with excellent chemical resistance, high mechanical strength and high temperature resistance between -200°C to +260°C.

► Unique flexible body form guarantees 90° angular connections of NS joints and provides corrections of misalignment in glassware assemblies.

► Extra smooth interior finish guarantees high vacuum sealing performance without a need of any lubricant.

| catalogue number | socket NS size | cone NS size | pack quantity |
|------------------|----------------|--------------|---------------|
| 065.36.014 | NS 14/23 | NS 14/23 | 1 piece |
| 065.36.019 | NS 19/26 | NS 19/26 | 1 piece |
| 065.36.024 | NS 24/29 | NS 24/29 | 1 piece |
| 065.36.029 | NS 29/32 | NS 29/32 | 1 piece |

GLASS BEADS



► Manufactured from borosilicate glass.

► They offer practical solutions specially for distillation applications with their different diameters.

| catalogue number | diameter (mm) | pack quantity |
|------------------|---------------|---------------|
| 030.60.003 | 3,0 - 3,5 | 1 kg |
| 030.60.004 | 3,5 - 4,0 | 1 kg |
| 030.60.005 | 4,0 - 5,0 | 1 kg |
| 030.60.006 | 5,0 - 6,0 | 1 kg |

distillation & filtration & separation & sample preparation

ADAPTERS - "delivery" - "bend" - "short"



- Manufactured from heat resistant, durable borosilicate glass with 65 mm length.
- Featured with a 105° angled bend socket.
- Excellently grinded joint prevents airleaks and liquid leakage.

| catalogue number | socket NS size | pack quantity |
|------------------|----------------|---------------|
| 065.30.014 | 14/23 | 1 piece |
| 065.30.029 | 29/32 | 1 piece |

ADAPTERS - "delivery" - "bend" - "long"



- Manufactured from heat resistant, durable borosilicate glass with 200 mm length.
- Featured with a 105° angled bend socket.
- Excellently grinded joint prevents airleaks and liquid leakage.

| catalogue number | socket NS size | pack quantity |
|------------------|----------------|---------------|
| 065.31.014 | 14/23 | 1 piece |
| 065.31.029 | 29/32 | 1 piece |

ADAPTERS - "delivery" - "bend"



- Manufactured from heat resistant, durable borosilicate glass featured with a cone and a socket with drain tip.
- Featured with a 105° angled bend socket.
- Excellently grinded joints prevent airleaks and liquid leakage.

| catalogue number | cone NS | socket NS | pack quantity |
|------------------|---------|-----------|---------------|
| 065.32.014 | 14/23 | 14/23 | 1 piece |
| 065.32.029 | 29/32 | 29/32 | 1 piece |

ADAPTERS - "delivery" - "bend" - "with ventilation"



- Manufactured from heat resistant, durable borosilicate glass featured with a cone and a socket with drain tip.
- Featured with a 105° angled bend socket and with ventilation arm useful to be used with highly boiling liquids.
- Excellently grinded joints prevent airleaks and liquid leakage.

| catalogue number | cone NS | socket NS | pack quantity |
|------------------|---------|-----------|---------------|
| 065.33.014 | 14/23 | 14/23 | 1 piece |
| 065.33.029 | 29/32 | 29/32 | 1 piece |

ADAPTERS - "receiving" - "straight"



- Manufactured from heat resistant, durable borosilicate glass according to DIN 12594 standard with a cone with drain tip.
- Featured with a straight cone and a vacuum connecting adapter.
- Excellently grinded joints prevent airleaks and liquid leakage.

| catalogue number | cone NS | socket NS | pack quantity |
|------------------|---------|-----------|---------------|
| 065.39.014 | 14/23 | 14/23 | 1 piece |
| 065.39.029 | 29/32 | 29/32 | 1 piece |

ADAPTERS - "receiving" - "bend"



- Manufactured from heat resistant, durable borosilicate glass according to DIN 12594 standard with a cone with drain tip.
- Featured with a bend cone and a vacuum connecting adapter.
- Excellently grinded joints prevent airleaks and liquid leakage.

| catalogue number | cone NS | socket NS | pack quantity |
|------------------|---------|-----------|---------------|
| 065.40.014 | 14/23 | 14/23 | 1 piece |
| 065.40.029 | 29/32 | 29/32 | 1 piece |

distillation & filtration & separation & sample preparation

DRYING TUBES - "bend"



- ▶ Manufactured from heat resistant, durable borosilicate glass according to DIN 12610 standard with a ball and connection tube.

| catalogue number | pack quantity |
|------------------|---------------|
| 065.60.100 | 1 piece |
| 065.60.150 | 1 piece |

DRYING TUBES - "U form"



- ▶ Manufactured from heat resistant, durable borosilicate glass with a U form.

| catalogue number | pack quantity |
|------------------|---------------|
| 065.62.100 | 1 piece |
| 065.62.130 | 1 piece |
| 065.62.180 | 1 piece |

DRYING TUBES - "U form" - "with stopcock"



- ▶ Manufactured from heat resistant, durable borosilicate glass according to DIN 12610 standard with a U form and featured with a stopcock.

| catalogue number | pack quantity |
|------------------|---------------|
| 065.63.100 | 1 piece |
| 065.63.130 | 1 piece |
| 065.63.180 | 1 piece |

BOTTLES - "gas washing"



- ▶ Manufactured from borosilicate 3.3 with thick walls with NS 29/32 neck size.

- ▶ Supplied without the bottle heads.

| catalogue number | bottle volume | pack quantity |
|------------------|---------------|---------------|
| 065.66.125 | 125 ml | 1 piece |
| 065.66.250 | 250 ml | 1 piece |
| 065.66.500 | 500 ml | 1 piece |
| 065.66.901 | 1000 ml | 1 piece |

BOTTLE HEAD - "glass side arm" - "without disc"



- ▶ Manufactured from heat resistant, durable borosilicate glass without sintered glass support.

- ▶ Featured with a glass side arm.

| catalogue number | pack quantity |
|------------------|---------------|
| 065.67.001 | 1 piece |

BOTTLE HEAD - "glass side arm" - "with disc"



- ▶ Manufactured from heat resistant, durable borosilicate glass with sintered glass support.

- ▶ Featured with a glass side arm.

- ▶ Sintered glass disc with porosity 1 for efficient gas dispensing.

| catalogue number | pack quantity |
|------------------|---------------|
| 065.67.011 | 1 piece |

BOTTLE HEAD - "PP side arm" - "without disc"



- ▶ Manufactured from heat resistant, durable borosilicate glass without sintered glass support.

- ▶ Featured with with GL 14 screw thread polypropylene side arm which can easily connected or disconnected preventing accidental breakage.

| catalogue number | pack quantity |
|------------------|---------------|
| 065.67.002 | 1 piece |

BOTTLE HEAD - "PP side arm" - "with disc"



- ▶ Manufactured from heat resistant, durable borosilicate glass with sintered glass support.

- ▶ Sintered glass disc with porosity 1 enables efficient gas dispensing

- ▶ Featured with with GL 14 screw thread polypropylene side arms.

| catalogue number | pack quantity |
|------------------|---------------|
| 065.67.022 | 1 piece |

distillation & filtration & separation & sample preparation

CHEMISTRY SET

- Set consists of 16 pieces various small size glassware with NS 14/23 joints.
- Allows multi micro experiments under vacuum or atmospheric pressure.
- Supplied in a sturdy plastic case featured with foam inserts. Foam inserts prevent breakage and allow organised storing of the contents.
- Product descriptions of the chemistry set are shown at below list.

| catalogue number | pack quantity |
|------------------|---------------|
| 067.30.001 | 1 piece |



| item photo code | product descriptions | pack quantity |
|-----------------|---|---------------|
| 1 | filter funnel | 1 piece |
| 2 | receiver adapter - short stem | 1 piece |
| 3 | stillhead with screwcap adapter | 1 piece |
| 4 | receiver adapter - with vent | 1 piece |
| 5 | pear shape flask with three necks - 25 ml | 1 piece |
| 6 | erlenmeyer flask - 25 ml | 1 piece |
| 7 | seperating funnel - with PTFE key - 30 ml | 1 piece |
| 8 | vigreux fractionating column | 1 piece |

| item photo code | product descriptions | pack quantity |
|-----------------|------------------------------------|---------------|
| 9 | measuring cylinder - 10 ml | 1 piece |
| 10 | beaker - low form - 25 ml | 1 piece |
| 11 | liebig condenser | 1 piece |
| 12 | flat bottom flask - 10 ml | 1 piece |
| 13 | keck clip | 1 piece |
| 14 | pressure equalising funnel - 10 ml | 1 piece |
| 15 | hexagonal stoppers | 2 pieces |
| 16 | microscale chemistry case | 1 piece |

WATER ESTIMATOR



- Manufactured from borosilicate 3.3 for determination of water with xylol method.
- System consists of a 500 ml flask with NS 29/32 joint, a liebig condenser of 400 mm length and a measuring tube with PTFE stopcock.

| catalogue number | pack quantity |
|------------------|---------------|
| 065.70.001 | 1 piece |

ARSENIC ESTIMATOR



- Manufactured from borosilicate 3.3 for determination of arsenic and antimony content.
- System consists of a 100 ml erlenmeyer with NS 29/32 joint and an absorption tube attached to erlenmeyer.

| catalogue number | pack quantity |
|------------------|---------------|
| 065.71.001 | 1 piece |

distillation & filtration & separation & sample preparation



CLIPS - "for NS joints"

- Manufactured from POM with excellent chemical resistance and high mechanical strength.
- With their flexible jaws, they guarantee absolute leak-proof, tight connection of two NS joints.

| catalogue number | color | NS size | pack quantity |
|------------------|--------|----------|---------------|
| 063.04.010 | black | NS 10/19 | 1 piece |
| 063.04.012 | purple | NS 12/21 | 1 piece |
| 063.04.014 | yellow | NS 14/23 | 1 piece |
| 063.04.019 | blue | NS 19/26 | 1 piece |
| 063.04.024 | green | NS 24/29 | 1 piece |
| 063.04.029 | red | NS 29/32 | 1 piece |
| 063.04.034 | orange | NS 34/35 | 1 piece |
| 063.04.045 | brown | NS 45/40 | 1 piece |



JOINT GREASE "standard vacuum"

- Ideal for lubricating and leak-proof sealing of all types of joints, metal and plastic connectors and stopcocks.
- Recommended to be used under standard vacuum conditions.
- Guarantees excellent chemical and temperature resistance between -40°C to $+300^{\circ}\text{C}$.
- Non-solidifying during use. Easily washable due to water soluble characteristic.
- Best results can be achieved by application of a thin layer.
- Supplied in a tube of 30 gram lubricant weight.

| catalogue number | grease color | pack quantity |
|------------------|--------------|---------------|
| 063.17.001 | clear | 1 piece |



JOINT GREASE "high vacuum"

- Ideal for lubricating and leak-proof sealing of all types of joints, metal and plastic connectors and stopcocks.
- Recommended to be used under high vacuum conditions.
- Guarantees excellent chemical and temperature resistance between -40°C to $+320^{\circ}\text{C}$.
- Non-solidifying during use. Easily washable due to water soluble characteristic.
- Best results can be achieved by application of a thin layer.
- Supplied in a tube of 30 gram lubricant weight.

| catalogue number | grease color | pack quantity |
|------------------|--------------|---------------|
| 063.17.002 | brown | 1 piece |

JOINT SLEEVES - "PTFE"



- Manufactured from chemically inert PTFE with excellent chemical resistance, high mechanical strength and high temperature resistance between -200°C to $+260^{\circ}\text{C}$.
- Unique flexible body form guarantees leak-proof connections of NS joints with high vacuum performance.
- Extra smooth interior finish guarantees high vacuum sealing performance without a need of any lubricant.



| catalogue number | NS size | pack quantity |
|------------------|----------|---------------|
| 063.14.014 | NS 14/23 | 1 piece |
| 063.14.019 | NS 19/26 | 1 piece |
| 063.14.024 | NS 24/29 | 1 piece |
| 063.14.029 | NS 29/32 | 1 piece |
| 063.14.034 | NS 34/35 | 1 piece |
| 063.14.045 | NS 45/40 | 1 piece |



SEALING TAPE - "PTFE"

- Manufactured from chemically inert PTFE with excellent chemical resistance, high mechanical strength and high temperature resistance between -200°C to $+260^{\circ}\text{C}$.
- Stretches, conforms and perfectly seals all joints, connectors, stopcocks with leak-proof tightness.

| catalogue number | tape width | tape length | pack quantity |
|------------------|------------|-------------|---------------|
| 058.06.001 | 12 mm | 10 mt | 1 piece |

distillation & filtration & separation & sample preparation

CONDENSERS - "liebigh" - "glass side arm"

► Manufactured from heat resistant, durable borosilicate glass according to DIN 12576 standard. Featured with glass side arms fitting 8-9 mm bore size tubings. Thick wall, and reinforced rim prevent breakage during washing and transportation.

| catalogue number | effective length | joint NS size | pack quantity |
|------------------|------------------|---------------|---------------|
| 033.11.160 | 160 mm | NS 14/23 | 1 piece |
| 033.11.250 | 250 mm | NS 14/23 | 1 piece |
| 033.11.252 | 250 mm | NS 24/29 | 1 piece |
| 033.11.253 | 250 mm | NS 29/32 | 1 piece |
| 033.11.400 | 400 mm | NS 14/23 | 1 piece |
| 033.11.402 | 400 mm | NS 24/29 | 1 piece |
| 033.11.403 | 400 mm | NS 29/32 | 1 piece |

CONDENSERS - "liebigh" - "P.P side arm"

► Manufactured from heat resistant, durable borosilicate glass according to DIN 12576 standard. Featured with GL 14 screw thread polypropylene side arms fitting 8-9 mm bore size tubings. Side arms can be easily connected or disconnected to the main body preventing accidental breakage.

| catalogue number | effective length | joint NS size | pack quantity |
|------------------|------------------|---------------|---------------|
| 033.12.160 | 160 mm | NS 14/23 | 1 piece |
| 033.12.250 | 250 mm | NS 14/23 | 1 piece |
| 033.12.252 | 250 mm | NS 24/29 | 1 piece |
| 033.12.253 | 250 mm | NS 29/32 | 1 piece |
| 033.12.400 | 400 mm | NS 14/23 | 1 piece |
| 033.12.402 | 400 mm | NS 24/29 | 1 piece |
| 033.12.403 | 400 mm | NS 29/32 | 1 piece |

CONDENSERS - "allihn" - "glass side arm"

► Manufactured from heat resistant, durable borosilicate glass according to DIN 12581 standard. Featured with glass side arms fitting 8-9 mm bore size tubings. Thick wall and reinforced rim prevent breakage during washing and transportation.

| catalogue number | effective length | joint NS size | pack quantity |
|------------------|------------------|---------------|---------------|
| 033.13.160 | 160 mm | NS 14/23 | 1 piece |
| 033.13.250 | 250 mm | NS 14/23 | 1 piece |
| 033.13.252 | 250 mm | NS 24/29 | 1 piece |
| 033.13.253 | 250 mm | NS 29/32 | 1 piece |
| 033.13.400 | 400 mm | NS 14/23 | 1 piece |
| 033.13.402 | 400 mm | NS 24/29 | 1 piece |
| 033.13.403 | 400 mm | NS 29/32 | 1 piece |

CONDENSERS - "allihn" - "P.P side arm"

► Manufactured from heat resistant, durable borosilicate glass according to DIN 12581 standard. Featured with GL 14 screw thread polypropylene side arms fitting 8-9 mm bore size tubings. Side arms can be easily connected or disconnected to the main body preventing accidental breakage.

| catalogue number | effective length | joint NS size | pack quantity |
|------------------|------------------|---------------|---------------|
| 033.14.160 | 160 mm | NS 14/23 | 1 piece |
| 033.14.250 | 250 mm | NS 14/23 | 1 piece |
| 033.14.252 | 250 mm | NS 24/29 | 1 piece |
| 033.14.253 | 250 mm | NS 29/32 | 1 piece |
| 033.14.400 | 400 mm | NS 14/23 | 1 piece |
| 033.14.402 | 400 mm | NS 24/29 | 1 piece |
| 033.14.403 | 400 mm | NS 29/32 | 1 piece |

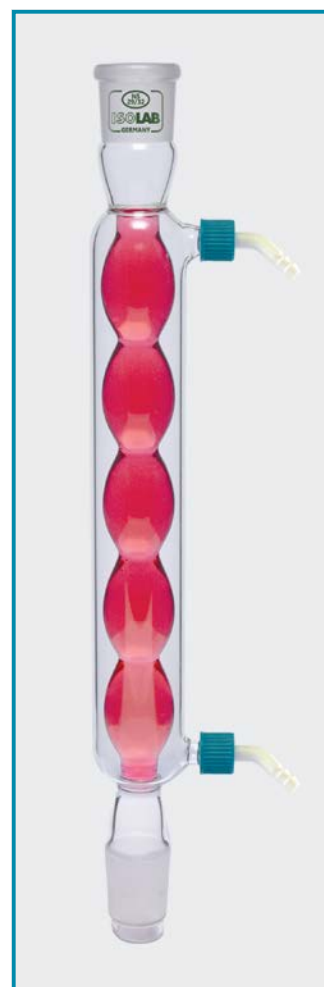
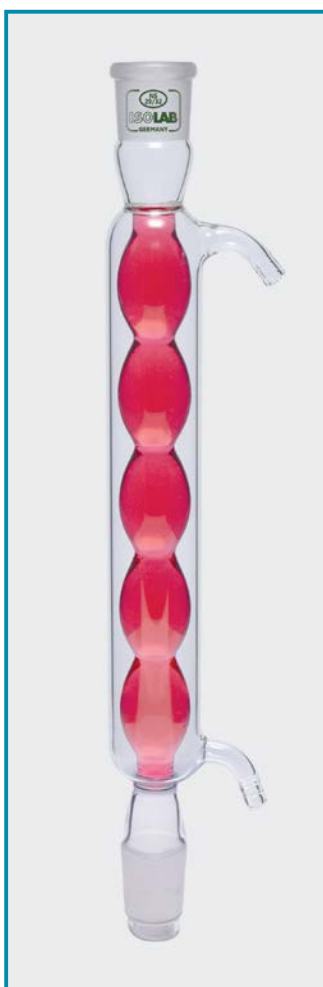
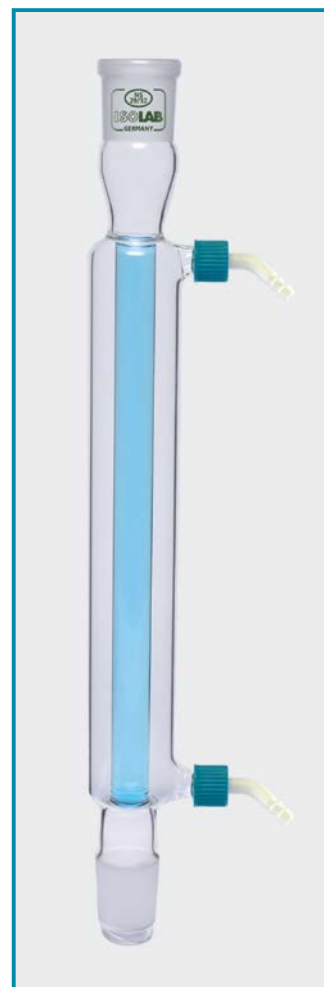
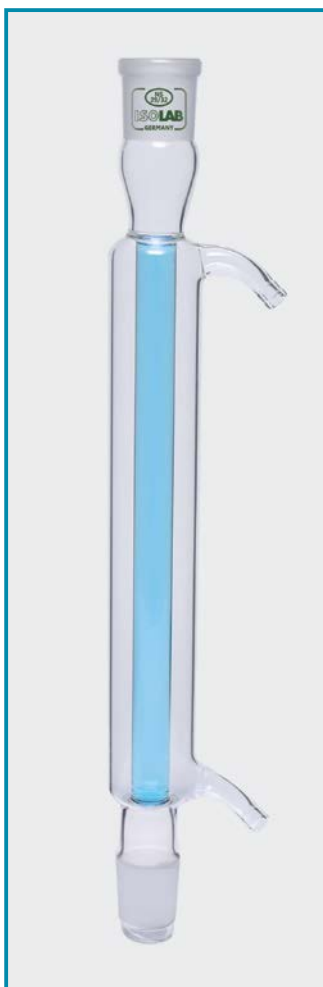

distillation & filtration & separation & sample preparation

CONDENSERS - "spiral" - "glass side arm"

► Manufactured from heat resistant, durable borosilicate glass according to DIN 12592 standard.

► Featured with glass side arms fitting 8-9 mm bore size tubings. Thick wall and reinforced rim prevent breakage during washing and transportation.

| catalogue number | effective length | joint NS size | pack quantity |
|------------------|------------------|---------------|---------------|
| 033.15.160 | 160 mm | NS 14/23 | 1 piece |
| 033.15.253 | 250 mm | NS 29/32 | 1 piece |
| 033.15.403 | 400 mm | NS 29/32 | 1 piece |

CONDENSERS - "spiral" - "P.P side arm"

► Manufactured from heat resistant, durable borosilicate glass according to DIN 12592 standard.

► Featured with GL 14 screw thread polypropylene side arms fitting 8-9 mm bore size tubings. Side arms can be easily connected or disconnected preventing breakage.

► Thick wall and reinforced rim prevent breakage during washing and transportation.

| catalogue number | effective length | joint NS size | pack quantity |
|------------------|------------------|---------------|---------------|
| 033.16.160 | 160 mm | NS 14/23 | 1 piece |
| 033.16.253 | 250 mm | NS 29/32 | 1 piece |
| 033.16.403 | 400 mm | NS 29/32 | 1 piece |

CONDENSERS - "dimroth" - "glass side arm"

► Manufactured from heat resistant, durable borosilicate glass according to DIN 12591 standard. Featured with glass side arms fitting 8-9 mm bore size tubings. Thick wall and reinforced rim prevent breakage.

| catalogue number | effective length | joint NS size | pack quantity |
|------------------|------------------|---------------|---------------|
| 033.17.160 | 160 mm | NS 14/23 | 1 piece |
| 033.17.163 | 160 mm | NS 29/32 | 1 piece |
| 033.17.250 | 250 mm | NS 14/23 | 1 piece |
| 033.17.253 | 250 mm | NS 29/32 | 1 piece |
| 033.17.400 | 400 mm | NS 14/23 | 1 piece |
| 033.17.403 | 400 mm | NS 29/32 | 1 piece |

CONDENSERS - "dimroth" - "P.P side arm"

► Manufactured from heat resistant, durable borosilicate glass according to DIN 12591 standard.

► Featured with GL 14 screw thread polypropylene side arms fitting 8-9 mm bore size tubings. Side arms can be easily connected or disconnected preventing breakage.

| catalogue number | effective length | joint NS size | pack quantity |
|------------------|------------------|---------------|---------------|
| 033.18.160 | 160 mm | NS 14/23 | 1 piece |
| 033.18.163 | 160 mm | NS 29/32 | 1 piece |
| 033.18.250 | 250 mm | NS 14/23 | 1 piece |
| 033.18.253 | 250 mm | NS 29/32 | 1 piece |
| 033.18.400 | 400 mm | NS 14/23 | 1 piece |
| 033.18.403 | 400 mm | NS 29/32 | 1 piece |

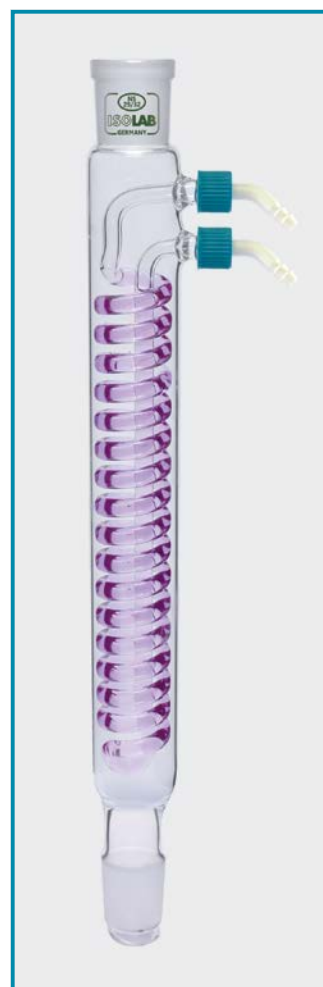
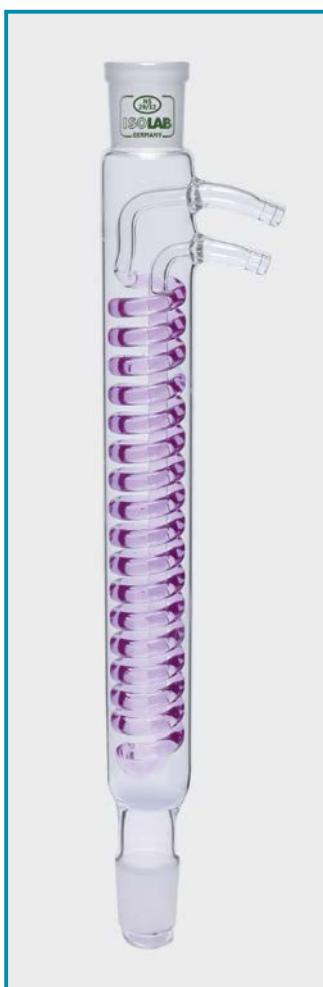
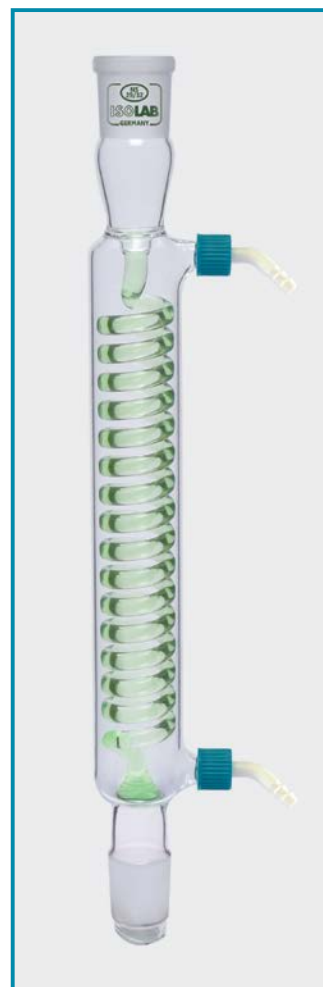
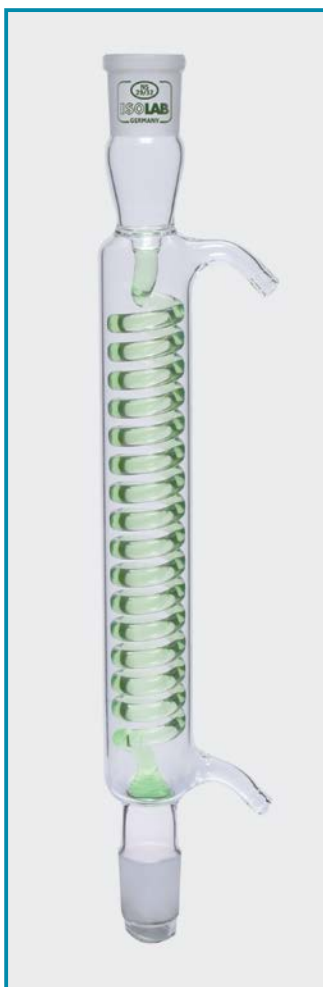

distillation & filtration & separation & sample preparation

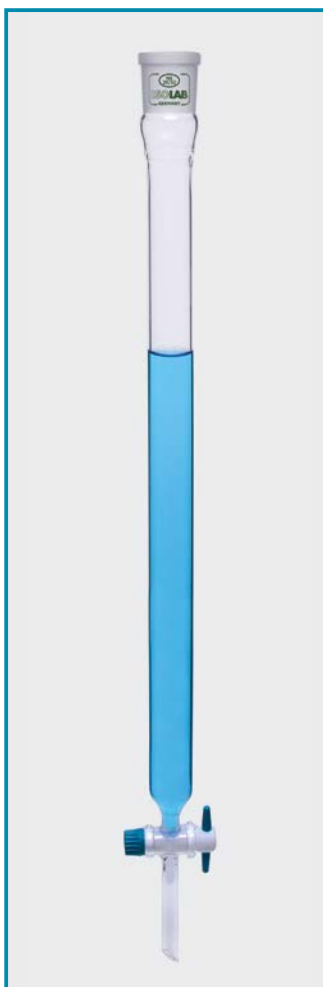

COLUMNS - "chromotography" - "w/o filter"

- Manufactured from borosilicate glass without filter.
- Thick wall and reinforced rim prevent breakage during washing and transportation.
- NS joints are manufactured according to DIN 12242 standard. Supplied with an interchangeable PTFE stopcock which does not require greasing at all.

| catalogue number | effective length | internal diameter | socket NS size | pack quantity |
|------------------|------------------|-------------------|----------------|---------------|
| 066.10.001 | 200 mm | 10 mm | NS 14/23 | 1 piece |
| 066.10.003 | 400 mm | 20 mm | NS 29/32 | 1 piece |
| 066.10.004 | 600 mm | 30 mm | NS 29/32 | 1 piece |

COLUMNS - "chromotography" - "with filter"

- Manufactured from borosilicate glass with "pore 1" size sintered glass filter. Reinforced rim prevent breakage.
- Perfectly grinded NS necks with smooth interior are manufactured according to DIN 12242 standard. Supplied with an interchangeable PTFE stopcock which does not require greasing at all.

| catalogue number | effective length | internal diameter | socket NS size | pack quantity |
|------------------|------------------|-------------------|----------------|---------------|
| 066.11.001 | 200 mm | 10 mm | NS 14/23 | 1 piece |
| 066.11.003 | 200 mm | 15 mm | NS 14/23 | 1 piece |
| 066.11.002 | 300 mm | 10 mm | NS 14/23 | 1 piece |
| 066.11.004 | 400 mm | 20 mm | NS 29/32 | 1 piece |
| 066.11.005 | 600 mm | 30 mm | NS 29/32 | 1 piece |

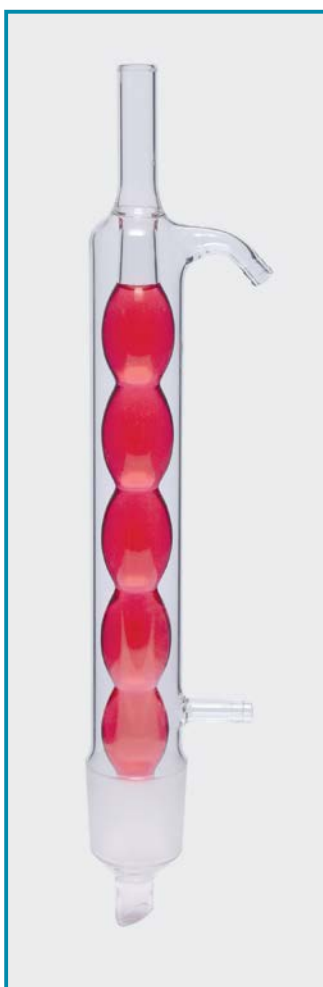
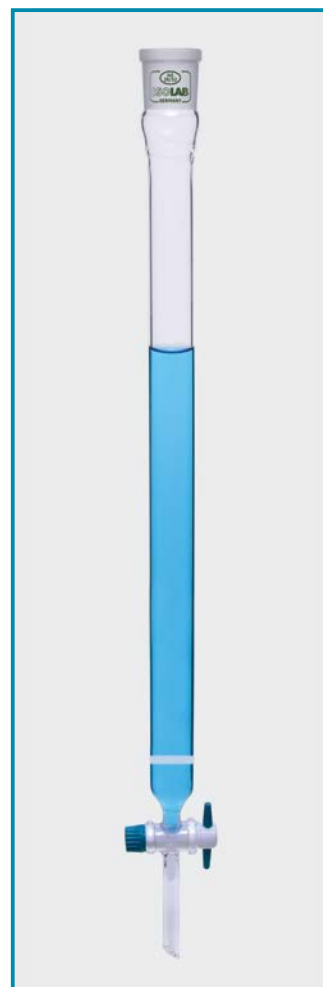

CONDENSERS - "soxhlet" - "allihn" - "glass arm"

- Manufactured from heat resistant, durable borosilicate glass according to DIN 12581 standard.
- Featured with glass side arms fitting 8-9 mm bore size tubings. Thick wall and reinforced rim prevent breakage during washing and transportation.

| catalogue number | for extractor volume | cone NS size | pack quantity |
|------------------|----------------------|--------------|---------------|
| 035.11.030 | 30 ml | NS 29/32 | 1 piece |
| 035.11.070 | 70 ml | NS 34/35 | 1 piece |
| 035.11.250 | 100 / 250 ml | NS 45/40 | 1 piece |
| 035.11.500 | 500 ml | NS 45/40 | 1 piece |

CONDENSERS - "soxhlet" - "allihn" - "P.P arm"

- Manufactured from heat resistant, durable borosilicate glass according to DIN 12581 standard. Thick wall, and reinforced rim prevent breakage during washing and transportation.
- Featured with GL 14 screw thread polypropylene side arms fitting 8-9 mm bore size tubings. Side arms can be easily connected or disconnected to the main body preventing accidental breakage.

| catalogue number | for extractor volume | cone NS size | pack quantity |
|------------------|----------------------|--------------|---------------|
| 035.12.030 | 30 ml | NS 29/32 | 1 piece |
| 035.12.070 | 70 ml | NS 34/35 | 1 piece |
| 035.12.250 | 100 / 250 ml | NS 45/40 | 1 piece |
| 035.12.500 | 500 ml | NS 45/40 | 1 piece |

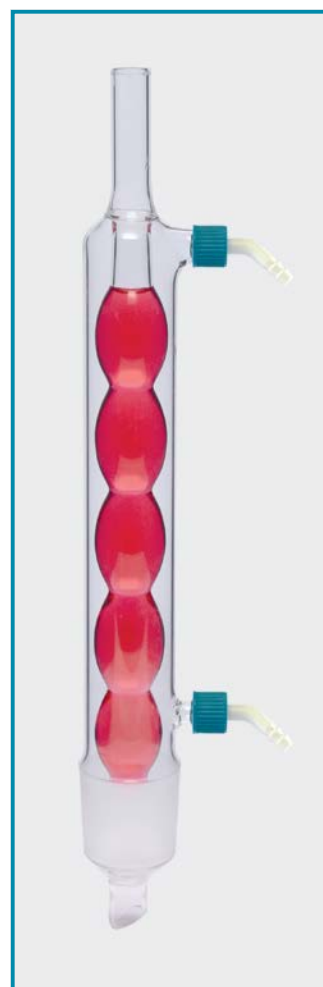

distillation & filtration & separation & sample preparation

CONDENSERS - "soxhlet"- "dimroth"- "glass arm"

► Manufactured from heat resistant, durable borosilicate glass according to DIN 12591 standard.

► Featured with glass side arms fitting 8-9 mm bore size tubings. Thick wall and reinforced rim prevent breakage during washing and transportation.

| catalogue number | for extractor volume | cone NS size | pack quantity |
|------------------|----------------------|--------------|---------------|
| 035.13.030 | 30 ml | NS 29/32 | 1 piece |
| 035.13.070 | 70 ml | NS 34/35 | 1 piece |
| 035.13.250 | 100 / 250 ml | NS 45/40 | 1 piece |
| 035.13.500 | 500 ml | NS 45/40 | 1 piece |

CONDENSERS - "soxhlet"- "dimroth"- "P.P arm"

► Manufactured from heat resistant, durable borosilicate glass according to DIN 12591 standard. Thick wall and reinforced rim prevent breakage during washing and transportation.

► Featured with GL 14 screw thread polypropylene side arms fitting 8-9 mm bore size tubings. Side arms can be easily connected or disconnected to the main body preventing accidental breakage.

| catalogue number | for extractor volume | cone NS size | pack quantity |
|------------------|----------------------|--------------|---------------|
| 035.14.030 | 30 ml | NS 29/32 | 1 piece |
| 035.14.070 | 70 ml | NS 34/35 | 1 piece |
| 035.14.250 | 100 / 250 ml | NS 45/40 | 1 piece |
| 035.14.500 | 500 ml | NS 45/40 | 1 piece |



EXTRACTORS "soxhlet"

► Manufactured from heat resistant, durable borosilicate glass without stopcock according to DIN 12602 standard.

► Thick wall and reinforced rim prevent breakage during washing and transportation.

► Perfectly grinded NS joint with smooth interior guarantees perfect leakproof sealing.

| catalogue number | volume | pack quantity |
|------------------|--------|---------------|
| 036.01.030 | 30 ml | 1 piece |
| 036.01.070 | 70 ml | 1 piece |
| 036.01.100 | 100 ml | 1 piece |
| 036.01.150 | 150 ml | 1 piece |
| 036.01.250 | 250 ml | 1 piece |
| 036.01.500 | 500 ml | 1 piece |

| catalogue number | socket NS size |
|------------------|----------------|
| 036.01.030 | NS 29/32 |
| 036.01.070 | NS 34/35 |
| 036.01.100 | NS 45/40 |
| 036.01.150 | NS 45/40 |
| 036.01.250 | NS 45/40 |
| 036.01.500 | NS 45/40 |



EXTRACTOR THIMBLES - "cellulose"

► Manufactured from thick and 100 % pure cotton fibres for reproducible results without any harm to the samples.

► Offers high temperature resistance up to 550°C, high mechanical strength and excellent retention capacity.

► Controlled dimensional accuracy guarantees excellent fitting to the extractors body.

► Also suitable for extracting solid or liquid samples from the gases.



| catalogue number | diameter | height | pack quantity |
|------------------|----------|--------|---------------|
| 102.28.080 | 28 mm | 80 mm | 25 pieces |
| 102.30.080 | 30 mm | 80 mm | 25 pieces |
| 102.33.080 | 33 mm | 80 mm | 25 pieces |
| 102.33.094 | 33 mm | 94 mm | 25 pieces |
| 102.34.120 | 34 mm | 120 mm | 25 pieces |

distillation & filtration & separation & sample preparation

ERLENMEYERS - "glass" - "ground neck"



➤ Manufactured from heat resistant, durable borosilicate glass according to DIN EN ISO 4797 standard.

➤ Thick wall, heavy base and reinforced rim prevent breakage during washing and transportation.

➤ Perfectly grinded NS necks with smooth interior guarantee excellent leak-proof closure.

| clear erlenmeyers | amber erlenmeyers | volume | neck NS size | pack quantity |
|-------------------|-------------------|---------|--------------|---------------|
| 028.01.050 | | 50 ml | NS 14/23 | 1 piece |
| 028.01.051 | | 50 ml | NS 19/26 | 1 piece |
| 028.01.052 | | 50 ml | NS 24/29 | 1 piece |
| 028.01.053 | 028.11.053 | 50 ml | NS 29/32 | 1 piece |
| 028.01.100 | | 100 ml | NS 14/23 | 1 piece |
| 028.01.101 | | 100 ml | NS 19/26 | 1 piece |
| 028.01.102 | | 100 ml | NS 24/29 | 1 piece |
| 028.01.103 | 028.11.103 | 100 ml | NS 29/32 | 1 piece |
| 028.01.250 | | 250 ml | NS 19/26 | 1 piece |
| 028.01.251 | | 250 ml | NS 24/29 | 1 piece |
| 028.01.252 | 028.11.252 | 250 ml | NS 29/32 | 1 piece |
| 028.01.300 | | 300 ml | NS 29/32 | 1 piece |
| 028.01.500 | | 500 ml | NS 19/26 | 1 piece |
| 028.01.501 | | 500 ml | NS 24/29 | 1 piece |
| 028.01.502 | 028.11.502 | 500 ml | NS 29/32 | 1 piece |
| 028.01.901 | 028.11.901 | 1000 ml | NS 29/32 | 1 piece |
| 028.01.902 | 028.11.902 | 2000 ml | NS 29/32 | 1 piece |

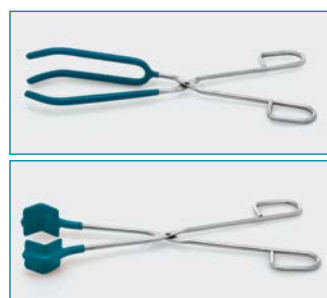

Various flasks tongs can be selected from cat. page no 52.



Various stoppers can be selected from cat. page no 69.

FLASKS - "glass" - "ground neck"



➤ Manufactured from heat resistant, durable borosilicate glass according to DIN EN ISO 4797 standard.

➤ Thick wall, heavy base and reinforced rim prevent breakage during washing and transportation.

➤ Perfectly grinded NS necks with smooth interior guarantee excellent leak-proof closure.



| flat bottom clear | round bottom clear | round bottom amber | volume | NS size | pack quantity |
|-------------------|--------------------|--------------------|---------|----------|---------------|
| 030.01.050 | 030.02.050 | | 50 ml | NS 14/23 | 1 piece |
| 030.01.051 | 030.02.051 | | 50 ml | NS 19/26 | 1 piece |
| 030.01.052 | 030.02.052 | | 50 ml | NS 24/29 | 1 piece |
| 030.01.053 | 030.02.053 | 030.12.053 | 50 ml | NS 29/32 | 1 piece |
| 030.01.100 | 030.02.100 | | 100 ml | NS 14/23 | 1 piece |
| 030.01.101 | 030.02.101 | | 100 ml | NS 19/26 | 1 piece |
| 030.01.102 | 030.02.102 | | 100 ml | NS 24/29 | 1 piece |
| 030.01.103 | 030.02.103 | 030.12.103 | 100 ml | NS 29/32 | 1 piece |
| 030.01.250 | 030.02.250 | | 250 ml | NS 19/26 | 1 piece |
| 030.01.251 | 030.02.251 | | 250 ml | NS 24/29 | 1 piece |
| 030.01.252 | 030.02.252 | 030.12.252 | 250 ml | NS 29/32 | 1 piece |
| 030.01.500 | 030.02.500 | | 500 ml | NS 24/29 | 1 piece |
| 030.01.501 | 030.02.501 | 030.12.501 | 500 ml | NS 29/32 | 1 piece |
| 030.01.900 | 030.02.900 | | 1000 ml | NS 24/29 | 1 piece |
| 030.01.901 | 030.02.901 | 030.12.901 | 1000 ml | NS 29/32 | 1 piece |
| 030.01.902 | 030.02.902 | | 2000 ml | NS 29/32 | 1 piece |
| 030.01.904 | 030.02.904 | | 4000 ml | NS 29/32 | 1 piece |

distillation & filtration & separation & sample preparation



**FLASKS - "2 ground neck"
"20° angled & parallel side neck"**

➤ Manufactured from heat resistant, durable borosilicate glass according to DIN 12392 & DIN12394 standards.

➤ Thick wall, heavy base and reinforced rim prevent breakage during washing and transportation.

➤ Perfectly grinded NS necks with smooth interior guarantee excellent leak-proof closure.

| flasks angled side neck | flasks parallel side neck | volume | center NS size | side NS size |
|-------------------------|---------------------------|---------|----------------|--------------|
| 030.24.050 | 030.30.050 | 50 ml | 14/23 | 14/23 |
| 030.24.100 | 030.30.100 | 100 ml | 14/23 | 14/23 |
| 030.24.250 | 030.30.250 | 250 ml | 14/23 | 14/23 |
| 030.25.100 | 030.31.100 | 100 ml | 24/29 | 14/23 |
| 030.25.250 | 030.31.250 | 250 ml | 24/29 | 14/23 |
| 030.25.500 | 030.31.500 | 500 ml | 24/29 | 14/23 |
| 030.25.901 | 030.31.901 | 1000 ml | 24/29 | 14/23 |
| 030.26.100 | 030.32.100 | 100 ml | 24/29 | 19/26 |
| 030.26.250 | 030.32.250 | 250 ml | 24/29 | 19/26 |
| 030.26.500 | 030.32.500 | 500 ml | 24/29 | 19/26 |
| 030.26.901 | 030.32.901 | 1000 ml | 24/29 | 19/26 |
| 030.27.100 | 030.33.100 | 100 ml | 29/32 | 14/23 |
| 030.27.250 | 030.33.250 | 250 ml | 29/32 | 14/23 |
| 030.27.500 | 030.33.500 | 500 ml | 29/32 | 14/23 |
| 030.27.901 | 030.33.901 | 1000 ml | 29/32 | 14/23 |
| 030.27.902 | 030.33.902 | 2000 ml | 29/32 | 14/23 |
| 030.28.100 | 030.34.100 | 100 ml | 29/32 | 19/26 |
| 030.28.250 | 030.34.250 | 250 ml | 29/32 | 19/26 |
| 030.28.500 | 030.34.500 | 500 ml | 29/32 | 19/26 |
| 030.28.901 | 030.34.901 | 1000 ml | 29/32 | 19/26 |
| 030.28.902 | 030.34.902 | 2000 ml | 29/32 | 19/26 |
| 030.29.100 | 030.35.100 | 100 ml | 29/32 | 29/32 |
| 030.29.250 | 030.35.250 | 250 ml | 29/32 | 29/32 |
| 030.29.500 | 030.35.500 | 500 ml | 29/32 | 29/32 |
| 030.29.901 | 030.35.901 | 1000 ml | 29/32 | 29/32 |
| 030.29.902 | 030.35.902 | 2000 ml | 29/32 | 29/32 |



**FLASKS - "3 ground neck"
"20° angled & parallel side neck"**

➤ Manufactured from heat resistant, durable borosilicate glass according to DIN 12392 & DIN12394 standards.

➤ Thick wall, heavy base and reinforced rim prevent breakage during washing and transportation.

➤ Perfectly grinded NS necks with smooth interior guarantee excellent leak-proof closure.

| flasks angled side neck | flasks parallel side neck | volume | center NS size | side NS size |
|-------------------------|---------------------------|---------|----------------|--------------|
| 030.36.250 | 030.42.250 | 250 ml | 14/23 | 14/23 |
| 030.37.250 | 030.43.250 | 250 ml | 24/29 | 14/23 |
| 030.37.500 | 030.43.500 | 500 ml | 24/29 | 14/23 |
| 030.37.901 | 030.43.901 | 1000 ml | 24/29 | 14/23 |
| 030.38.250 | 030.44.250 | 250 ml | 24/29 | 19/26 |
| 030.38.500 | 030.44.500 | 500 ml | 24/29 | 19/26 |
| 030.38.901 | 030.44.901 | 1000 ml | 24/29 | 19/26 |
| 030.38.902 | 030.44.902 | 2000 ml | 24/29 | 19/26 |
| 030.39.250 | 030.45.250 | 250 ml | 29/32 | 14/23 |
| 030.39.500 | 030.45.500 | 500 ml | 29/32 | 14/23 |
| 030.39.901 | 030.45.901 | 1000 ml | 29/32 | 14/23 |
| 030.40.250 | 030.46.250 | 250 ml | 29/32 | 19/26 |
| 030.40.500 | 030.46.500 | 500 ml | 29/32 | 19/26 |
| 030.40.901 | 030.46.901 | 1000 ml | 29/32 | 19/26 |
| 030.41.250 | 030.47.250 | 250 ml | 29/32 | 29/32 |
| 030.41.500 | 030.47.500 | 500 ml | 29/32 | 29/32 |
| 030.41.901 | 030.47.901 | 1000 ml | 29/32 | 29/32 |
| 030.41.902 | 030.47.902 | 2000 ml | 29/32 | 29/32 |



distillation & filtration & separation & sample preparation

FLASKS - "clear" - "glass" - "pear shape"



➤ Manufactured from heat resistant, durable borosilicate glass according to DIN 12383 standard.

➤ Thick wall, heavy base and reinforced rim prevent breakage during washing and transportation.

➤ Perfectly grinded NS necks with smooth interior guarantee excellent leak-proof closure.

| catalogue number | volume | NS size | pack qty. |
|------------------|--------|----------|-----------|
| 030.49.010 | 10 ml | NS 14/23 | 1 pc |
| 030.49.025 | 25 ml | NS 14/23 | 1 pc |
| 030.49.050 | 50 ml | NS 14/23 | 1 pc |
| 030.49.100 | 100 ml | NS 14/23 | 1 pc |
| 030.49.250 | 250 ml | NS 14/23 | 1 pc |
| 030.52.050 | 50 ml | NS 29/32 | 1 pc |
| 030.52.100 | 100 ml | NS 29/32 | 1 pc |
| 030.52.250 | 250 ml | NS 29/32 | 1 pc |

FLASKS - "glass" - "evaporating"



➤ Manufactured from heat resistant, durable borosilicate glass.

➤ Thick wall, heavy base and reinforced rim prevent breakage during washing and transportation.

➤ Perfectly grinded NS necks with smooth interior guarantee excellent leak-proof closure.

➤ Volume graduations and inscriptions are printed with white enamel.

| catalogue number | volume | evaporating NS size | pack quantity |
|------------------|---------|---------------------|---------------|
| 030.55.100 | 100 ml | NS 29/32 | 1 piece |
| 030.55.250 | 250 ml | NS 29/32 | 1 piece |
| 030.55.500 | 500 ml | NS 29/32 | 1 piece |
| 030.55.901 | 1000 ml | NS 29/32 | 1 piece |

FLASKS - "clear" - "glass" - "kjeldahl"



➤ Manufactured from heat resistant, durable borosilicate glass according to DIN 12360 standard.

➤ Thick wall, heavy base and reinforced rim prevent breakage during washing and transportation.

➤ Perfectly grinded NS necks with smooth interior guarantee excellent leak-proof closure.

| catalogue number | volume | NS size | pack qty. |
|------------------|--------|----------|-----------|
| 030.57.100 | 100ml | NS 19/26 | 1 pc |
| 030.57.250 | 250ml | NS 29/32 | 1 pc |
| 030.57.500 | 500ml | NS 29/32 | 1 pc |
| 030.57.750 | 750ml | NS 29/32 | 1 pc |
| 030.57.901 | 1000ml | NS 29/32 | 1 pc |

FLASKS - "receiving"

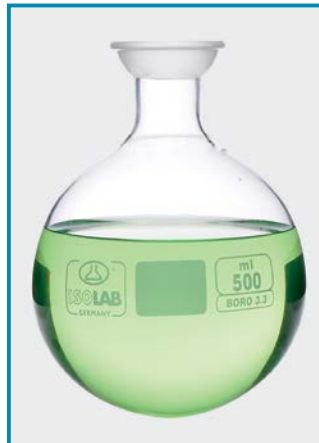

➤ Manufactured from heat resistant, durable borosilicate glass.

➤ Thick wall, heavy base and reinforced rim prevent breakage during washing and transportation.

➤ Perfectly grinded NS necks with smooth interior guarantee excellent leak-proof closure.

| catalogue number | volume | receiving NS size | pack quantity |
|------------------|---------|-------------------|---------------|
| 030.56.100 | 100 ml | KS 35 | 1 piece |
| 030.56.250 | 250 ml | KS 35 | 1 piece |
| 030.56.500 | 500 ml | KS 35 | 1 piece |
| 030.56.901 | 1000 ml | KS 35 | 1 piece |

CLIPS - "for receiving flasks"

➤ Manufactured from stainless steel with excellent chemical resistance and superior mechanical strength.

➤ Perfect tools to keep two KS joints fastened firmly to each other.

| catalogue number | pack quantity |
|------------------|---------------|
| 063.05.001 | 1 piece |



distillation & filtration & separation & sample preparation

FLASKS - "clear" - "glass" - "nitrogen"



► Manufactured from heat resistant, durable borosilicate glass according to DIN and ISO standards. Featured with an 25° angle PTFE stopcock.

► Thick wall, heavy base and reinforced rim prevent breakage during washing and transportation.

► Perfectly grinded NS necks with smooth interior guarantee excellent leak-proof closure.

| catalogue number | volume | neck NS size | pack quantity |
|------------------|---------|--------------|---------------|
| 030.58.025 | 25 ml | NS 14/23 | 1 piece |
| 030.58.050 | 50 ml | NS 14/23 | 1 piece |
| 030.58.100 | 100 ml | NS 14/23 | 1 piece |
| 030.58.250 | 250 ml | NS 14/23 | 1 piece |
| 030.59.050 | 50 ml | NS 29/32 | 1 piece |
| 030.59.100 | 100 ml | NS 29/32 | 1 piece |
| 030.59.250 | 250 ml | NS 29/32 | 1 piece |
| 030.59.500 | 500 ml | NS 29/32 | 1 piece |
| 030.59.901 | 1000 ml | NS 29/32 | 1 piece |



CLIPS - "for NS joints"

► Manufactured from POM with excellent chemical resistance and high mechanical strength.

► With their flexible jaws, they guarantee absolute leak-proof, tight connection of two NS joints.

| catalogue number | color | NS size | pack quantity |
|------------------|--------|----------|---------------|
| 063.04.010 | black | NS 10/19 | 1 piece |
| 063.04.012 | purple | NS 12/21 | 1 piece |
| 063.04.014 | yellow | NS 14/23 | 1 piece |
| 063.04.019 | blue | NS 19/26 | 1 piece |
| 063.04.024 | green | NS 24/29 | 1 piece |
| 063.04.029 | red | NS 29/32 | 1 piece |
| 063.04.034 | orange | NS 34/35 | 1 piece |
| 063.04.045 | brown | NS 45/40 | 1 piece |

FLASK STANDS - "P.P"

► Manufactured from best quality heat resistant, polypropylene for holding round bottom flasks.

► Unique wall design offers an excellent support at every point of contact.

► Easily stackable due to the tapered body form for reducing storage space.

| catalogue number | for flasks volume | pack quantity |
|------------------|-------------------|---------------|
| 029.14.902 | 100 - 2000 ml | 1 piece |



FLASK STANDS - "cork"

► Manufactured from best quality heat resistant, non-porous, natural cork for holding round bottom flasks.

► Unique wall design offers an excellent support at every point of contact.

| catalogue number | recommended flask volume | pack quantity |
|------------------|--------------------------|---------------|
| 029.04.001 | 50 - 100 ml | 1 piece |
| 029.04.002 | 250 - 500 ml | 1 piece |
| 029.04.003 | 1000 - 2000 ml | 1 piece |
| 029.04.004 | 4000 - 10000 ml | 1 piece |



distillation & filtration & separation & sample preparation



WATER STILLS - "basic"

- Offers space saving, and practical design with economical energy and water consumption. Supplies laboratory grade, distilled water free off pyrogen.
- Double walled interior chamber is manufactured from cavitation-proof, seamless, corrosion resistant stainless steel.
- Interior chamber should always be kept clean for consistent supply of pure water. Easily removable condenser unit enables fast and efficient cleaning of the chamber.
- Integrated low water protection system turns off heating in case lack of water. Integrated over temperature protection system turns off heating in case of a sudden increase of heat.
- Automatic circuit breakers ensure user safety in case of over temperature and over current problems.

| catalogue no | 623.01.004 | 623.01.008 |
|----------------------------|--|-----------------|
| dimensions (mm) | 380 x 290 x 580 | 380 x 365 x 640 |
| voltage (V) | 220 | 220 |
| frequency (Hz) | 50 / 60 | 50 / 60 |
| heating power (W) | 3000 | 6000 |
| output capacity (L/hr) | 3,5 | 7,5 |
| cooling water usage (L/hr) | 30 - 50 | 60 - 80 |
| controler | hydraulic thermostat | |
| safety devices | over temperature breaker water level switch | |
| water conductivity | ~ 2,3 μ S | |



WATER STILLS - "automatic"

- Offers many advantages with fully automatic operation, space saving unique design economical energy and water consumption. Supplies laboratory grade, distilled water free off pyrogen.
- Built-in large storage tank stores the produced water. Double walled interior chamber is manufactured from cavitation-proof, corrosion resistant stainless steel.
- Interior chamber should always be kept clean for consistent pure water quality. Easily removable condenser unit enables fast and efficient cleaning of the chamber.
- Pre-filter system prevents undesired impurities to enter.
- Integrated low water protection system turns off heating in case of low water inlet or lack of water supplied.
- Integrated over temperature protection system turns off heating in case of a sudden increase of heat.

| catalogue no | 623.02.004 | 623.02.008 |
|----------------------------|---|-----------------|
| dimensions (mm) | 740 x 345 x 515 | 680 x 360 x 650 |
| voltage (V) | 220 | 220 |
| frequency (Hz) | 50 / 60 | 50 / 60 |
| heating power (W) | 3000 | 6000 |
| output capacity (L/hr) | 4 | 8 |
| storage capacity (L) | 8 | 14 |
| cooling water usage (L/hr) | 30 - 50 | 60 - 80v |
| controler | hydraulic thermostat | |
| safety devices | temperature breaker, water level switch water float level sensor | |
| water conductivity | ~ 2,3 μ S | |

PRE - FILTER

- Pre-filter system prevents undesired impurities and built-in large storage tank stores the produced water.
- Filter part in the pre-filter system should be controlled often and should be immediately replaced in case of dirt.

| catalogue number | pack quantity |
|------------------|---------------|
| 623.11.110 | 1 piece |



distillation & filtration & separation & sample preparation

ROTARY EVAPORATORS - "vertical"

- Featured with motorised quick-action lift that automatically raises the evaporation flask from the bath in case of any power failure.
- Chemical-resistant double PTFE system and patented pressure spring guarantees an excellent sealing during operation.
- Easy to read large digital LCD screen displays heating temperature, rotation speed, time and other parameters.
- Patented condenser design with 1.500 cm² effective cooling capacity guarantees excellent cooling effect.
- Unique motor action enabling selective rotation of the evaporation flask as clockwise or anti-clockwise movement guarantees effective results.
- Featured with an adjustable final position recognition system for protection of the glass parts from breakage.
- Timer function with time setting range 1 - 999 minute enables precise control of the operation.
- Supplied with a large, stainless steel 5 L water-oil bath with precise temperature control from ambient to 180°C.
- An automatic over-heat protection system automatically stops heating if the bath temperature exceeds 220°C.



Integrated operating panel for convenient control of the main unit and also the heating bath.

Unique design of the detachable operating panel enables remote control option and easy use of the panel outside the fume hood.



Featured with an adjustable final position recognition system for protection of the glass parts from breakage. Unique push-off device to release the flask and protect it from breaking.

Chemical-resistant double PTFE system and patented pressure spring guarantees an excellent sealing during operation.

Optimal interval operation offers dual action in clockwise and counter clockwise for the drying process.

| | |
|-------------------------------|------------------------|
| catalogue no (Vertical) | 605.01.001 |
| dimensions / weight (mm / kg) | 465 x 457 x 583 / 15,0 |
| power (W) | 1400 |
| voltage (V) | 220 |
| frequency (Hz) | 50 / 60 |
| heating range (°C) | ambient +5 to 180 |
| heating accuracy (°C) | ± 1,0 |
| speed range (rpm) | 20 - 280 |
| speed & temp. & time display | LCD |
| time setting range (min) | 1 - 999 |
| rotation direction | reversible |
| protection class | IP 20 |
| USB interface | yes |

spare parts for rotary evaporator

| catalogue number | product descriptions | pack quantity |
|------------------|---------------------------|---------------|
| 605.01.101 | vertical condenser | 1 piece |
| 605.01.115 | diagonal condenser | 1 piece |
| 605.01.102 | evaporating flask 50 ml | 1 piece |
| 605.01.103 | evaporating flask 100 ml | 1 piece |
| 605.01.104 | evaporating flask 250 ml | 1 piece |
| 605.01.105 | evaporating flask 500 ml | 1 piece |
| 605.01.106 | evaporating flask 1000 ml | 1 piece |
| 605.01.107 | evaporating flask 2000 ml | 1 piece |
| 605.01.108 | receiving flask 100 ml | 1 piece |
| 605.01.109 | receiving flask 250 ml | 1 piece |
| 605.01.110 | receiving flask 500 ml | 1 piece |
| 605.01.111 | receiving flask 1000 ml | 1 piece |
| 605.01.112 | foam brake | 1 piece |
| 605.01.113 | vapor tube | 1 piece |
| 605.01.114 | connection seal | 1 piece |

distillation & filtration & separation & sample preparation



FUNNELS
"glass" - "plain"

➤ Manufactured from heat resistant, durable borosilicate glass with short stem according to ISO 4798 standard.

➤ 60° cone filtering angle guarantees excellent adaptation of the filter papers.

| catalogue number | funnel diameter | pack quantity |
|------------------|-----------------|---------------|
| 041.01.040 | 40 mm | 10 pieces |
| 041.01.060 | 60 mm | 10 pieces |
| 041.01.080 | 80 mm | 10 pieces |
| 041.01.100 | 100 mm | 10 pieces |
| 041.01.120 | 120 mm | 6 pieces |
| 041.01.150 | 150 mm | 6 pieces |



FUNNELS
"PP" - "plain"

➤ Manufactured from translucent polypropylene with short stem according to ISO 4798 standard.

➤ 60° cone filtering angle guarantees excellent adaptation of the filter papers.

| catalogue number | funnel diameter | pack quantity |
|------------------|-----------------|---------------|
| 041.02.040 | 40 mm | 1 piece |
| 041.02.060 | 60 mm | 1 piece |
| 041.02.080 | 80 mm | 1 piece |
| 041.02.100 | 100 mm | 1 piece |
| 041.02.120 | 120 mm | 1 piece |
| 041.02.150 | 150 mm | 1 piece |



FUNNELS
"glass" - "analytical"

➤ Manufactured from borosilicate glass with long stem according to ISO 4798 standard.

➤ 60° cone filtering angle guarantees excellent adaptation of the filter papers.

➤ Internal helicoid ribs increase the filtering speed also prevent back pressure and airlocks.

| glass funnel | funnel diameter | pack quantity |
|--------------|-----------------|---------------|
| 041.03.080 | 80 mm | 1 piece |



FUNNELS
"PP" - "analytical"

➤ Manufactured from translucent polypropylene with short stem according to ISO 4798 standard.

➤ 60° cone filtering angle guarantees excellent adaptation of the filter papers.

➤ Internal helicoid ribs increase the filtering speed also prevent back pressure and airlocks.

| PP funnel | funnel diameter | pack quantity |
|------------|-----------------|---------------|
| 041.04.080 | 80 mm | 1 piece |



FUNNELS - "powder" - "PP & glass"

➤ Manufactured from polypropylene or from borosilicate glass specially for transferring powders.

➤ Stem guarantees perfect fit to the flask necks and large bore diameter guarantees fast delivery of the material.

| funnel diameter | PP funnels | glass funnels | cone NS size | pack quantity |
|-----------------|------------|---------------|--------------|---------------|
| 65 mm | 041.07.065 | 041.08.060 | 14/23 | 1 piece |
| 80 mm | 041.07.080 | 041.08.080 | 19/26 | 1 piece |
| 100 mm | 041.07.100 | 041.08.100 | 24/29 | 1 piece |
| 120 mm | 041.07.120 | 041.08.120 | 29/32 | 1 piece |
| 150 mm | 041.07.150 | | | 1 piece |



FUNNELS - "polypropylene" - "ribbed"



➤ Manufactured from translucent polypropylene with short stem according to ISO 4798 standard.

➤ Helicoid ribs increase the filtering speed also prevent back pressure and airlocks.

➤ 60° cone angle for perfect adaptation of the filter papers.

| catalogue number | funnel diameter | pack quantity |
|------------------|-----------------|---------------|
| 041.05.040 | 40 mm | 1 piece |
| 041.05.060 | 60 mm | 1 piece |
| 041.05.080 | 80 mm | 1 piece |
| 041.05.100 | 100 mm | 1 piece |
| 041.05.120 | 120 mm | 1 piece |
| 041.05.150 | 150 mm | 1 piece |

distillation & filtration & separation & sample preparation



FUNNELS HOLDERS
“steel” - “without bosshead”

➤ Manufactured from high quality, corrosion resistant chromated steel for holding all kinds of funnels up to 150 mm diameter in the most secure way.

➤ Unique ring shape with a slit offers practical use also with separating funnels.

| catalogue number | holder diameter | pack quantity |
|------------------|-----------------|---------------|
| 042.03.040 | 40 mm | 1 piece |
| 042.03.060 | 60 mm | 1 piece |
| 042.03.080 | 80 mm | 1 piece |
| 042.03.100 | 100 mm | 1 piece |



FUNNELS HOLDERS
“steel” - “with bosshead”

➤ Manufactured from high quality, corrosion resistant chromated steel for holding all kinds of funnels up to 150 mm diameter in the most secure way.

➤ Ring with slit offers use also with separating funnels.

➤ The boss head mounted to the stem enables fast and easy attachment of the funnel holder to the stand rods.

| catalogue number | holder diameter | pack quantity |
|------------------|-----------------|---------------|
| 042.04.040 | 40 mm | 1 piece |
| 042.04.060 | 60 mm | 1 piece |
| 042.04.080 | 80 mm | 1 piece |
| 042.04.100 | 100 mm | 1 piece |



FUNNELS HOLDER
“polypropylene” - “without slit”

➤ Manufactured from polypropylene for holding all kinds of funnels from 60 mm up to 150 mm diameter in the most secure way.

➤ Two tapered wedges in the locking system are used to ensure firm grip on rods of diameter range 10 mm to 13 mm.



Funnel holder without slit consists of 2 parts.

| catalogue number | pack quantity |
|------------------|---------------|
| 042.05.001 | 1 piece |



FUNNELS HOLDER
“polypropylene” - “with slit”

➤ Manufactured from polypropylene for holding all kinds of funnels from 60 mm up to 150 mm diameter in the most secure way.

➤ Specially recommended to be used with separating funnels.

➤ Two tapered wedges in the locking system are used to ensure firm grip on rods of diameter range 10 mm to 13 mm.



Funnel holder with slit consists of 1 part.

| catalogue number | pack quantity |
|------------------|---------------|
| 042.06.001 | 1 piece |



FUNNELS HOLDER
“steel” - “adjustable height”

➤ Manufactured from high quality, corrosion resistant chromated steel for holding all kinds of funnels up to 150 mm diameter in the most secure way.

➤ The extendable funnel ring guarantees practical use with different funnel heights.

| catalogue number | pack quantity |
|------------------|---------------|
| 042.06.010 | 1 piece |

distillation & filtration & separation & sample preparation



FLASKS - "filter"
"glass" - "glass side arm"

- Manufactured from borosilicate glass according to ISO 6556 standard.
- Featured with glass side arm fitting 6-10 mm bore size tubings.
- Thick wall, heavy base and reinforced rim prevent breakage during washing and transportation.

| catalogue number | volume | pack quantity |
|------------------|---------|---------------|
| 040.01.100 | 100 ml | 1 piece |
| 040.01.250 | 250 ml | 1 piece |
| 040.01.500 | 500 ml | 1 piece |
| 040.01.901 | 1000 ml | 1 piece |
| 040.01.902 | 2000 ml | 1 piece |



FLASKS - "filter"
"glass" - "P.P side arm"

- Manufactured from borosilicate glass according to ISO 6556 standard.
- Featured with GL 14 screw thread P.P side arm fitting 6-10 mm bore size tubings. Side arms can be easily connected or disconnected to the body preventing accidental breakage.

| catalogue number | volume | pack quantity |
|------------------|---------|---------------|
| 040.02.100 | 100 ml | 1 piece |
| 040.02.250 | 250 ml | 1 piece |
| 040.02.500 | 500 ml | 1 piece |
| 040.02.901 | 1000 ml | 1 piece |
| 040.02.902 | 2000 ml | 1 piece |



PROTECTIVE COLLARS
"for filter flasks"

- Manufactured from natural rubber with a special design that keeps the funnel and filtering flask always in center.
- These adapters also provide all-round protection reducing impact damages.
- Also clean seal is created between the flask rim and the funnel neck.

| catalogue number | for flask volume | pack quantity |
|------------------|------------------|---------------|
| 040.05.001 | 100 ml | 1 piece |
| 040.05.002 | 250 - 500 ml | 1 piece |
| 040.05.003 | 1000 ml | 1 piece |
| 040.05.004 | 2000 ml | 1 piece |



FUNNELS - "büchner"
"porcelain" - "P.P"

- Porcelain büchner funnels are manufactured from thick and robust glazed porcelain according to DIN 12905 to be used with filter funnels. Support plate with holes holds the filter paper allows maximum filtering speed.
- Polypropylene büchner funnels are manufactured from polypropylene with a perforated filter plate. The upper part can be stacked with the lower part to form a vacuum seal. Upper and lower parts can be separated for efficient cleaning.

| funnels porcelain | funnels P.P | inner diameter | pack quantity |
|-------------------|-------------|----------------|---------------|
| 042.01.070 | 042.02.070 | 75 mm | 1 piece |
| 042.01.090 | 042.02.090 | 90 mm | 1 piece |
| 042.01.110 | 042.02.110 | 110 mm | 1 piece |



distillation & filtration & separation & sample preparation

FUNNELS - "gooch" - "glass" "with sintered glass disc"



➤ Manufactured from heat resistant, durable borosilicate glass with an acid resistant sintered glass disc for filtration.

➤ Guarantees an easy and fast filtering without the need of any kind of filter paper.

➤ Heavy and thick body construction and reinforced rim prevent breakage during washing and transportation.

| catalogue number | nominal volume | porosity grade | type | pack quantity |
|------------------|----------------|----------------|------|---------------|
| 043.01.051 | 50 ml | 1 | 3 D | 1 piece |
| 043.01.052 | 50 ml | 2 | 3 D | 1 piece |
| 043.01.053 | 50 ml | 3 | 3 D | 1 piece |
| 043.01.054 | 50 ml | 4 | 3 D | 1 piece |
| 043.01.071 | 75 ml | 1 | 11 D | 1 piece |
| 043.01.072 | 75 ml | 2 | 11 D | 1 piece |
| 043.01.073 | 75 ml | 3 | 11 D | 1 piece |
| 043.01.074 | 75 ml | 4 | 11 D | 1 piece |
| 043.01.121 | 125 ml | 1 | 17 D | 1 piece |
| 043.01.122 | 125 ml | 2 | 17 D | 1 piece |
| 043.01.123 | 125 ml | 3 | 17 D | 1 piece |
| 043.01.124 | 125 ml | 4 | 17 D | 1 piece |
| 043.01.501 | 500 ml | 1 | 25 D | 1 piece |
| 043.01.502 | 500 ml | 2 | 25 D | 1 piece |
| 043.01.503 | 500 ml | 3 | 25 D | 1 piece |
| 043.01.504 | 500 ml | 4 | 25 D | 1 piece |



CRUCIBLES - "gooch" - "glass" - "with sintered glass disc"



➤ Manufactured from heat resistant, durable borosilicate glass with an acid resistant sintered glass disc for filtration.

➤ Guarantees an easy and fast filtering without the need of any kind of filter paper.

➤ Heavy and thick body construction and reinforced rim prevent breakage during washing and transportation.

| crucibles sint. glass | porosity grade | nominal volume | diameter | pack quantity |
|-----------------------|----------------|----------------|----------|---------------|
| 043.02.031 | 1 | 30 ml | 30 mm | 1 piece |
| 043.02.032 | 2 | 30 ml | 30 mm | 1 piece |
| 043.02.033 | 3 | 30 ml | 30 mm | 1 piece |
| 043.02.034 | 4 | 30 ml | 30 mm | 1 piece |
| 043.02.051 | 1 | 50 ml | 40 mm | 1 piece |
| 043.02.052 | 2 | 50 ml | 40 mm | 1 piece |
| 043.02.053 | 3 | 50 ml | 40 mm | 1 piece |
| 043.02.054 | 4 | 50 ml | 40 mm | 1 piece |



GASKETS - "natural rubber"

➤ Manufactured from natural rubber with conical body form. Designed to fit Buchner funnels and Gooch funnels.

➤ Can be used also reverse cleaning of filter crucibles and as a support to standard funnels.

➤ Conical body form guarantees perfect fitting of funnels, filter funnels and crucibles to the filter flask necks.

➤ Supplied as a set of 7 different size adapters which guarantee perfect fit to all filter funnel necks with different volume sizes.



catalogue number
040.06.001

pack quantity
1 set

CRUCIBLES - "gooch" - "porcelain" - "with perforated base"

➤ Manufactured from glazed porcelain with perforated bottom layer.

➤ The crucible body form guarantees perfect fit to "GUKO" adapters.

| crucibles sint. glass | nominal volume | diameter x height | pack quantity |
|-----------------------|----------------|-------------------|---------------|
| 043.08.015 | 15 ml | 29 x 33 mm | 6 pieces |
| 043.08.030 | 25 ml | 36 x 45 mm | 6 pieces |
| 043.08.050 | 40 ml | 40 x 50 mm | 6 pieces |

distillation & filtration & separation & sample preparation

VACUUM MANIFOLDS - "stainless steel"



Volume graduation inside walls of the funnels offer practical volume indication of the sample.



Closure clamps under each funnels once closed guarantee perfect and vacuum tight sealing.



The stainless steel frit filter supports 47/50 mm diameter ensures a uniform distribution.

➤ Vacuum manifolds allow filtration of multiple samples either at once or independently by controlling the separate branch valves. Suitable to be used with 47/50 mm diameter membrane filters.

➤ Body and the funnels are manufactured from AISI 304 quality stainless steel to be used at food, beverage, pharmaceutical and water quality laboratories.

➤ The main body is featured with handles on both sides for easy hold and carriage.

➤ Stainless steel funnels has a volume capacity of 500 ml. They can be used for sample volumes from 50 ml up to 500 ml.

➤ Volume graduation inside walls of the funnels offer practical volume indication of the sample.

➤ Attachment and removal of the funnels can be easily achieved with the attached closure clamp.

➤ Closure clamps under each funnel once closed guarantee perfect and vacuum tight sealing.

➤ The stainless steel frit filter support ensures a uniform distribution of the residues.

➤ All parts of vacuum filter set are fully autoclavable. They can also flame sterilized except o-rings.

➤ Vacuum manifolds are supplied with a cap for each funnel.

| catalogue number | manifold model | pack quantity |
|------------------|----------------|---------------|
| 043.05.101 | 1 station | 1 piece |
| 043.05.103 | 3 stations | 1 piece |
| 043.05.106 | 6 stations | 1 piece |

FILTER FLASK "for vacuum system"

➤ Manufactured from borosilicate glass according to ISO 6556 standard with a volume of 2000 ml. Featured with GL 14 screw thread polypropylene side arms fitting 6-10 mm bore size tubings.

➤ Side arms can be easily connected or disconnected for easy use.

FILTER BOTTLE "for vacuum system"

➤ Manufactured from borosilicate glass according to ISO 6556 standard with a volume of 5000 ml. Featured with GL 14 screw thread polypropylene side arms fitting 6-10 mm bore size tubings.

➤ Side arms can be easily connected or disconnected for easy use.

| filter flask | filter bottle | pack quantity |
|--------------|---------------|---------------|
| 043.06.001 | 043.06.011 | 1 piece |





VACUUM FILTER SET

➤ Manufactured from borosilicate glass particularly suitable for analysis of microscopic residues, particle controls and multipurpose filtration application.

➤ Thick wall, heavy base and reinforced rim prevent breakage during washing and transportation.

➤ Suitable to be used with 47/50 mm diameter membrane filters.

➤ Supplied with filter funnel of 300 ml volume capacity, support base with sintered disc, vacuum connection side arm, connecting clamp and 1000 ml flask.

| catalogue number | vacuum flask | pack quantity |
|------------------|--------------|---------------|
| 043.03.001 | 1000 ml | 1 piece |



VACUUM FLASK

➤ Manufactured from borosilicate glass with thick walls resistant to vacuum applications with NS 29/32 reverse joint.

| catalogue number | flask volume | pack quantity |
|------------------|--------------|---------------|
| 043.03.005 | 1000 ml | 1 piece |
| 043.03.007 | 2000 ml | 1 piece |



CLAMP

➤ Manufactured from aluminium for tight closure of the support base with sinter plate to the filter funnel.

| catalogue number | pack quantity |
|------------------|---------------|
| 043.03.002 | 1 piece |



FILTER FUNNEL

➤ Manufactured from borosilicate glass for excellent fit to the top of the support part.

| catalogue number | funnel volume | pack quantity |
|------------------|---------------|---------------|
| 043.03.003 | 300 ml | 1 piece |
| 043.03.006 | 500 ml | 1 piece |



SUPPORT BASE

➤ Manufactured from borosilicate glass with excellent fit to the bottom of the filter funnel with a glass filter disc plate.

| catalogue number | pack quantity |
|------------------|---------------|
| 043.03.004 | 1 piece |

distillation & filtration & separation & sample preparation



FILTER PAPERS - "quantitative"

- Quantitative papers are recommended for analytical and gravimetric analysis.
- Manufactured first from high quality 100% cellulose fibres. They are further treated with dilute acid to remove any remaining organic or inorganic impurities. As the last step they are washed and cleaned with demineralised water.
- They guarantee low ash content around less than 0,01% and around 95% alpha-cellulose amount.

| M. Nagel cat. no | ISOLAB cat. no | color code | filtration speed | diameter | pack quantity |
|------------------|----------------|------------|------------------|----------|---------------|
| 105.01.110 | 105.11.110 | blue | slow | 110 mm | 100 pieces |
| 105.02.110 | 105.12.110 | white | medium | 110 mm | 100 pieces |
| 105.03.110 | 105.13.110 | black | fast | 110 mm | 100 pieces |
| 105.01.125 | 105.11.125 | blue | slow | 125 mm | 100 pieces |
| 105.02.125 | 105.12.125 | white | medium | 125 mm | 100 pieces |
| 105.03.125 | 105.13.125 | black | fast | 125 mm | 100 pieces |



FILTER PAPERS - "general purpose"

- Manufactured from high quality 100% cellulose with a good humidity resistance and relatively high absorption capacity.
- Suitable for general laboratory filtrations. Alternatively, can also be used as a bench protector or pharmaceutical product preparation.

| catalogue number | paper dimensions | paper specifications | pack quantity |
|------------------|------------------|------------------------|---------------|
| 107.40.140 | 40 x 40 cm | 60 gr / m ² | 250 pieces |
| 107.58.158 | 58 x 58 cm | 60 gr / m ² | 250 pieces |



FILTER PAPERS - "qualitative"

- Qualitative papers are recommended for routine separation work.
- They are manufactured from high quality 100% cellulose fibres for consistent filtration speed, loading capacity and wet strength.
- They guarantee low ash content around less than 0,1% and around 59% alpha-cellulose amount.

| M. Nagel cat. no | ISOLAB cat. no | grade | filtration speed | diameter | pack quantity |
|------------------|----------------|-------|------------------|----------|---------------|
| 106.01.110 | 106.11.110 | No:2 | slow medium | 110 mm | 100 pieces |
| 106.02.110 | 106.12.110 | No:1 | medium | 110 mm | 100 pieces |
| 106.03.110 | 106.13.110 | No:4 | fast | 110 mm | 100 pieces |
| 106.01.125 | 106.11.125 | No:2 | slow medium | 125 mm | 100 pieces |
| 106.02.125 | 106.12.125 | No:1 | medium | 125 mm | 100 pieces |
| 106.03.125 | 106.13.125 | No:4 | fast | 125 mm | 100 pieces |



FORCEPS - "for filter papers"

- Manufactured from high quality, chemical and corrosion resistant AISI 304 grade stainless steel.
- Most commonly used forceps for placing and picking filter papers during filtering process.
- Robust and seamless construction guarantees long life cycle.
- Grid lines on the middle part enable safe and easy handling.

| catalogue number | total length | pack quantity |
|------------------|--------------|---------------|
| 048.04.001 | 120 mm | 1 piece |

distillation & filtration & separation & sample preparation

PUMPS - "vacuum & pressure"



➤ Ideal pumps for all kinds of filtration applications and also for air sampling, suspended solid tests, vacuum distillation, gel drying, chromatography applications. Can be used simultaneously both as a vacuum pump and as a pressure pump for pressure supply.

➤ Piston driven, belt free motor does not need any oil or lubricant and offers continuous oil free pumping. Siliconised rubber feet holds the pumps on the bench surface.

➤ Unique design of the pump guarantees maintenance free and long life cycle with minimum noise level less than 50dB.

➤ Filter barrier in the air exchange compartment of the pump enables clean air cycling at all times. Vacuum and pressure indicator at model 622.12.001 shows operational vacuum and pressure values at all times.

➤ Thermal protection system for overheating guarantees automatic stop in case of over heat during process.

| catalogue number | maximum flow rate | maximum vacuum | maximum pressure | tube thread | motor power | total weight | vacuum & pressure indicator | dimensions |
|------------------|-------------------|----------------|------------------|-------------|-------------|--------------|-----------------------------|----------------|
| 622.11.001 | 15 L/min. | 250 mbar | 30 Psi | 6 mm | 75 watt | 4 kg | non | 195x98x156 mm |
| 622.12.001 | 30 L/min. | 200 mbar | 30 Psi | 6 mm | 160 watt | 8 kg | yes | 210x160x235 mm |



WATER JET PUMP "polypropylene"

➤ Manufactured from polypropylene for continuous filtering applications.

➤ Suitable to operate under 10 kg/cm² water pressure.

➤ Featured with a non-return valve that eliminates water back flow.

➤ Easily dismantled for effective cleaning.

➤ Can be used also as a simple vacuum pump.

| catalogue number | pack quantity |
|------------------|---------------|
| 040.10.001 | 1 piece |



FLOW INDICATOR

➤ Manufactured from PMP for precise optical indication of the flow. Can resist up to 2 bar pressure. Can be used with tubings of 6 to 11 mm internal diameter.

➤ For optimum performance the minimum flow rate of 50 ml/minute (vertically) and 140 ml / minute (horizontally) is required.

➤ Functions in both directions and can be mounted with any angle.

| catalogue number | pack quantity |
|------------------|---------------|
| 052.18.001 | 1 piece |



NON-RETURN VALVE - "polypropylene"

➤ Manufactured from polypropylene for usage with tubing connections and vacuum systems.

➤ Prevents water back flow when the pressure declines. Useful for any tubing system and vacuum line.

➤ Max. safe working pressure at ambient temperature: 2,0 bar. Min. safe working pressure at ambient temperature: 0,07 bar.

| catalogue number | tube diameter | pack quantity |
|------------------|---------------|---------------|
| 040.10.005 | 8 - 11 mm | 1 piece |

distillation & filtration & separation & sample preparation



FUNNELS - "separating" "squib" - "graduated"

- Manufactured from heat resistant, durable borosilicate glass with graduation marks printed on the body according to ISO 4800.
- Thick wall and reinforced rim prevent breakage during washing and transportation.
- Perfectly grinded NS necks with smooth interior are manufactured according to DIN 12242 standard.
- Volume graduations and inscriptions are printed with white enamel.
- Supplied with P.E stopper and an interchangeable PTFE stopcock which does not require greasing.

| catalogue number | volume | neck NS size | pack quantity |
|------------------|---------|--------------|---------------|
| 031.02.050 | 50 ml | NS 19/26 | 1 piece |
| 031.02.100 | 100 ml | NS 19/26 | 1 piece |
| 031.02.250 | 250 ml | NS 29/32 | 1 piece |
| 031.02.500 | 500 ml | NS 29/32 | 1 piece |
| 031.02.901 | 1000 ml | NS 29/32 | 1 piece |
| 031.02.902 | 2000 ml | NS 29/32 | 1 piece |



FUNNELS - "separating" "conical" - "graduated"

- Manufactured from heat resistant, durable borosilicate glass with graduation marks printed on the body according to ISO 4800.
- Thick wall and reinforced rim prevent breakage during washing and transportation.
- Perfectly grinded NS necks with smooth interior are manufactured according to DIN 12242 standard.
- Volume graduations and inscriptions are printed with white enamel.
- Supplied with P.E stopper and an interchangeable PTFE stopcock which does not require greasing.

| catalogue number | volume | neck NS size | pack quantity |
|------------------|---------|--------------|---------------|
| 031.04.050 | 50 ml | NS 19/26 | 1 piece |
| 031.04.100 | 100 ml | NS 19/26 | 1 piece |
| 031.04.250 | 250 ml | NS 29/32 | 1 piece |
| 031.04.500 | 500 ml | NS 29/32 | 1 piece |
| 031.04.901 | 1000 ml | NS 29/32 | 1 piece |
| 031.04.902 | 2000 ml | NS 29/32 | 1 piece |



FUNNELS - "separating" "cylindrical" - "graduated"

- Manufactured from heat resistant, durable borosilicate glass with graduation marks printed on the body according to ISO 4800.
- Thick wall and reinforced rim prevent breakage during washing and transportation.
- Perfectly grinded NS necks with smooth interior are manufactured according to DIN 12242 standard.
- Volume graduations and inscriptions are printed with white enamel.
- Supplied with P.E stopper and an interchangeable PTFE stopcock which does not require greasing.

| catalogue number | volume | neck NS size | pack quantity |
|------------------|---------|--------------|---------------|
| 031.06.050 | 50 ml | NS 19/26 | 1 piece |
| 031.06.100 | 100 ml | NS 19/26 | 1 piece |
| 031.06.250 | 250 ml | NS 29/32 | 1 piece |
| 031.06.500 | 500 ml | NS 29/32 | 1 piece |
| 031.06.901 | 1000 ml | NS 29/32 | 1 piece |



**FUNNELS - "dropping"
"conical" - "graduated"**

- Manufactured from heat resistant, durable borosilicate glass with graduation marks printed on the body according to ISO 4800.
- Thick wall and reinforced rim prevent breakage during washing and transportation.
- Perfectly grinded NS necks with smooth interior are manufactured according to DIN 12242 standard.
- Volume graduations and inscriptions are printed with white enamel.
- Supplied with P.E stopper and an interchangeable PTFE stopcock which does not require greasing.

| catalogue number | volume | neck NS | cone NS | pack quantity |
|------------------|---------|---------|---------|---------------|
| 032.01.050 | 50 ml | 19/26 | 29/32 | 1 piece |
| 032.01.100 | 100 ml | 19/26 | 29/32 | 1 piece |
| 032.01.250 | 250 ml | 29/32 | 29/32 | 1 piece |
| 032.01.500 | 500 ml | 29/32 | 29/32 | 1 piece |
| 032.01.901 | 1000 ml | 29/32 | 29/32 | 1 piece |



**FUNNELS - "dropping"
"cylindrical" - "graduated"**

- Manufactured from heat resistant, durable borosilicate glass with graduation marks printed on the body according to ISO 4800.
- Thick wall and reinforced rim prevent breakage during washing and transportation.
- Perfectly grinded NS necks with smooth interior are manufactured according to DIN 12242 standard.
- Volume graduations and inscriptions are printed with white enamel.
- Supplied with P.E stopper and an interchangeable PTFE stopcock which does not require greasing.

| catalogue number | volume | neck NS | cone NS | pack quantity |
|------------------|---------|---------|---------|---------------|
| 032.02.050 | 50 ml | 19/26 | 29/32 | 1 piece |
| 032.02.100 | 100 ml | 19/26 | 29/32 | 1 piece |
| 032.02.250 | 250 ml | 29/32 | 29/32 | 1 piece |
| 032.02.500 | 500 ml | 29/32 | 29/32 | 1 piece |
| 032.02.901 | 1000 ml | 29/32 | 29/32 | 1 piece |



**FUNNELS - "dropping"
"cylindrical" - "graduated"
"with relief tube"**

- Manufactured from heat resistant, durable borosilicate glass with graduation marks printed on the body according to ISO 4800.
- Thick wall and reinforced rim prevent breakage.
- Perfectly grinded NS necks with smooth interior are manufactured according to DIN 12242 standard.
- Volume graduations and inscriptions are printed with white enamel.
- Supplied with P.E stopper and an interchangeable PTFE stopcock which does not require greasing.

| catalogue number | volume | neck NS | cone NS | pack quantity |
|------------------|---------|---------|---------|---------------|
| 032.03.050 | 50 ml | 19/26 | 29/32 | 1 piece |
| 032.03.100 | 100 ml | 19/26 | 29/32 | 1 piece |
| 032.03.250 | 250 ml | 29/32 | 29/32 | 1 piece |
| 032.03.500 | 500 ml | 29/32 | 29/32 | 1 piece |
| 032.03.901 | 1000 ml | 29/32 | 29/32 | 1 piece |

distillation & filtration & separation & sample preparation

CENTRIFUGE - "mini"

- Compact and easy to use personal centrifuge for quick spin downs, micro-filter cell separations, and HPLC samples.
- Durable transparent and UV resistant polycarbonate lid and ABS resin body.
- DC motor accelerates the rotor to the set speed with low vibration and also with a quiet operation less than 45 dB noise level.
- Starts and reaches a maximum speed of 7.000 rpm in seconds.
- Multi voltage design guarantees stable running and high accuracy of speed.
- Featured with a door interlock system for extra safety.
- For user safety electronic brake immediately stops when lid opens.
- Rotor is seated on a tapered shaft which enables tool-free, fast and easy exchange.
- Supplied with two rotors and adapters to accommodate 0,5 ml and 1,5 ml and 2 ml tubes and also PCR tubes.



6 cavity rotor designed for 1,5 & 2.0 ml tubes directly.



16 cavity rotor designed for 0,2 ml PCR tubes which can also hold 2 x 8 PCR strips.

| | |
|-------------------------------|---|
| catalogue no | 603.01.001 |
| dimensions / weight (mm / kg) | 175 x 140 x 117 / 0,5 |
| voltage (V) | 100 - 240 |
| frequency (Hz) | 50 / 60 |
| speed (rpm) | 7000 |
| maximum RCF (xg) | 2680 |
| noise level (dB) | < 45 |
| run time | continuous operation |
| rotor capacity | 0,2 / 0,5 / 1,5 / 2,0 ml x 6 0,2 ml x 16 PCR strips 0,2 ml x 2 PCR 8 strips |
| standard accessories | 16 cavity & 6 cavity rotors & adapters |



Easy to start: Close the lid, the rotor starts and instantly reaches 7.000 rpm.



Easy to stop: Open the lid, the electrical brake immediately stops the rotor.

distillation & filtration & separation & sample preparation

CENTRIFUGE - "mini" - "high speed"



- Ideal centrifuge for fast spins for higher RCF requirement, for PCR protocols, for microfilter cell separations, clinical applications and HPLC protocols.
- Offers memory function up to 10 different programs.
- Featured with an explosion proof and fully enclosed strong inner structure for full safety.
- Brushless DC motor accelerates the rotor to the set speed with low vibration and also with a quiet operation less than 56 dB noise level.
- Air evacuation system ensures free air flow during high speed to prevent samples being over heated.
- User friendly large LCD display enables easy setting and reading of the functional parameters.
- Both RPM and RCF can be set and displayed. The parameters can be modified after the set speed is reached.
- Metal casing with low gravity, provides stable and reliable running at maximum speed.
- Starts and reaches the maximum speed of 15.000 rpm with max 15.100 RCF in seconds. Speed can be set with an accuracy of +/- 20 rpm.
- Timer can be set from 30 seconds to 99 minutes or continuous running. Timer starts once the target speed is reached for more accurate operation time.
- Offers quick spins by pressing and holding the "pulse" key.
- Multi voltage design guarantees stable running and high accuracy of speed.
- Featured with a dual door interlock system for twice safety. Electronic brake immediately stops when lid opens for user safety.
- Lid is released automatically when the rotor stops.
- Rotor is sealed on a tapered shaft which enables tool-free, fast and easy exchange.
- Supplied with a 12 cavity rotor designed for 1,5&2.0 ml tubes directly.



User friendly large LCD display enables easy setting and reading of the functional parameters. Both RPM and RCF can be set and displayed.



High strength plastic rotor with excellent balance offers a stable operation. 12 cavity rotor designed for 1,5 & 2.0 ml tubes directly.

| | |
|-------------------------------|--|
| catalogue no | 603.02.001 |
| dimensions / weight (mm / kg) | 255 x 245 x 140 / 6,0 |
| voltage (V) | 100 - 240 |
| frequency (Hz) | 50 / 60 |
| maximum speed (rpm) | 15000 |
| maximum RCF (xg) | 15100 |
| speed accuracy (rpm) | ± 20 |
| increment (rpm) | 100 |
| noise level (dB) | < 56 |
| run time | timer & continuous operation |
| rotor capacity | 1,5 / 2,0 ml x 12 |
| standard accessories | 12 cavity rotors |
| safety devices | door interlock over speed detection over temperature detection automatic internal diagnosis |

distillation & filtration & separation & sample preparation



CENTRIFUGE - "clinical"

- Ideal centrifuge for fast separation of serum, plasma, urea, blood samples and other routine applications in medical, research and chemical laboratories.
- Explosion proof and marked as CE, cTUVus, and FCC. MCA test according to IEC/EN61010-2-10.
- Brushless DC motor accelerates the rotor to the set speed with low vibration and also with a quiet operation less than 56 dB noise level.
- User friendly large LCD display enables easy setting and reading of the functional parameters.
- Both RPM and RCF can be set and displayed. The parameters can be modified after the set speed is reached.
- Starts and reaches a maximum speed of 4.500 rpm with max 2.490 RCF in seconds. Speed can be set with an accuracy of +/- 20 rpm.
- Metal casing with low gravity, provides stable and reliable running at maximum speed.
- Timer can be set from 30 seconds to 99 minutes or continuous running. Timer starts once the target speed is reached for more accurate operation time.
- Short spin function is used for quick spins by pressing and holding the "pulse" key.
- Multi voltage design guarantees stable running and high accuracy of speed.
- Featured with a dual door interlock system for twice safety.
- Electronic brake immediately stops when lid opens for user safety. Lid is released automatically when the rotor stops.
- The unique design guarantees stable running and high accuracy of the speed. High strength rotor and excellent balance technology guarantees a quiet and stable operation.
- Delivered complete with a 8 cavity angled rotor and suitable adaptors to be used with 15 ml conical tubes and all kinds of blood collection tubes.

| | |
|-----------------------------------|--|
| catalogue no | 603.05.001 |
| dimensions / weight (mm / kg) | 255 x 245 x 140 / 6,0 |
| voltage (V) | 220 |
| frequency (Hz) | 50 |
| maximum speed (rpm) | 4500 |
| speed control (rpm) | increment of 100 |
| maximum RCF (xg) | 2490 |
| RCF control (xg) | increment of 100 |
| speed accuracy (rpm) | ± 20 |
| noise level (dB) | < 56 |
| run time | 30 sec. - 99 min. or continuous |
| acceleration / braking time (sec) | 20 s↑ 20 s↓ |
| safety devices | door interlock over - speed detection automatic internal diagnosis |
| additional features | sound alert function speed / RCF switch short time run function |



High strength plastic rotor and excellent balance technology to guarantee a quiet and stable operation.

Delivered complete with a 8 cavity angled rotor and suitable adaptors to be used with 15 ml conical tubes and all kinds of blood collection tubes.



User friendly large LCD display offers easy identification of parameters and shows all informations including accumulated running time and last running parameters.

Both RPM or G-force can be set and displayed. Parameters can be modified after the set speed is achieved.



Featured with a dual door interlock system for twice safety.

Electronic brake immediately stops when lid opens for user safety.

Lid is released automatically when the rotor stops.



*cleaning & safety
protection & sterilization*



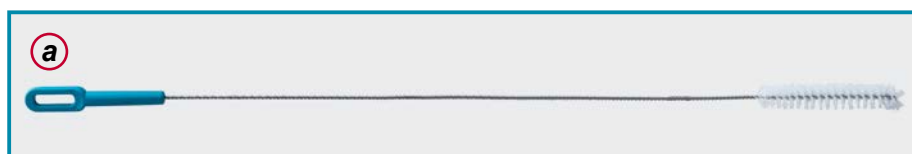
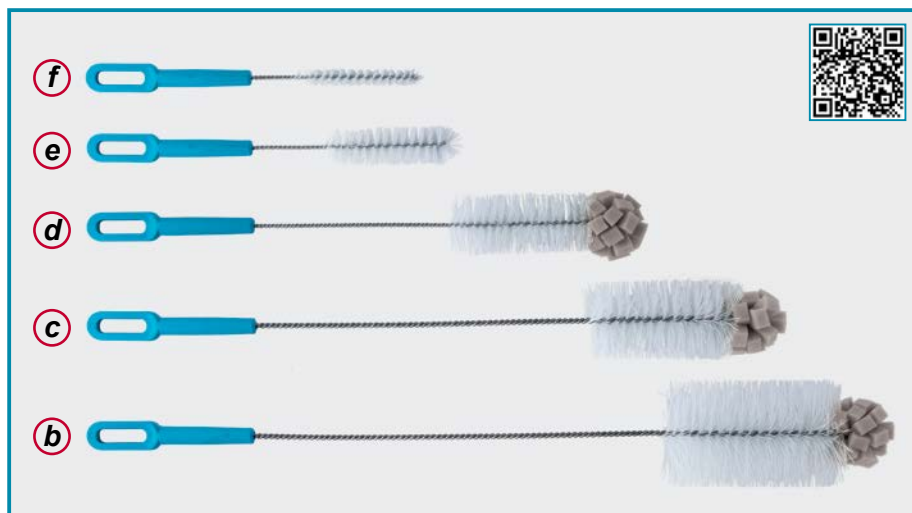

| brush code | catalogue number | product descriptions | brush diameter | brush length | pack quantity |
|------------|------------------|------------------------------------|----------------|--------------|---------------|
| a | 071.02.001 | Burette and tubings cleaning brush | 20 mm | 125 mm | 1 piece |
| b | 071.02.002 | Large size bottle cleaning brush | 70 mm | 130 mm | 1 piece |
| c | 071.02.003 | Medium size bottle cleaning brush | 50 mm | 110 mm | 1 piece |
| d | 071.02.004 | Small size bottle cleaning brush | 40 mm | 110 mm | 1 piece |
| e | 071.02.005 | Common test tubes cleaning brush | 25 mm | 100 mm | 1 piece |
| f | 071.02.006 | Narrow test tubes cleaning brush | 12 mm | 80 mm | 1 piece |

LABORATORY BRUSH "natural fibre / perlon"

- Excellent tools for washing and cleaning of all type of laboratory bottles, flasks, tubes, condensers, burettes etc.
- Brush material is manufactured from highest quality of fibre/perlon for long life cycle.
- Brush stem is manufactured from twisted steel wire.
- Brush handle is manufactured from polypropylene and offers extreme easy handling and use of the brush.
- Unique handle design enables hanging of the brush to a convenient place for easy reach.
- Spherical sponge top part enables access to every corner of the labware and guarantees perfect cleaning results.

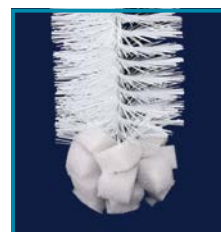

Spherical sponge top part enables access to every corner of the labware and guarantees perfect cleaning results.

LABORATORY BRUSH "hinged & swivel head"

- Specially recommended for curved and cornered labware such as round bottom flasks.
- Uniquely designed convex swiveling brush head gets contact with all over the surface of the flask including difficult curves and corners and enables thorough cleaning.
- The brush head has a slightly convex shape for fast and effective cleaning even also at heavy soiled flasks.
- Strong yet flexible bristles provide long lasting trouble free life cycle. Good grip due to the solid and long wooden handle.
- The swivel brush part fits through NS 29/32 or larger or any non tapered neck with a diameter 24 mm or larger.
- 360 mm length brush handle offers easy touch of the bottoms of larger size flasks.

| catalogue number | swivel head size | handle length | pack quantity |
|------------------|------------------|---------------|---------------|
| 071.03.001 | 21x44x24 mm | 360 mm | 1 piece |



LABORATORY BRUSH - "non - absorbant foam"

➤ **Manufactured from non-absorbant reinforced foam which will not absorb water and not become soggy even after multiple use.** ➤ **Essentially much longer lasting than other common brushes.** ➤ **Cleans laboratory glassware with minimum effort and maximum efficiency.** ➤ **Will not chip, break or scratch laboratory glassware, can also be safely used on plastic labware.** ➤ **Ergonomically designed wide handles enable easy rotating of brush.**

LABORATORY BRUSH - "flexible"

➤ Specially recommended for labware with narrow neck and wider base such as flasks, erlenmeyers, bottles etc.

➤ Featured with a flexible body which perfectly adapts to the base and interior wall shape of the vessel to be cleaned.

➤ Offers perfect cleaning also for large size labwares with it's total length 370 mm and brush diameter 20 mm.

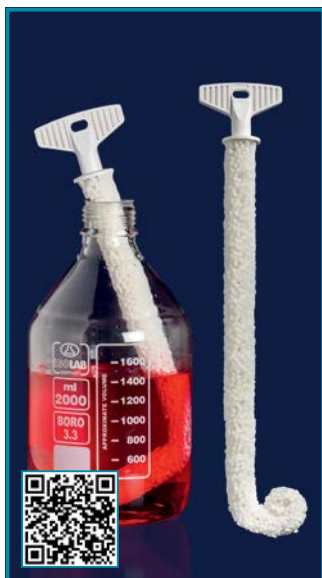

| catalogue number | pack quantity |
|------------------|---------------|
| 071.05.001 | 1 piece |

LABORATORY BRUSH - "round head"



➤ Specially recommended for all labware with cylindrical form such as cylinders, beakers, vertical tanks and other similar flasks.

➤ Guarantees perfect cleaning with it's spherical cleaning brush part that touches every surface and corner of labware's interior.

| catalogue number | brush size | brush diameter | total length | pack quantity |
|------------------|------------|----------------|--------------|---------------|
| 071.05.002 | short | 60 mm | 350 mm | 1 piece |
| 071.05.003 | long | 70 mm | 400 mm | 1 piece |

LABORATORY BRUSH - "for tubings"

➤ Specially recommended for hoses, tubings with diameter from 12 mm to 25 mm.

➤ Perfectly adapts to the rounding of the tube and flexible long handle enables even the round labware can be cleaned effectively.

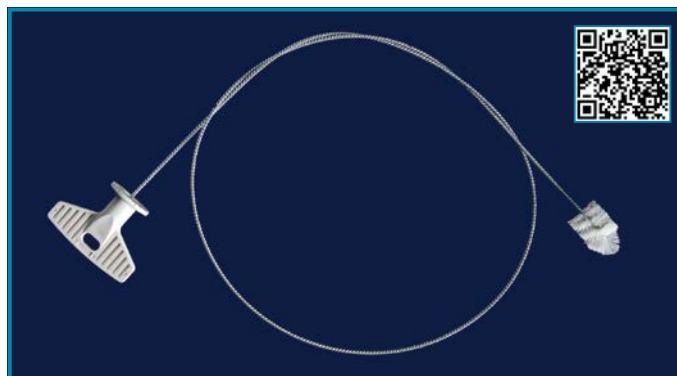

| catalogue number | brush diameter | total length | pack quantity |
|------------------|----------------|--------------|---------------|
| 071.05.005 | 20 mm | 1200 mm | 1 piece |

LABORATORY BRUSH - "for tubes"

➤ Specially recommended for tubes due to the unique design which fits to all tube sizes from the smallest to the largest diameter.

➤ Consists of two parallel cleaning brush rods hold by a single head. The rods can be pulled and moved to sides.

➤ This feature enables the contact of the brush all over the interior surface of different tubes with different diameters.

➤ This tube brush with it's unique features guarantees fast and very effective cleaning of all tubes with different size and length.

| catalogue number | brush diameter | total length | pack quantity |
|------------------|----------------|--------------|---------------|
| 071.05.004 | 25 mm | 180 mm | 1 piece |





Draining racks are supplied without packs pegs.
Pegs should be ordered separately.

DRAINING RACK

- These professional draining racks cover all the cleaning demands of a modern laboratory.
- Manufactured from water resistant, sturdy polyresin thick plate for life time usage.
 - Medium size rack with 72 peg compartments
- Alternative 2 racks:
 - Large size rack with 122 peg compartments
- The collecting tray at the bottom part collects the drained water and dispenses with the help of a hose supplied as a standard to the rack.
- Supplied complete with wall mounting kit, draining hose and fixing template.
- Draining racks are supplied with 16 small and 16 large pegs. Please kindly order for more pegs separately.



The collecting tray at the bottom part collects the drained water and dispenses by a hose supplied as a standard to the rack.

| catalogue number | rack width | rack height | peg quantity | pack quantity |
|------------------|------------|-------------|--------------|---------------|
| 071.01.002 | 500 mm | 610 mm | 72 | 1 piece |
| 071.01.003 | 500 mm | 1010 mm | 122 | 1 piece |



DRAINING PEGS

- Pegs are manufactured from ABS which is extremely resistant side effects. Pegs are supplied disassembled and can easily be inserted into the related compartments on the draining rack.

| catalogue number | for flask neck diameter | peg type | peg form | pack quantity |
|------------------|-------------------------|----------|------------|---------------|
| 071.01.101 | 15 mm & more | large | triangular | 16 pieces |
| 071.01.102 | 6 mm - 15 mm | small | round | 16 pieces |



DRAINING RACK

- Manufactured from high quality, chromated steel. Double shelf design offers practical use and best draining option with all size of glasswares.

| catalogue number | dimensions (mm) | pack quantity |
|------------------|-----------------|---------------|
| 071.01.004 | 475x310x310 | 1 piece |



Committed to

Quality

Eschau - Germany

www.isolab.de

AUTOCLAVE - "vertical"

- This easy to use, desktop, vertical autoclave offers practical solutions for sterilization.
- Safe, reliable and complete sterilization is guaranteed by immersion type electrical heating elements with high thermal efficiency.
- Sterilization chamber is manufactured from single piece stainless steel of 2,5 mm thickness.
- "Over-temperature" and "over-pressure" systems ensures highest safety level during operation run cycle.
- Silicone sealing ring guarantees excellent and safe closure and prevents steam leakage offering always clean and dry environment.
- Featured with a LED screen electronic timer enabling the time control between 1 - 99 minutes.
- Operative pressure clearly visible and controllable by a pressure gauge. Also featured with buzzer type alarm function for low water level.



"Over-temperature" and "over-pressure" systems ensures highest safety level during operation cycle.

TEST INDICATOR - "for steam sterilization"

➤ Specially designed for steam sterilisation tests. Consist of a rolled paper with temperature sensitive stripes on the surface.

➤ These stripes changes color once the ambient temperature reaches steam sterilisation temperature level.

➤ Irreversible color change from pale yellow to dark brown proves that the sterilisation protocols has been successfully covered.

➤ Adhesive at the back of the rolled paper strongly adheres to paper, plastic and textile surfaces yet easily removable without leaving any trace.

➤ Slightly crepped paper surface allows easy marking by any kind of pen.



before sterilization

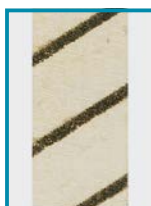

after sterilization



Featured with a LED screen electronic timer enabling the time control between 1 - 99 minutes.

| | |
|--------------------------------|---|
| catalogue no | 601.02.024 |
| external dimensions (mm) | 390 x 400 x 690 |
| chamber dimensions (mm) | Ø280 x 310 |
| chamber volume (L) | 24 |
| voltage (V) | 220 |
| frequency (Hz) | 50 / 60 |
| power (kW) | 2,0 |
| sterilizing (pressure / temp.) | 100 - 120 KPa / 121°C 200 KPa / 127°C |
| water tank capacity (lt) | 1,5 |
| water consumption / cycle (lt) | 0,4 |
| internal material | stainless steel |
| external material | stainless steel |
| safety devices | over heat protection over pressure protection leakage breaker safety valve door lock system |

| catalogue number | roll width | roll length | pack quantity |
|------------------|------------|-------------|---------------|
| 101.03.001 | 19 mm | 50 m | 1 piece |

ULTRASONIC CLEANERS - "standard"



- Offer ideal solutions for intensive and gentle cleaning of glassware, metal parts, electronic components, instruments.
- Featured with robust stainless steel vibration tank and housing with handles to carry on both sides. Tubs made of cavitation – proof stainless steel.
- Assures uniform, precision cleaning over the entire surface, and consistent cavitation that reaches and cleans even tiny crevices on the parts.
- Membrane keypad with digital LED panel for simultaneous display for set & actual temperature and set & actual time.
- Memory function keeps settings in memory for frequent and repeated operations.
- Pause function gives an option to pause and restart the operation at any desired moment.
- High heating performance ensures short warm-up period.
- Heating can be controlled up to 80°C with 1°C increments.
- Time control is possible between 1-60 minutes with 1 minute increments.
- Delivered complete with stainless steel lid and stainless steel "standard density" basket.
- Ultrasonic cleaners from 10 to 28 L are featured with a drainage valve for removal of the water from the tank.

| catalogue no | 621.05.001 | 621.05.003 | 621.05.006 | 621.05.010 | 621.05.015 | 621.05.022 | 621.05.028 |
|-----------------------|-----------------|-----------------|-----------------|-----------------|-----------------|-----------------|-----------------|
| ext. dimensions (mm) | 175 x 155 x 225 | 265 x 165 x 225 | 365 x 175 x 285 | 420 x 265 x 285 | 365 x 340 x 365 | 540 x 340 x 365 | 540 x 340 x 365 |
| tank dimensions (mm) | 150 x 138 x 65 | 238 x 138 x 100 | 302 x 152 x 150 | 302 x 239 x 150 | 325 x 295 x 150 | 502 x 298 x 150 | 502 x 298 x 200 |
| tank volume (L) | 1,1 L | 2,7 L | 5,7 L | 9,6 L | 14,5 L | 21,7 L | 27,7 L |
| ultrasonic power (W) | 60 | 120 | 180 | 240 | 360 | 360 | 480 |
| frequency (kHz) | 40 | 40 | 40 | 40 | 40 | 40 | 40 |
| heating power (W) | 60 | 180 | 300 | 300 | 500 | 600 | 600 |
| max. heating (°C) | 80 | 80 | 80 | 80 | 80 | 80 | 80 |
| heating accuracy (°C) | ± 1 | ± 1 | ± 1 | ± 1 | ± 1 | ± 1 | ± 1 |
| time control (min) | 1 - 60 | 1 - 60 | 1 - 60 | 1 - 60 | 1 - 60 | 1 - 60 | 1 - 60 |
| drainage valve | N/A | N/A | N/A | yes | yes | yes | yes |
| standard accesories | basket & lid | basket & lid | basket & lid | basket & lid | basket & lid | basket & lid | basket & lid |



Ultrasonic cleaners from 10 to 28 L featured with a drainage valve for removal of dirty water.



Featured with sturdy, stainless steel handles for safe and easy hold of the ultrasonic bath.

cleaning & safety & protection & sterilization



ULTRASONIC CLEANERS "with sweep & degass & pulse functions"

- These ultrasonic cleaners are features with "sweep", "degass" and "pulse" functions. Most specks are similar to standard ultrasonic cleaners.
- They also offer ideal solutions for intensive and gentle cleaning of glassware, metal parts, electronic components, instruments.
- Featured with robust stainless steel vibration tank and housing with handled to carry on both sides. Tubs made of cavitation - proof stainless steel.
- Assures uniform, precision cleaning over the entire surface, and consistent cavitation that reaches and cleans even tiny crevices on the parts.
- Memory function keeps settings in memory for frequent and repeated operations.
- Pause function gives an option to pause and re-start the operation at any desired moment.
- High heating performance ensures short warm-up period. Heating can be controlled up to 80°C with 1°C increments.
- Time control is possible between 1-60 minutes with 1 minute increments.

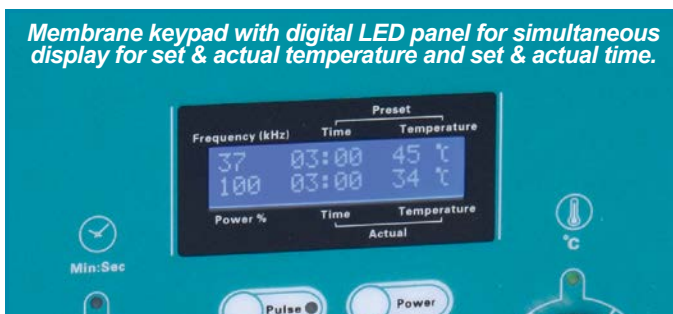

| catalogue no | 621.06.003 | 621.06.006 | 621.06.010 |
|-----------------------|--------------|--------------|--------------|
| ext. dimensions (mm) | 265x165x225 | 365x175x285 | 420x265x285 |
| tank dimensions (mm) | 238x138x100 | 302x152x150 | 302x239x150 |
| tank volume (L) | 2,7 L | 5,7 L | 9,6 L |
| ultrasonic power (W) | 160 | 240 | 320 |
| frequency (kHz) | 37 | 37 | 37 |
| heating power (W) | 150 | 270 | 310 |
| max. heating (°C) | 80 | 80 | 80 |
| heating accuracy (°C) | ± 1 | ± 1 | ± 1 |
| time control (min) | 1 - 60 | 1 - 60 | 1 - 60 |
| drainage valve | N/A | N/A | yes |
| standard accesories | basket & lid | basket & lid | basket & lid |

ULTRASONIC CLEANER DETERGENT



- Higly effective special cleaner for cleaning items in ultrasonic baths intensively.
- Removes distillation deposits, tars, grease, resins, adhesives, fats, oils, metal oxides, mineral dirt and similar soiling without leaving traces only with consumption of less than 2 % of the tank volume.
- Supports ultrasonic cleaning process, ideal for washing operations which are normally too difficult for ultrasonics alone.
- Extremely gentle on ware with almost neutral pH value. Fully water soluble, low-foaming, low phosphate content, non-combustible, no gas formation, non-toxic, biodegradable.
- Although can be used cold water, using in hot water intensifies and accelerates the cleaning effect.

| catalogue number | pack specs | pack quantity |
|------------------|------------|---------------|
| 621.01.101 | PP bottle | 1 L |

cleaning & safety & protection & sterilization



BRUSH "for intensive cleaning"

- Specially recommended for all applications which require intensive cleaning.
- Brush part consists a mixture of natural hair and very soft bristles providing long lasting trouble free life cycle.
- Ergonomic handle offers the best grip option.
- Can also be used for cleaning larger surfaces such as benches, floor.

| catalogue number | pack quantity |
|------------------|---------------|
| 071.06.001 | 1 piece |



BRUSH "for dish washing"

- Specially recommended for all applications such as dish washing and intensive cleaning of large surfaces.
- Brush part consists several layers of sponges with different density and also a scrubbing layer at the bottom line.
- Handle offers the best grip option.

| catalogue number | pack quantity |
|------------------|---------------|
| 071.06.002 | 1 piece |



WIPES - "microfibre"

- Manufactured from microfibre textile with high tensile strength with 300 x 400 mm dimensions.
- Specially recommended for lifting and trapping dirt from surfaces for fast and efficient cleaning. No chemicals are required during cleaning.
- Absorbs and retains up to 8 times its weight. Can be washable hundreds of times without getting tired.
- Supplied as two wipes: one for glass surfaces, the other for general use.

| catalogue number | pack quantity |
|------------------|---------------|
| 071.07.003 | set of 2 |

TISSUES - "cellulose" - "paper"

- Manufactured from non-chlorine bleached cellulose as double ply sheets with 195 x 195 mm dimensions.
- Ultra soft, chemically inert, highly absorbent and low lint cellulose offers the best reliable results.
- Specially recommended for wiping and cleaning of labware and also for other use such as cleaning pipettes and slides, wiping small amounts of liquids etc.
- Supplied in a handy dispenser box for hygienic storage and easy removal.

| catalogue number | pack quantity |
|------------------|---------------|
| 080.65.002 | 100 pieces |



CLEANING TOWEL

- Manufactured from pure cellulose with high degree of water absorption.
- Offers cost effective solutions to other alternatives.
- High capacity water absorption level guarantees multi-usage of these towels.
- Cut and packed according to the interior dimensions of the towel dispenser.

| catalogue number | towel dimensions | pack quantity |
|------------------|------------------|---------------|
| 080.65.004 | 230 x 220 mm | 200 pieces |



TOWEL DISPENSER

- Designed to be used with paper towel dispensers. Can carry 200 towels at one time.
- Paper towels can be pulled from the bottom part for fast and easy dispense.
- Acrylic front panel enables visual control of the towel quantity.
- Can be easily mounted on the wall for practical use.

| catalogue number | dimensions | pack quantity |
|------------------|--------------------|---------------|
| 080.67.001 | 266 x 287 x 107 mm | 1 piece |



TRAYS - "polypropylene"

- Manufactured from polypropylene for multi-purpose use. Injection moulded as one piece, durable and featured with a strong rim around the body.
- Usable with food-stuff, hygienic and easy to clean. Easily stackable for reducing storage space.

| catalogue number | base dimensions | height | pack quantity |
|------------------|-----------------|--------|---------------|
| 062.40.901 | 183 x 127 mm | 50 mm | 1 piece |
| 062.40.902 | 255 x 180 mm | 60 mm | 1 piece |
| 062.40.905 | 355 x 245 mm | 70 mm | 1 piece |



TRAYS - "stainless steel"

- Manufactured from high quality, chemical and corrosion resistant AISI 304 grade stainless steel for multipurpose use.
- Robust and seamless construction guarantees long life cycle. Smooth polished surfaces provide fast and easy cleaning.

| catalogue number | base dimensions | height | pack quantity |
|------------------|-----------------|--------|---------------|
| 062.42.910 | 400 x 500 mm | 50 mm | 1 piece |
| 062.42.915 | 450 x 600 mm | 50 mm | 1 piece |
| 062.42.920 | 500 x 700 mm | 50 mm | 1 piece |



BUCKET

- Buckets with lid are manufactured from polypropylene. Featured with a sturdy carry handle for easy lift and with a lid for complete closure of the bucket.

| catalogue number | volume | top dia. x height | pack quantity |
|------------------|--------|-------------------|---------------|
| 062.60.901 | 1 L | 120 x 122 mm | 10 pieces |
| 062.60.902 | 2 L | 165 x 138 mm | 10 pieces |
| 062.60.903 | 3 L | 190 x 132 mm | 10 pieces |
| 062.60.905 | 5 L | 210 x 171 mm | 10 pieces |
| 062.60.909 | 9 L | 259 x 226 mm | 10 pieces |
| 062.60.918 | 18 L | 310 x 275 mm | 10 pieces |

| catalogue number | volume | top dia. x height | pack quantity |
|------------------|--------|-------------------|---------------|
| 062.61.909 | 9 L | 265 x 250 mm | 1 piece |
| 062.61.914 | 14 L | 302 x 295 mm | 1 piece |



SAFETY BOXES

- Manufactured from polypropylene according to UN3291 standard. Labelled according to international standards. Resistant to solvents. Thick wall offers puncture resistance to all means.
- Ideal to safe disposal of contaminated products such as needles, syringes, lancets etc.
- For safety reasons the main lid is permanently locked and sealed once pressed on the body. Lid provided with a built-in flat opening for waste entry having a temporary and permanent closing system.

| catalogue number | volume | dimensions | pack quantity |
|------------------|--------|--------------------|---------------|
| 062.80.901 | 1.3 L | 70 x 115 x 165 mm | 1 piece |
| 062.80.903 | 3.0 L | 180 x 215 x 110 mm | 1 piece |
| 062.80.905 | 5.0 L | 175 x 215 x 185 mm | 1 piece |
| 062.80.912 | 12.0 L | 225 x 270 x 265 mm | 1 piece |
| 062.80.925 | 25.0 L | 270 x 300 x 435 mm | 1 piece |

cleaning & safety & protection & sterilization

GOGGLE



➤ Comfortable, ergonomically designed goggle offers unrestricted 180° panoramic visibility. Also suitable for wearing over prescription spectacles.

➤ Ultra clear, scratch-proof, anti-fog visor guarantees very high mechanical stability.

➤ Provides a modern styling in combination with comfort. Offers supreme wearing comfort due to the light body.

➤ Can be adjusted quickly providing reliable all-round protection. Adapts to individual face curvature providing complete side protection

| catalogue number | pack quantity |
|------------------|---------------|
| 080.40.007 | 1 piece |



Additional ventilation via integrated air channels enables optimal indirect ventilation ensuring mist-free usage.



SAFETY SPECTACLES



➤ Manufactured from ultra clear, impact resistant, UV protected polycarbonate according to CE EN166 standard.

➤ Sporty and modern design with high mechanical strength.

➤ Featured with a clear scratch-proof, anti-fog, lens with 100% UV protection.

➤ Large panorama lens offer 180° extreme broad field of vision.

➤ Offers supreme wearing comfort with 18 gram light weight.

➤ Ergonomically design and slim nose bridge offers perfect fit.

➤ Different frame colors offer visual sorting and better organising.

SAFETY SPECTACLES

➤ Manufactured from ultra clear, impact resistant, UV protected polycarbonate according to CE EN166 standard.

➤ Ergonomic design guarantees perfect fit. Large panorama lens offer 180° extremely broad field of vision.

➤ Recommended for factory visits, assembly lines and laboratory routine work. Suitable for wearing over common prescription spectacles.

➤ Guarantees full protection including eyebrow and eye sides. Offers supreme wearing comfort with 39 gram light weight.



| spectacle blue frame | spectacle purple frame | spectacle ruby frame | spectacle green frame | pack quantity |
|----------------------|------------------------|----------------------|-----------------------|---------------|
| 080.40.002B | 080.40.002P | 080.40.002R | 080.40.002G | 1 piece |

| spectacle clear lens | pack quantity |
|----------------------|---------------|
| 080.40.003 | 1 piece |

SAFETY SPECTACLES



➤ Manufactured from ultra clear, impact resistant, UV protected polycarbonate according to CE EN166 standard. Ergonomic design guarantees perfect fit.

➤ Featured with a clear scratch-proof, anti-fog, lens with 100% UV protection. Guarantees full protection of eyes including eyebrow and eye sides.

➤ Offers supreme wearing comfort with 27 gram light weight. Large panorama lens offer 180° broad field of vision.

➤ 30 degree up/down movable side arm also guarantees the optimum lens angle adjustment for the best configuration.

➤ Featured with side arm length adjustment with integrated stop lock for perfect fit of the spectacle to the face and optimum coverage of the eyes.

➤ Soft silicone ear pads at the side arms offer supreme wear comfort and pressure-free fit.

spectacle
clear lens

080.40.004

pack
quantity

1 piece



spectacle
with clear lens

080.40.001

spectacle
with dark lens

080.40.011

SAFETY SPECTACLES



➤ Manufactured from ultra clear, impact resistant, UV protected polycarbonate according to CE EN166 standard.

➤ Featured with a clear scratch-proof, anti-fog, lens with 100% UV protection.

➤ Offers modern styling and very high mechanical strength and full protection to eyes with wide curved lens.

➤ Ergonomic design guarantees perfect fit. Large panorama lens offer 180° extremely broad field of vision. Offers supreme wearing comfort with 27 gram light weight.

➤ 30 degree up/down movable side arm also guarantees the optimum lens angle adjustment for the best configuration.

➤ Featured with side arm length adjustment with integrated stop lock for perfect fit of the spectacle to the face.

➤ Soft silicone ear pads at the side arms offer supreme wear comfort and pressure-free fit. Soft silicone nose loops prevent slipping and ensure comfortable sit on the nose.

➤ Spectacle with a dark lens offers UV 400 protection against direct sunlight exposure.

➤ Spectacle with a yellow lens offers UV 254 protection against laser and UV light.

spectacle
with yellow lens

080.40.021

pack
quantity

1 piece

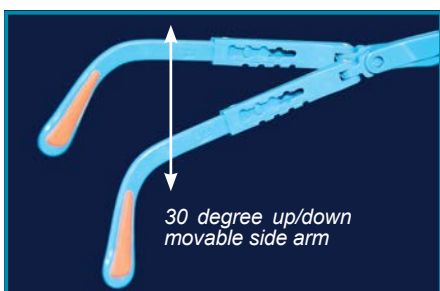

30 degree up/down movable side arm also guarantees the optimum lens angle adjustment.

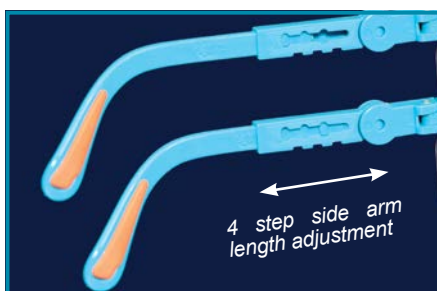

3 step side arm length adjustment for perfect fit to the face and optimum coverage of the eyes.



Soft silicone ear pads at the side arms offer supreme wear comfort and pressure-free fit.

cleaning & safety & protection & sterilization



SAFETY SHIELD

- Manufactured from polypropylene with integrated forehead safety cover.
- Provides excellent protection of full face against chemical splashes and flying objects.
- 1,5 mm thick fold-up protective visor manufactured from ultra clear acrylate with extra clear vision in all angles.
- Can be worn on the masks, goggles and spectacles. Ultra light weight guarantees full comfort.
- Rotating fastener for easy and fast adjustment to individual head shapes and sizes.
- Variable lift-up mechanism with locking option at any desired position and angle offers practical use.
- Soft sweat band eliminates sweat drops and offers comfortable use.

catalogue
number

080.40.010

pack
quantity

1 piece

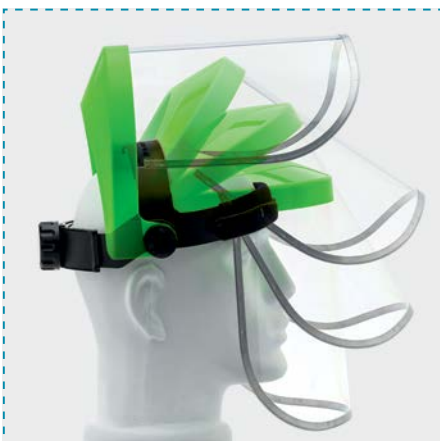

Variable lift-up mechanism with locking at any position. Soft vinyl band offers comfortable use.

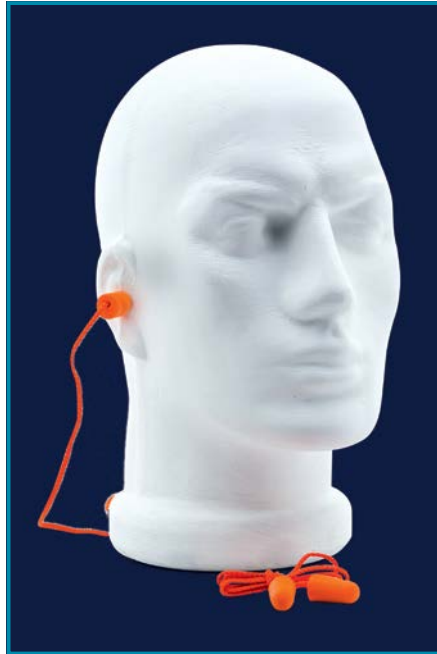

EAR PLUGS

- Manufactured from non-allergic, very soft, comfortable to wear PU foam with excellent sound insulation.
- Unique design offers wearing comfort even when worn extended hours.
- Optimised bell shape guarantees perfect fit even to ears with smaller auditory canals with a simple insertion.
- Once used seals the ear channel without the risk of slipping out.
- Featured with a cord fixing two plugs each other reducing the risk of loss. Easy to store when not in use.

catalogue
number

069.04.001

pack
quantity

set of 2



Illumination angle is adjustable in all directions by swivel mechanism.



EAR MUFF

- Low weight ear muff consists of two part ear pad with well ventilated and soft cushions.
- Offers perfect noise isolation and protection in extremely noisy environments.
- Steel suspensions headband system resistant to bending and providing comfortable pressure on ears.
- Quick-click adjustment enables headbands to adapt quickly to all head shapes and sizes and offers exceptional wearing comfort.
- Ear pads can be folded when not in use for protection against dust and other effects.

catalogue
number

069.04.002

pack
quantity

1 piece

LED LIGHT SOURCE

- Offers perfect illumination at dark working environments.
- Featured with a side clamp for easy and practical attachment of the light source to spectacles.
- Supplied with easily replaceable batteries with long life cycle.

catalogue
number

069.03.005

pack
quantity

1 piece

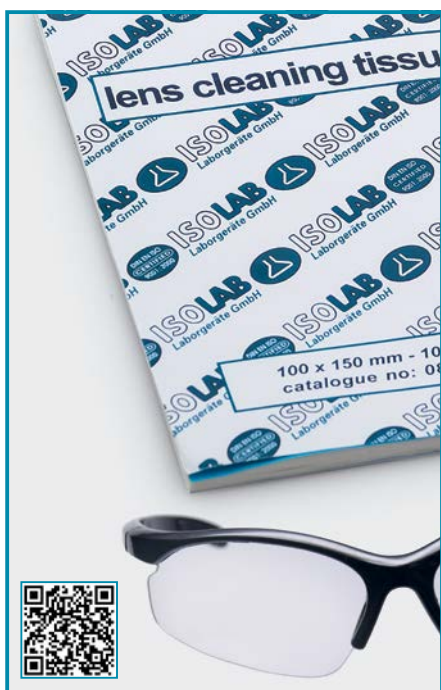

CLEANING TISSUES

- Manufactured from very thin best quality paper based on 100 % manile fibre. Cut with dimensions 100 x 150 mm.
- Guarantees fast and very effective cleaning of spectacles, goggles, microscope objectives, binoculars and all similar optical lens involved items.
- Never leaves any fibers or dust on the cleaned surface.
- These papers never scratches and damages the surfaces. They guarantee non-abrasive cleaning.
- Supplied in a handy booklet of 100 tissue sheet for hygienic storage and for easy dispensing.

| catalogue number | dimensions | pack quantity |
|------------------|--------------|---------------|
| 080.65.003 | 100 x 150 mm | 1 booklet |



CABINET

- Manufactured from crystal clear acylic with excellent field of vision for storing spectacles.
- Guarantees safe storage of spectacles from dust and other enviromental effects.
- Also can be used to store similar size of other type objects. 5 shelves with generous openings provide easy and safe access to partitions.
- Cover is featured with easy opening hinged lid. Magnetic clasp on the lid guarantees safe closure of the cabinet.
- Once opened, the lid stands open and enables easy filling and dispensing.
- Delivered with necessary attachment screws to be mount to the wall.



ULTRASONIC BATH

- Designed for intensive and gentle cleaning of small size objects such as spectacles.
- Assures uniform, precision cleaning over the entire surface.
- Featured with a digital LED panel for set & actual time.

| | |
|----------------------|--------------------|
| catalogue no | 621.08.001 |
| ext. dimensions (mm) | 205 x 145 x 125 |
| tank dimensions (mm) | 168 x 110 x 52 |
| tank volume (L) | 0,6 |
| voltage (V) | 110 - 220 |
| frequency (Hz) | 50 / 60 |
| ultrasonic power (W) | 35 |
| frequency (kHz) | 42 |
| time control (sec) | 60/120/180/240/300 |

ANTIFOG SET

- Offers 24 hour protection against fogging and keeps the spectacles always with a clear visibility.
- Set consists of 1 x spray unit with antifogging solution and 1 x cleaning ped.
- The application is very simple and effective. Just press the vaporisation button of the spray unit and spread of the antifogging solution all over the spectacle lens.
- Than wipe and clean the lens with the help of the provided cleaning ped.

| catalogue number | pack quantity |
|------------------|---------------|
| 080.40.102 | 1 piece |



| catalogue number | shelf quantity | external dimensions | pack quantity |
|------------------|----------------|---------------------|---------------|
| 080.40.101 | 5 | 110x260x400 mm | 1 piece |



EYE WASH BOTTLES - "standard size"



➤ Accidents can and do happen anytime. Every laboratory should have an emergency eye wash station for immediate access.

➤ Body manufactured from flexible and easy to squeeze polyethylene. The spray head and other parts manufactured from polystyrene.

➤ The spray head fits securely around the eye socket to hold eyelid in an open position during application.

➤ Eye wash bottle with 660 ml volume capacity provides a soft, broad and effective spray with a single action.

➤ The spray head has a perforated plate to break up the stream providing a gentle spray to the eye.

➤ A capped air vent valve prevents drawback of the contaminated eye wash back to the reservoir.

➤ Snap-on cap covers the spray head in a hygienic way and guarantees perfect protection of inside from dust and other environmental effects.

➤ Contaminated used solution exits through a drain tube which rotates in any direction.

➤ Eye wash bottle filled with sterile saline solution

➤ Alternative 2 bottles:

➤ Eye wash bottle filled with sterile neutralisation solution

| catalogue number | solution descriptions | pack quantity |
|------------------|---|---------------|
| 069.03.660 | with 0,9 % saline rinsing solution | 1 piece |
| 069.04.660 | with 4,9 % phosphate buffer neutralisation solution | 1 piece |

069.05.660 / empty bottle without solution / 1 piece



Eye wash bottle provides a soft, broad and excellent, effective spray with a single action.



Snap-on cap covers the spray head in a hygienic way and guarantees perfect protection of inside.



Bottle can be used also even when the injured person is lying down with the help of a sliding valve.



The spray head has a perforated plate to break up the stream providing a gentle spray to the eye.



The spray head fits securely around the eye socket to hold eyelid in an open position during application.



Contaminated used solution exits through a drain tube which rotates in any direction with 180 degree.

EYE WASH BOTTLES - "compact size"

- Manufactured as a personal eye wash bottle for emergency use.
- Ideal size for persons being frequently present in different risky working areas.
- Compact size with 175 ml volume capacity offers easy carry in a jacket pocket.
- The spray head fits securely around the eye socket to hold eyelid in an open position during application.
- Eye wash bottle provides a soft, broad and effective spray with a single action.
- The spray head has a perforated plate to break up the stream providing a gentle spray to the eye.
- A capped air vent valve prevents drawback of the contaminated eye wash back to the reservoir.
- Snap-on cap covers the spray head in a hygienic way and guarantees perfect protection of inside from dust and other environmental effects.
- Contaminated used solution exits through a drain tube which rotates in any direction.

➤ Eye wash bottle filled with sterile saline rinsing solution

➤ Alternative 2 bottles:

➤ Eye wash bottle filled with sterile neutralisation solution

| catalogue number | solution descriptions | pack quantity |
|------------------|---|---------------|
| 069.03.175 | with 0,9 % saline rinsing solution | 1 piece |
| 069.04.175 | with 4,9 % phosphate buffer neutralisation solution | 1 piece |

069.05.175 / empty bottle without solution / 1 piece

sterile saline rinsing solution

- Sterile saline rinsing solution contains 0,9% sodium chloride. Helpful in rinsing away dust, debris and other harmful irritants.
- Does not involve any side effects since the pH value is similar to that of human tears.
- Prevents the foreign bodies from sticking into the eye and causing serious harm.
- Does not contain pathogens that could cause infection, and will not damage eye or skin tissue during prolonged flushing.

sterile neutralisation solution

- When acids and alkalis contact the eyes or skin damage can start immediately.
- pH neutralising solution contains a sterile 4,9% phosphate buffer solution.
- Helpful in rinsing and neutralisation of acids and alkalis and other chemical contaminants to a harmless level in a very short time period.
- It is recommended to rinse the eye with saline solution after treatment with pH neutralisation solution.



Compact size offers easy carry in a jacket pocket.

BOTTLE STAND - "for eye wash bottle"



- For keeping eye wash bottles always "ready-for-use" stage.
- Keeps the bottle stable at his nest and guarantees easy and fast access to the bottle.
- Featured with a mirror and "how-to-use" instructions printed on the body.
- User looks directly into a mirror during rinsing.
- Supplied with necessary screw set for mounting on the wall.

| catalogue number | pack quantity |
|------------------|---------------|
| 069.05.001 | 1 piece |

User looks directly into a mirror during rinsing. Focusing on the mirror with the eye lid open helps overcome the blinking reflex.

cleaning & safety & protection & sterilization



GLOVES - "nitrile" - "0,06 mm standard thickness"

- Manufactured pure nitrile free from phthalate softeners and latex proteins which cause allergy to the skin.
- Provides a standard thickness of 0,06 mm which is recommended for daily laboratory use.
- Classified as CE category 1. Tested in accordance with EN420:2003 standard.
- Provided with AQL 1,5 offering the highest level of protection according to EN374-2:2003 against penetration of microorganisms.
- 40 % more stronger and 60 % leaner than latex gloves.
- Provides full protection against wide range of chemicals including cytotoxic drugs.
- Easy to wear. Unique production techniques offer excellent mechanical strength providing multi-use options.
- Excellent fit to the hands guarantees maximum comfort.
- Slightly textured finger parts guarantee excellent grip option.

| catalogue number | size | color | AQL | length | thickness | pack quantity |
|------------------|--------------|--------|------|--------|-----------|---------------|
| 080.15.001 | Small (7) | purple | 1.50 | 240 mm | 0,06 mm | 100 pieces |
| 080.15.002 | Medium (8) | purple | 1.50 | 240 mm | 0,06 mm | 100 pieces |
| 080.15.003 | Large (9) | purple | 1.50 | 240 mm | 0,06 mm | 100 pieces |
| 080.15.004 | X Large (10) | purple | 1.50 | 240 mm | 0,06 mm | 100 pieces |

GLOVES - "nitrile" - "0,12 mm extra thickness"

- Manufactured pure nitrile free from phthalate softeners and latex proteins which cause allergy to the skin.
- Provides extra thickness of 0,12 mm which is recommended for daily laboratory use.
- Thick gloves are specially designed for life science, biomedical research, forensic science and drug handling applications.
- **Extra thickness guarantees extra safety.**
- Classified as CE category 1. Tested in accordance with EN420:2003 standard.
- Provided with AQL 1,5 offering the highest level of protection according to EN374-2:2003 against penetration of micro-organisms.
- 40 % more stronger and 60 % leaner than latex gloves.
- Provides full protection against wide range of chemicals including cytotoxic drugs.
- Easy to wear. Unique production techniques offers excellent mechanical strength providing multi-use options.
- Excellent fit to the hands guarantee maximum comfort. Slightly textured finger parts guarantee excellent grip option.

| catalogue number | size | color | AQL | length | thickness | pack quantity |
|------------------|--------------|-------|------|--------|-----------|---------------|
| 080.16.001 | Small (7) | blue | 1.50 | 240 mm | 0,12 mm | 100 pieces |
| 080.16.002 | Medium (8) | blue | 1.50 | 240 mm | 0,12 mm | 100 pieces |
| 080.16.003 | Large (9) | blue | 1.50 | 240 mm | 0,12 mm | 100 pieces |
| 080.16.004 | X Large (10) | blue | 1.50 | 240 mm | 0,12 mm | 100 pieces |



how to measure the right glove size?



- You have to select the right size of glove for your hands for your comfort.
- How you will select the right size of your glove? Measure the circumference of your dominant hand just below the fingers excluding the thumb. Compare the measurement to the size chart below to find your glove size.

| | | | | | |
|-----------|-----------|-----------|------------|-------------|-------------|
| XS | S | M | L | XL | XXL |
| (6" - 7") | (7" - 8") | (8" - 9") | (9" - 10") | (10" - 11") | (11" - 12") |

GLOVES - "for safe handling"

➤ Manufactured from light weight 100 % cotton for multi-use. Unique design provides both left and right handed use.

➤ Easy to wear. Soft and flexible texture offers full comfort during use. Thick yet stretchable. Protects the sensitive skin.

➤ Makes unlined gloves easier to pull or to wear. Also prevents

from moderate levels of cold and heat. They are machine washable.

| catalogue number | total length | pack quantity |
|------------------|--------------|---------------|
| 080.13.001 | 260 mm | 1 pair |

**GLOVES - "for cold protection"**

➤ Economical and practical glove specially designed to work in cold environments.

➤ Recommended to be used in cold treatment plants, handling dry ice, working with coolents.

➤ Offers full protection very against even cold temperatures such as -140°C.

➤ Easy to wear. Soft and flexible texture offers full comfort during use. Thick yet stretchable. Protects the sensitive skin.

➤ The outer part of the glove is covered with a heat repellent leather. While the inner part is featured with soft and flexible protective textile.

➤ Even working at very low temperatures with extended hours it still remains flexible.

| catalogue number | total length | pack quantity |
|------------------|--------------|---------------|
| 080.10.201 | 450 mm | 1 pair |

**GLOVES - "for cold protection"**

➤ Specially designed to work in hazardous ultra-cold environments. Recommended to be used in cold treatment plants, handling dry ice, working with coolents. Not immersion in liquid nitrogen.

➤ Multi-layer construction provides light weight and full comfort during use. State-of-art material is breathable and stays always comfortable and dry.

➤ Offers full protection against even very cold temperatures such as -160°C. The innovative design offers superior thermal protection and maximum level of flexibility.

➤ Even working at very low temperatures with extended hours it still remains flexible.

| catalogue number | glove length | pack quantity |
|------------------|--------------|---------------|
| 080.10.101 | 450 mm | 1 pair |

GLOVES - "for heat protection"

➤ Manufactured from soft, flexible, heat resistant pliant terry cotton material.

➤ Easy to wear. Soft and flexible texture offers full comfort.

➤ The upper part is covered with a heat repellent material. While the palm part is manufactured from heat resistant soft and flexible leather.

➤ Offers maximum isolation and protection up to for limited time 250°C when working with autoclaves and muffle furnaces.

➤ Guarantees a long life cycle since they can be machine washable.

| catalogue number | total length | pack quantity |
|------------------|--------------|---------------|
| 080.11.001 | 380 mm | 1 pair |

cleaning & safety & protection & sterilization



GLOVES - "nitrile" - "for chemical protection"

- ▶ Manufactured from pure nitrile free from phthalate softeners and latex proteins.
- ▶ Classified as CE category III they can be used both at laboratories and industry.
- ▶ Offers excellent protection against alcohols, oils, greases, and hydrocarbons.
- ▶ Provide superior mechanical resistance against abrasion and perforation.
- ▶ Excellent fit and flexible texture offers full dexterity and comfort during use.
- ▶ Cotton flock liner inside the glove absorbs moisture and prevents sweating during use.
- ▶ Slightly textured fingers and palm guarantees excellent grip.

| catalogue number | size | length | thickness | internal finish | external finish | pack quantity |
|------------------|------|--------|-----------|-----------------|-----------------|---------------|
| 080.21.007 | 7 | 320 mm | 0,38 mm | flocked | embossed | 1 pair |
| 080.21.008 | 8 | 320 mm | 0,38 mm | flocked | embossed | 1 pair |
| 080.21.009 | 9 | 320 mm | 0,38 mm | flocked | embossed | 1 pair |



GLOVES - "nitrile" - "for chemical protection"

- ▶ Manufactured from pure nitrile free from phthalate softeners and latex proteins.
- ▶ Classified as CE category III they can be used both at laboratories and industry.
- ▶ Offers excellent protection against alcohols, oils, greases, and hydrocarbons.
- ▶ Provide superior mechanical resistance against abrasion and perforation.
- ▶ Excellent fit and flexible texture offers full dexterity and comfort during use.
- ▶ Cotton flock liner inside the glove absorbs moisture and prevents sweating during use.
- ▶ Slightly textured fingers and palm guarantees excellent grip.

| catalogue number | size | length | thickness | internal finish | external finish | pack quantity |
|------------------|------|--------|-----------|-----------------|-----------------|---------------|
| 080.22.007 | 7 | 355 mm | 0,85 mm | flocked | embossed | 1 pair |
| 080.22.008 | 8 | 355 mm | 0,85 mm | flocked | embossed | 1 pair |
| 080.22.009 | 9 | 355 mm | 0,85 mm | flocked | embossed | 1 pair |



GLOVES - "neopren" - "for chemical protection"

- ▶ Manufactured from polychloroprene which can cause allergy to the skin.
- ▶ Classified as CE category III they can be used both at laboratories and industry.
- ▶ Offer protection against semi-concentrated acids, concentrated bases, concentrated saline solutions, glycerol, solvents, alcohols, fats and oils.
- ▶ Excellent fit and flexible texture offers full dexterity and comfort during use.
- ▶ Cotton flock liner inside the glove absorbs moisture and prevents sweating during use.
- ▶ Slightly textured fingers and palm guarantees excellent grip and handling option both for dry, wet and oily products.

| catalogue number | size | length | thickness | internal finish | external finish | pack quantity |
|------------------|------|--------|-----------|-----------------|-----------------|---------------|
| 080.23.007 | 7 | 310 mm | 0,55 mm | flocked | embossed | 1 pair |
| 080.23.008 | 8 | 310 mm | 0,55 mm | flocked | embossed | 1 pair |
| 080.23.009 | 9 | 310 mm | 0,55 mm | flocked | embossed | 1 pair |



GLOVES - "for thermal resistance"

- ▶ Manufactured from nitrile foam. Suitable for handling hot objects up to 125°C. Also ideal for handling of materials after heat.
- ▶ Classified as CE category II they can be used both at laboratories and industry.
- ▶ Thin anatomical shape ensures dexterity. Offers excellent fit to the hands.
- ▶ Nitrile spheres at the palm and finger parts guarantees perfect insulation with excellent grip option.

| catalogue number | size | length | internal finish | external finish | pack quantity |
|------------------|------|--------|-----------------|-----------------|---------------|
| 080.26.007 | 7 | 280 mm | flocked | dotted | 1 pair |
| 080.26.009 | 8 | 280 mm | flocked | dotted | 1 pair |
| 080.26.010 | 9 | 280 mm | flocked | dotted | 1 pair |



GLOVES - "silicone"

- Manufactured from best quality natural silicone resistant both to heat and cold.
- Guarantees excellent chemical and temperature resistance between -60°C to +170°C.
- Very flexible and slip-proof characteristics guarantee easy and safe grip of all kinds of flasks and vessels

| catalogue number | glove type | pack quantity |
|------------------|---------------|---------------|
| 080.18.001 | for 5 fingers | 1 piece |
| 080.18.002 | full hand | 1 piece |



HEAT PROTECTOR



- Manufactured from natural silicone for protecting fingers. Resistant both to heat and cold.
- Offers excellent chemical and temperature resistance between -60°C to +170°C.
- They offer a practical and economical alternative to gloves.
- Very flexible and slip-proof characteristics guarantee easy and safe grip of all kinds of flasks and vessels.

| catalogue number | glove type | pack quantity |
|------------------|---------------|---------------|
| 080.17.001 | for 2 fingers | 1 piece |



HEAT PROTECTOR



- Manufactured from natural silicone for protecting hands. Resistant both to heat and cold.
- Offers excellent chemical and temperature resistance between -60°C to +170°C.
- They offer a practical and economical alternative to gloves.
- Very flexible and slip-proof characteristics guarantee easy and safe grip of all kinds of flasks and vessels.

| catalogue number | glove type | pack quantity |
|------------------|---------------|---------------|
| 080.17.002 | for 5 fingers | 1 piece |

DISPENSER BOX - "for nitrile glove boxes"



- Manufactured from crystal clear acrylic with excellent field of vision for storing and dispensing nitrile glove boxes.
- Perfect tools for storing and easy dispensing 4 different sizes gloves simultaneously.
- 4 compartments with easy inserts perfectly fit to the outer dimensions of the extra thick glove boxes and holds them stable at their positions.
- Designed for use either on desk top or wall mounted.

- Delivered with necessary attachment screws to be mount to the wall.

➤ Alternative 2 box size:

- box for standard gloves
- box for thick gloves

- Box for standard gloves can also accommodate the cleaning tissue box **catalogue number 080.65.002**.

| catalogue number | dimensions | for gloves | pack quantity |
|------------------|-------------------|------------|---------------|
| 080.05.001 | 215 x 70 x 465 mm | standard | 1 piece |
| 080.05.002 | 260 x 85 x 525 mm | thick | 1 piece |



VISITORS GOWN

- Shirt collar design visitors gown without hood and without pockets. Closure is provided with snap fasteners.
- Featured with rubber fasteners at wrist. For single use. Manufactured for visitors protection at laboratories.
- Slightly porous texture of the textile guarantees air permeability and prevents sweating during use.
- Light weight. Easy to wear. Soft and flexible texture offers full comfort during use. Universal cut for fitting all body sizes.

catalogue number
080.50.001

pack quantity
1 piece

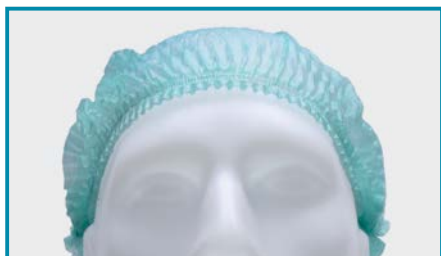

CAPS

- Manufactured from breathable, antistatic non-woven fabric. Fully protects hair from dust and other particles.

catalogue number
080.53.001

pack quantity
100 pieces



PROTECTOR SUIT

- Overall design protective suit with hood and without pockets. Closure is provided by zipper. Featured with rubber fasteners at wrist.
- For single use. Manufactured for employees and visitors protection at laboratories.
- Slightly porous texture of the textile guarantees air permeability and prevents sweating during use.
- Light weight. Easy to wear. Soft and flexible texture offers full comfort.

catalogue number
080.50.011

pack quantity
1 piece



OVER SHOES

- Manufactured from polyethylene for disposable use. Guarantees clean and sterile environment once worn on the shoes.

catalogue number
080.53.021

pack quantity
100 pieces



PROTECTOR SUITS - 5/6

- Manufactured from high density antistatic polyethylene, providing an ideal balance of protection, durability and comfort.
- Offers chemical protection according to category III (type 5 & 6). Also offers an excellent barrier against fine particles down to 1 micron size.
- Protective suit with overall design perfectly suitable for clean room areas.
- Also practical use at pharmaceutical handling and many others.

➤ Guarantees air permeability and prevents sweating during use. Repels water based liquids and aerosols.

➤ Optimised body fit provides excellent wearer comfort. Featured with hood compatible with filtering face masks.

➤ Featured with rubber fasteners at wrist and around face.

➤ Closure is provided by auto-lock zipper with flap for increased protection.

➤ Light weight. Easy to wear. Flexible texture offers full comfort during use.

| catalogue number | size | pack quantity |
|------------------|----------|---------------|
| 080.51.003 | Medium | 1 piece |
| 080.51.004 | Large | 1 piece |
| 080.51.005 | X Large | 1 piece |
| 080.51.006 | XX Large | 1 piece |



DESK PROTECTOR - "paper"

➤ A practical desk protector offering full protection of desks against spilled solutions. Quickly absorbs liquids and keep spills from spreading. Absorbs up to 750 ml/m² Their thick protective layer eliminates the risk of glass breakage in case tilt over.

➤ **Thick and very absorbent paper layer soaks the spilled liquids and protects the laboratory desks.**

➤ **Consists of 2 layers:**

➤ **Flexible, water-proof polyethylene layer prevents the spilled liquid penetration to the laboratory desk.**

➤ Supplied as a roll of 50 meters length with 46 cm width.

| catalogue number | pack quantity |
|------------------|---------------|
| 080.66.001 | 1 piece |



CHEMICAL PADS

➤ Due to their microfibre structure they provide excellent absorption capacity. Consists of 8 layer highly absorbant fibers which altogether "imprisons" the liquids and never returns back.

➤ Quickly absorbs the spills of all kinds of liquids including water based liquids, solvents, alcohols, acids and alkalis and stores them absorbed. The absorbed liquid can be extracted to be used again or to be disposed of separately.

| catalogue number | pad sheet dimensions | thickness | pack quantity |
|------------------|----------------------|-----------|---------------|
| 080.76.001 | 50 x 40 cm | 3,4 mm | 10 pieces |



DESK PROTECTORS - "cork"

➤ Manufactured from non-porous, additive free, best quality natural cork for protection of laboratory desks. Offers full protection against over heated flasks.

➤ Their thick protective layer eliminates the risk of glass breakage in case tilt over. Their light yet robust construction also significantly reduce vibration effects and noise.

| catalogue number | dimensions | thickness | pack quantity |
|------------------|--------------|-----------|---------------|
| 080.66.002 | 200 x 200 mm | 10 mm | 1 piece |
| 080.66.003 | 300 x 300 mm | 10 mm | 1 piece |

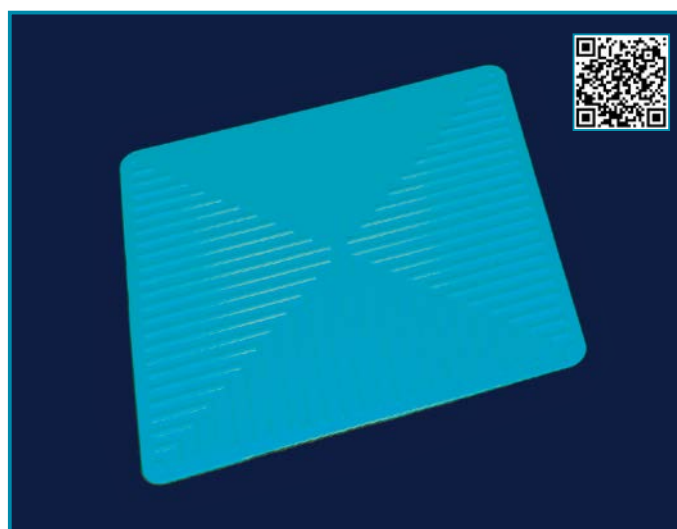

DESK PROTECTORS - "silicone"

➤ Manufactured from best quality natural silicone resistant both to heat and cold. Guarantees excellent chemical and temperature resistance between -60°C to +170°C.

➤ Very flexible and slip-proof characteristics guarantees safe hold of all flasks and also instruments. They offer full protection of desks against spilled solutions and over heated flasks.

| catalogue number | dimensions | specification | pack quantity |
|------------------|--------------|--------------------|---------------|
| 080.66.005 | 240 x 240 mm | corrugated surface | 1 piece |
| 080.66.006 | 340 x 340 mm | corrugated surface | 1 piece |

cleaning & safety & protection & sterilization



DUST MASK - "FFP-1"

- Offers protection against non-toxic harmful solid and liquid in concentrations up to 4 x OEL or 4 x APF.
- Specially recommended for calcium carbonate, china clay, cement, cellulose, cotton, sulfur, ferrous metals and foods.
- Convex design, aluminium nosepiece and adjustable fitting straps guarantee excellent fit to different face shapes.
- Light weight provides strain and fatigue free use even with extended hours.
- Inner and external layers of the mask manufactured from soft microfiber.

catalogue
number

080.41.001

pack
quantity

10 pieces



DUST MASK - "FFP-2"

- Offers protection against low-to-average toxic solids, liquids and smoke up to 12x OEL or 10 x APF.
- Addition to FFP-1 protection limits also offers protection against glass wool, mineral oils, most bacterias and fungi.
- Convex design, aluminium nosepiece and adjustable fitting straps guarantee excellent fit to different face shapes.
- Exhalation valve significantly minimise warm and humid airflow into the mask.
- Other technical properties are same with "FFP-1" dust mask.

catalogue
number

080.41.002

pack
quantity

10 pieces



DUST MASK - "FFP-3"

- Offers protection against highly toxic solids, liquids and smoke up to 50 x OEL or 20 x APF.
- Addition to FFP-2 protection limits also offers protection against heavy metal particles, smokes and odors and viruses.
- Convex design, aluminium nosepiece and adjustable fitting straps guarantee excellent fit to different face shapes.
- Exhalation valve significantly minimise warm and humid airflow into the mask.
- Other technical properties are same with "FFP-2" dust mask.

catalogue
number

080.41.003

pack
quantity

10 pieces



MASK - "half face"

- Designed and manufactured according to DIN EN 140 and AS/ NZS 1716 standards for protection of mouth and nose.
- All parts contacting with the face are manufactured from silicone.
- Cool flow valve prevents built-up heat in the mask.
- Soft silicone facepiece perfectly fits to the contours of the face without pressure points providing full comfort.
- Filter system with exchangeable cartridge filter ensures low breathing resistance.
- Supplied with a multiple gas cartridge for protection from dust, fine particles, mist, smoke, organic vapours and gases with boiling point 65°C or above.

catalogue
number

080.44.001

product
descriptions

half face mask

pack
quantity

1 piece

080.44.101

spare gas cartridge

1 piece



MASK - "full face"

- Designed and manufactured according to EN 136:1998 for protection of full face.
- Featured with anti-stretch, anti-fogging, distortion-free polycarbonate shield.
- Cool flow valve prevents built-up heat in the mask.
- Soft silicone facepiece perfectly fits to the contours of the face without pressure points providing full comfort.
- Filter system with exchangeable cartridge filter ensures low breathing resistance.
- Supplied with a multiple gas cartridge for protection from dust, fine particles, mist, toxic smoke organic or inorganic vapours and gases with boiling point 65°C or above, sulfur dioxide, acidic gasses and ammonia gas.

catalogue
number

080.45.001

product
descriptions

full face mask

pack
quantity

1 piece

080.45.101

spare gas cartridge

1 piece



*density & sedimentation
temperature & time
pH & weight measurement*

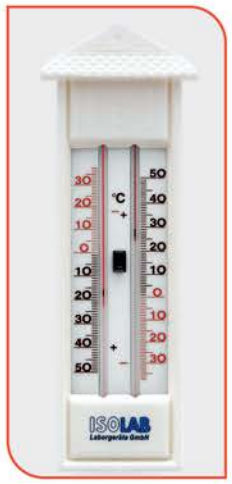

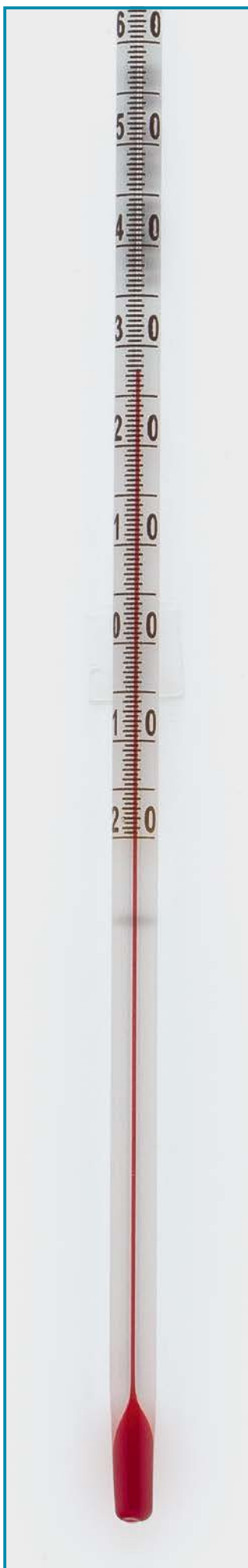

THERMOMETERS - "glass"

- Manufactured from solid stem glass rods with approximately 75 mm immersion depth.
- Printed large graduation on the front wall offers easy temperature reading.
- Large alcohol column with red color enables easy and accurate readout.
- The amber front scale of the thermometer reflects the images more clearly.

| catalogue number | operation range °C | subdivision | pack quantity |
|------------------|--------------------|-------------|---------------|
| 059.02.001 | -20/+50 | 1°C | 10 pieces |
| 059.02.002 | -20/+110 | 1°C | 10 pieces |
| 059.02.003 | -10/+150 | 1°C | 10 pieces |
| 059.02.004 | -10/+200 | 2°C | 10 pieces |

THERMOMETER CLAMP "with bosshead"

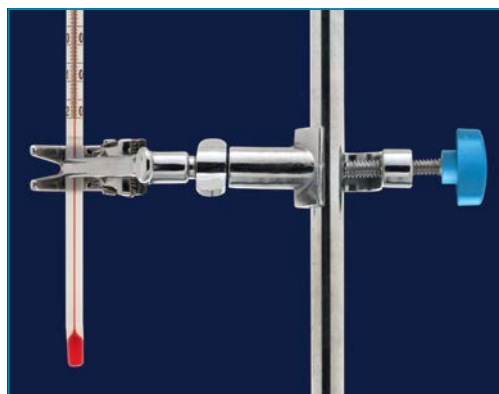

- Manufactured from high quality, corrosion resistant chromated steel for holding thermometers in the most secure way.
- Featured with a swivel bosshead which provides 360° swivel of the clamped object around their axis.
- Bosshead locking feature guarantees perfect position hold of the clamped objects.
- Fixing head featured with flexible springs offers easy insertion and extraction of the thermometers.
- Clamps can be opened and closed smoothly with a 30 mm grip diameter.

Other technical specifications can be seen at catalogue page no 51.

STAND "adjustable height"

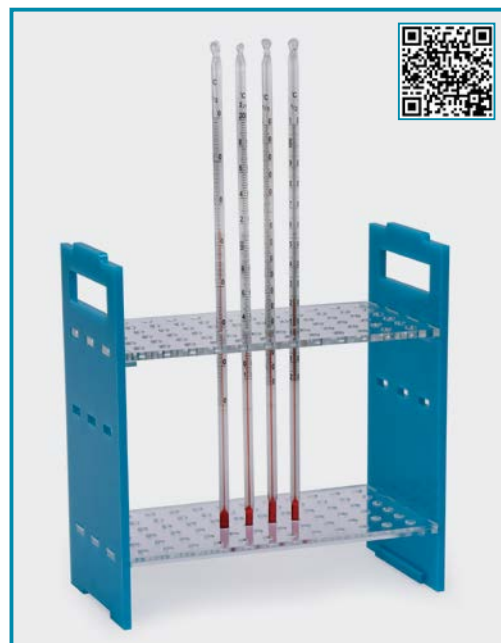

- Manufactured from acrylic for holding 72 thermometers in 12 x 6 array.

- Handles at both sides guarantee easy hold and secure grip.

- Adjustable height upper layer provides multi-use options with shorter objects.

| catalogue number | dimensions | pack quantity |
|------------------|--------------------|---------------|
| 059.05.001 | 210 x 110 x 220 mm | 1 piece |



Adjustable height upper layer provides multi use options with shorter objects.

density & sedimentation & temperature & time & pH & weight measurement



THERMOMETER
"portable"

- For temperature measurement in liquids, semi-solids. Specially offers practical solutions with foodstuff.
- Stainless steel probe with 127 mm length can easily be inserted into semi-solid samples.
- Offers temperature measurement on a large and clear 19 x 8 mm LCD display.
- Water resistant sturdy plastic housing offers long life cycle.
- Temperature measurement range is -58°F to +158°F (+/- 0,2°F) or -50°C to +300°C (+/- 0,1°C) selectively.
- °F & °C values are exchangeable by a switch control at the front panel.
- Supplied with a plastic sleeve for the protection of the measuring probe.

catalogue
number

060.01.001

pack
quantity

1 piece



THERMOMETER
"portable"

- For temperature measurement in liquids, semi-solids. Specially offers practical solutions with foodstuff.
- Stainless steel probe with 120 mm length can easily be inserted into semi-solid samples.
- Offers temperature measurement on a large and clear 34x14 mm LCD display.
- Water resistant sturdy plastic housing offers long life cycle.
- Temperature measurement range is -58°F to +572°F (+/- 2°F) or -50°C to +300°C (+/- 0,5°C) selectively.
- °F & °C values are exchangeable by a switch control at the front panel.
- Supplied with a plastic sleeve for the protection of the measuring probe.

catalogue
number

060.01.002

pack
quantity

1 piece

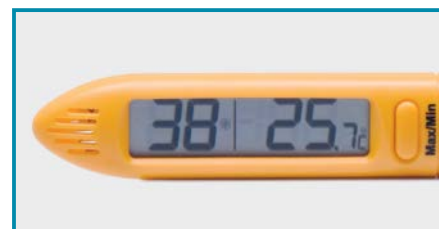

THERMOHYGROMETER
"portable"

- Pen shape, thermohygrometer is featured with a rotary probe enabling fast readings.
- Water resistant sturdy plastic housing with 138 mm length offers long life cycle.
- Featured with a clips for safe and practical use.
- Offers dual display for humidity and temperature on a large and clear 52 x 13 mm LCD display.
- Featured with maximum & minimum reading memory.
- Humidity measurement range is 20% RH – 95 %RH with +/- 3%RH accuracy.
- Temperature measurement range is 32 - 122°F (+/- 2°F) or 0 - 50°C (+/- 1°C) selectively.
- °F & °C values are exchangeable by a simple switch control at the back.

catalogue
number

060.03.002

pack
quantity

1 piece



THERMOMETER - "desk-top"

- This desk top electronic thermometer can be also used as wall hanged. With the help of two probes can be used for indoor and out-door temperature measurement simultaneously.
- The folding stand at the back housing offers a convenient angle for easy reading of the results.
- Water resistant sturdy plastic housing with 135 x 75 x 19 mm dimensions offers long life cycle.
- Offers dual display for humidity and temperature on a large and clear 51 x 41 mm LCD display.
- Featured with maximum & minimum temperature reading memory with an alarm function and date / time display.
- Temperature measurement range is -4°F to $+122^{\circ}\text{F}$ ($+/- 0,2^{\circ}\text{F}$) or -20°C to $+50^{\circ}\text{C}$ ($+/- 0,1^{\circ}\text{C}$) selectively.
- $^{\circ}\text{F}$ & $^{\circ}\text{C}$ values are exchangeable by a switch control at the front panel.

| catalogue number | pack quantity |
|------------------|---------------|
| 060.02.001 | 1 piece |



THERMOHYGROMETER - "desk-top"

- This desk top thermohygrometer can be also used as wall hanged. The folding stand at the back housing offers a convenient angle for easy reading of the results.
- Water resistant sturdy plastic housing with 109 x 70 x 19 mm dimensions offers long life cycle.
- Offers dual display for humidity and temperature on a large and clear 40 x 30 mm LCD display.
- Featured with maximum & minimum temperature reading memory with an alarm function.
- Humidity measurement range is 10% RH – 99 %RH with $+/- 5\%RH$ accuracy.
- Temperature measurement range is -58°F to $+158^{\circ}\text{F}$ ($+/- 0,2^{\circ}\text{F}$) or -50°C to $+70^{\circ}\text{C}$ ($+/- 0,1^{\circ}\text{C}$) selectively.
- $^{\circ}\text{F}$ & $^{\circ}\text{C}$ values are exchangeable by a switch control at the front panel.

| catalogue number | pack quantity |
|------------------|---------------|
| 060.03.001 | 1 piece |



THERMOMETER - "with foldable probe"

- For temperature measurement in liquids, semi-solids. Specially offers practical solutions with foodstuff.
- Featured with a foldable stainless steel probe with 85 mm length which can move 180° angle. Probe can easily be inserted into semi-solid samples.
- Offers temperature measurement on a large and clear 15 x 30 mm LCD display.
- Temperature measurement range is -58°F to $+482^{\circ}\text{F}$ or -50°C to $+250^{\circ}\text{C}$ with $+/- 0,1$ resolution.
- $^{\circ}\text{F}$ & $^{\circ}\text{C}$ values are exchangeable by a switch control inside the battery cover.
- Water resistant sturdy plastic housing offers long life cycle.

| catalogue number | pack quantity |
|------------------|---------------|
| 060.01.003 | 1 piece |



THERMOMETER - "wireless" - "max. & min."

- This thermometer is suitable both for out-door or in-door applications. Shows also time and date simultaneously.
- Maximum and minimum temperature values can also be seen by a selectable switch.
- Featured with a wireless measurement transmitter that can be used up to 60 meters (free field) to the thermometer body.
- Can display in-door and out-door temperature. °F & °C values are selectable by a switch at the front panel.
- Offers a in-door temperature measuring range from -10°C (+ 14°F) to +60°C (+140°F) with a precision of +/- 1°C (+/- 2°F)
- Offers a out-door temperature measuring range from -40°C (-58°F) to +70°C (+158°F) with a precision of +/- 1°C (+/- 2°F)
- Featured with a push buttons switches for resetting, °C or °F selection, maximum or minimum reading setting.
- Can be hanged on walls or can be used as desk-top with it's inclinable support at the back side of the body.

| catalogue number | pack quantity |
|------------------|---------------|
| 059.03.003 | 1 piece |

Featured with a wireless measurement transmitter that can be used up to 60 meters (free field) to the thermometer body.



THERMOMETER - "max. & min." - "humidity"

- Suitable both for out-door or in-door applications. Weather resistant, robust housing is featured with an inclined shelter for further protection.
 - Can measure and display in-door temperature and humidity plus out-door temperature.
- Offers 3 parameters**
- In-door temperature
 - Out-door temperature
 - %RH humidity
- Can also records and shows the maximum and minimum values of temperature and humidity selectively.
 - Offers a in-door temperature measuring range from -10°C (+14°F) to +50°C (+122°F) with a precision of +/- 1°C (+/- 2°F)
 - Offers a out-door temperature measuring range from -50°C (-58°F) to +70°C (+ 158°F) with a precision of +/- 1°C (+/- 2°F)
 - Offers a in-door humidity measuring range from 20% RH to 99% RH with a precision of +/- 5% RH.
 - Featured with push buttons switches for °C or °F selection and maximum or minimum temperature.
 - Can be hanged on walls or can stand on a bench.

| catalogue number | pack quantity |
|------------------|---------------|
| 059.03.004 | 1 piece |

**STOPWATCH - "mechanical"**

- This classical stopwatch with mechanical winding system can be used even in extreme conditions.
- Provides time counting up to 30 minutes with 0,2 second resolution.
- Chrome plated sturdy housing provides resistance to sudden impacts and guarantees long life cycle.

**STOPWATCH - "electronic"**

- Electronic stopwatch offers counting up to 59 minutes, 59 seconds with 0,01 second resolution.
- Offers long life cycle and easy use with it's water resistant sturdy plastic housing and light weight.
- **3 functions:**
 - As a time recorder
 - As a chronometer
 - As a 24 hour timer with alarm function.

**TIMER - "mechanical"**

- Mechanical timer counts up to 60 minutes with 1 minute resolution.
- No need for batteries. Just winding will be enough to start the time counting.
- A clear bell ring signals at the end of the preset time. Can be interrupted during work and reset any time.
- Can be used on bench top or also can be hanged to any smooth surface.

| catalogue number | diameter | pack quantity |
|------------------|----------|---------------|
| 055.01.001 | 50 mm | 1 piece |

| catalogue number | dimensions | pack quantity |
|------------------|-----------------|---------------|
| 055.02.001 | 63 x 76 x 20 mm | 1 piece |

| catalogue number | dimensions | pack quantity |
|------------------|-----------------|---------------|
| 056.01.001 | 60 x 60 x 34 mm | 1 piece |

**TIMER - "mechanical"**

- Mechanical timer counts up to 60 minutes with 1 minute resolution. Does not require batteries. Just winding will be enough to start the counting.
- A clear bell ring signals at the end of the preset time. Can be interrupted during work and reset any time.

| catalogue number | dimensions | pack quantity |
|------------------|-----------------|---------------|
| 055.03.001 | 93 x 75 x 59 mm | 1 piece |

**TIMER - "mechanical"**

- Mechanical timer counts up to 60 minutes with 1 minute resolution. A large screen with 150 mm diameter provides easy reading option from relatively long distances.
- Featured with a red marked area for remaining time for long distance observation.
- Can be used on bench top or also can be hanged to any smooth surface.

| catalogue number | pack quantity |
|------------------|---------------|
| 055.04.001 | 1 piece |



TIMER - "electronic"

- Electronic timer counts up to 19 hours, 59 minutes with a 4 digit display for extended hours. Also featured with count-down function.
- A clear bell ring signals at the end of the preset time.
- A large LCD screen with 32 x 12 mm dimensions provides easy reading option from relatively long distances.
- The folding stand at the back housing offers a convenient angle for easy reading. Also featured with a clip at the back side.

| catalogue number | timer dimensions | screen dimensions | pack quantity |
|------------------|------------------|-------------------|---------------|
| 056.03.001 | 53 x 62 x 12 mm | 32 x 12 mm | 1 piece |



TIMER - "electronic"

- Electronic timer counts up to 59 minutes, 59 seconds with a 4 digit display. Also featured with count-down function.
- A clear bell ring signals at the end of the preset time.
- A large LCD screen with 50 x 26 mm dimensions provides easy reading option from relatively long distances.
- The folding stand at the back housing offers a convenient angle for easy reading of the results. A clip at the back side of the watch enables easy wall mounting.

| catalogue number | timer dimensions | screen dimensions | pack quantity |
|------------------|------------------|-------------------|---------------|
| 056.02.001 | 69 x 69 x 15 mm | 50 x 26 mm | 1 piece |



TIMER - "electronic"

- Electronic timer counts down with selected intervals of 10 seconds / 1 minute / 5 minute and 10 minute.
- A clear visual and audial signal flashes at the end of the selected time.
- LCD screen with 30 x 80 mm dimensions provides easy reading option from relatively long distances.
- The folding stand at the back housing offers a convenient angle for easy reading.
- A clip at the back side of the watch enables easy wall mounting. Can be hanged on metal surfaces with the two magnets provided at the back.

| catalogue number | timer dimensions | screen dimensions | pack quantity |
|------------------|------------------|-------------------|---------------|
| 056.04.001 | 70 x 90 mm | 30 x 80 mm | 1 piece |

density & sedimentation & temperature & time & pH & weight measurement

METER - "portable" - "pH & mV & temperature measurement"



- Offers an economical solution for measuring pH & mV and temperature. Simple to calibrate by one keyboard.
- Easy to replace electrode. The new electrode will be recognised automatically and shown at the display.
- Ergonomic, lightweight and waterproof (which can even float on water) housing enables perfect outdoor practice.
- Measured values are shown by a microprocessor based large LCD display.
- Stores maximum and minimum measured values in memory.
- Offers a switchable temperature selection of °C or °F.
- Featured with a low battery and energy consumption indicator.
- Automatic switch-off function closes the circuit after 10 minutes of non use.
- Supplied in a carrying case, with instruction manual and calibration standard set.

Meters are supplied in a sturdy carry case complete with hand held stripe, pH buffer solutions, cleaning solution, instruction manual and other standard accessories.



| catalogue no: 616.01.001 | pH | mV | Temp |
|--------------------------|------------------|---------------|----------------|
| range | -2.00 / 16.00 pH | -1000 / 1000 | 0 / 90°C |
| accuracy | ± 0.01+1 digit | ± 2 + 1 digit | ±0.2 + 1 digit |
| resolution | 0.01 pH | 1 mv | 0.1°C |
| compensation | 0 / 90°C | | |

METER - "portable" - "pH & mV & temperature & conductivity & TDS & salt measurement"

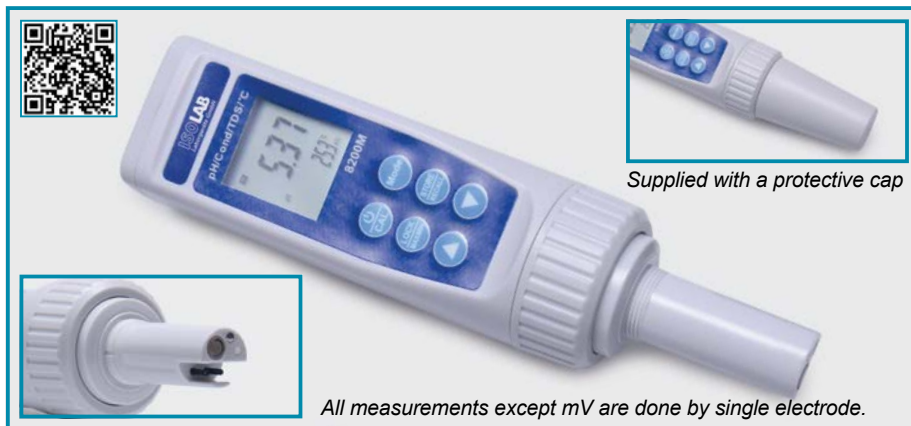

- Offers an economical solution for measuring pH & mV & temperature. & conductivity & TDS & salt with one single electrode.
- Ergonomic, lightweight and waterproof (which can even float on water) housing enables perfect outdoor practice.
- Simple to calibrate by one keyboard. Memory function stores and recalls different measurements.
- Microprocessor based large LCD displays show the measured values and the temperature simultaneously. For mV measurement 616.02.102 should be used.

- Featured with automatic temperature compensation (ATC) . Offers a switchable temperature selection of °C or °F.
- Easy to replace electrode. The new electrode will be recognised automatically and shown at the display.
- Featured with a low battery and energy consumption indicator.
- Automatic switch-off function closes the circuit after 10 minutes of non use.
- Supplied in a carrying case, with instruction manual and calibration standard set.



Meters are supplied in a sturdy carry case complete with hand held stripe, pH buffer solutions, cleaning solution, instruction manual and other standard accessories.

| catalogue no: 616.02.002 | pH | mV | Temp | Conductivity | TDS | Salt |
|--------------------------|------------------|---------------|----------------|----------------------------------|-----------------------------------|--------------------------------|
| range | -2.00 / 16.00 pH | -1999 / 2000 | 0 / 110°C | 0 / 199.9 µs 2.00 / 100.00 ms | 0 / 131.9 ppm 1.30 / 13.19 ppt | 0 / 99.9 ppm 10 / 50.00 ppt |
| accuracy | ± 0.01+1 digit | ± 2 + 1 digit | ±0,2 + 1 digit | ± 2 % FS | | |
| resolution | 0.01 pH | 0,1 / 1 mv | 0.1°C | 0.1 µS / 0.01 mS | 1 ppm / 0.01 ppt | |
| compensation | 0 / 100°C | | | 0 / 50°C | | |

METERS - "table top"

- Featured with microprocessor based design and rugged housing with splash proof keyboard.
- Microprocessor based large LCD display enables fast and accurate measurements.
- Automatic calibration enables fast measuring cycles.
- Easy replacement of electrode and the type of the electrode would be recognised automatically and shown on the display during insertion.
- Can measure and display (depending on model) pH & mV & temperature & conductivity & TDS & salt & dissolved oxygen in seconds.
- The large backlight LCD displays pH or mV or conductivity or TDS or salt or dissolved oxygen and temperature simultaneously.
- Offers a switchable temperature selection of °C or °F.
- Featured with an automatic temperature compensation (ATC).
- Stores maximum and minimum measured values in memory. Memory function can keep and recall up to 150 data.
- ORP probe is optional. **Cat. No. 616.11.109.**



Table top meters have a special platform with a magnetic stirrer which enables fast and accurate measurements and results.

Membrane keypad with large backlight LCD displays pH or mV or conductivity or TDS or salt or dissolved oxygen and temperature simultaneously.

| catalogue no: 616.11.001 | | | |
|--------------------------|-----------------|--|--------------|
| | pH | ORP | Temp |
| range | -2.00/ 16.00 pH | -1999/ -200 mV -199.9/ 499.9 mV 500/ 2000 mV | 0/ 110°C |
| accuracy | ± 0.01+1 digit | ± 2 + 1 digit | ±0.2+1 digit |
| resolution | 0.01 pH | 0.1/ 1 mv | 0.1°C |
| compensation | ATC: 0/ 100°C | N/A | |

| catalogue no: 616.12.001 | | | | | | | | |
|--------------------------|-----------------|--|------------|---|--|---|--|------------|
| | pH | mV | Temp | Conductivity | TDS | Salt | DO | O2 |
| range | -2.00/ 16.00 pH | -1999/ -200 mV -199.9/ 499.9 mV 500/ 2000 mV | 0/ 110°C | 0.0/ 199.9 µS 200/ 1999 µS 2.00/ 19.99 mS 20.0/ 100.0 mS | 0.0/ 131.9 ppm 132/ 1319 ppm 1.32/ 13.19 ppt 13.2/ 66.0 ppt | 0.0/ 99.9 ppm 100/ 999 ppm 1.00/ 9.99 ppt 10.0/ 50.0 ppt | 0/ 20.00 mg/L 0/ 20.00 ppm | 0/ 200.0 % |
| accuracy | ± 0.01+1 digit | ± 2 + 1 digit | ±1+1 digit | ± 2 % FS | | | ± 0.2 + 1 digit | ± 2 % FS |
| resolution | 0.01 pH | 0.1/ 1 mv | 0.1°C | 0.1µS/ 0.1mS | 0.1 ppm/ 0.1 ppt | 0.1 ppm/ 0.1 ppt | 0.01 mg/ L | 0.10% |
| compensation | ATC: 0/ 100°C | N/A | | ATC: 0/ 60°C | | | ATC: 0/ 60°C MSC: 0/ 50 ppt MAC: 0/ 20000 ft | |

ACCESORIES - "for pH meters"



pH BUFFER SOLUTIONS

➤ Ready to use pH buffer solutions with color coding, accuracy +/- 0,01 pH at 20°C. Traceable to NIST, packed in unique designed, practical twin-neck dosing bottles!

➤ Unique and innovative design of the "twin neck" dosing bottles offers multiple advantages:

➤ No need for a separate measuring container during calibration.

➤ No waste of buffer since exact and correct quantity of buffer is dispensed into the calibrating chamber at all times.

➤ Ideally suited for field work and easy to carry.

Operation is simple, fast and easy;

➤ Open safety lock of the integrated calibration chamber.

➤ Fill calibration chamber from buffer reservoir by pressing the bottle gently.

➤ Calibrate pH electrode then discard used buffer solution. Bottle is now ready for the following use.

| catalogue number | pH range | color | volume | pack quantity |
|------------------|----------|--------|---------|---------------|
| 502.04.500 | 4.00 | red | 500 ml | 1 piece |
| 502.04.901 | 4.00 | red | 1000 ml | 1 piece |
| 502.07.500 | 7.00 | yellow | 500 ml | 1 piece |
| 502.07.901 | 7.00 | yellow | 1000 ml | 1 piece |
| 502.10.500 | 10.00 | blue | 500 ml | 1 piece |
| 502.10.901 | 10.00 | blue | 1000 ml | 1 piece |



pH BUFFER SOLUTIONS

➤ Ready to use pH buffer solutions at 20°C.

➤ Measured with a combination glass electrode after multiple point calibration with reference materials.

➤ It is certified traceable to the following National Institute of Standards and Technology (USA).



| catalogue number | pH range | technical specifications | volume (ml) | box quantity |
|------------------|--------------|--|-------------|--------------|
| 908.B01.1000 | 1.00 ± 0.02 | (hydrochloric acid, potassium chloride) | 1000 | 1 piece |
| 908.B02.1000 | 2.00 ± 0.02 | (glycine, hydrochloric acid, sodium chloride) | 1000 | 1 piece |
| 908.B03.1000 | 3.00 ± 0.02 | (potassium hydrogen phthalate, hydrochloric acid) | 1000 | 1 piece |
| 908.B04.1000 | 4.00 ± 0.01 | (potassium hydrogen phthalate) | 1000 | 1 piece |
| 908.B05.1000 | 5.00 ± 0.01 | (potassium hydrogen phthalate, 1m sodium hydroxide.) | 1000 | 1 piece |
| 908.B06.1000 | 6.00 ± 0.01 | (potassium di-hydrogen orthophosphate, disodium hydrogen orthophosphate) | 1000 | 1 piece |
| 908.B07.1000 | 7.00 ± 0.01 | (potassium di-hydrogen phosphate, disodium hydrogen phosphate) | 1000 | 1 piece |
| 908.B08.1000 | 8.00 ± 0.01 | (di-sodium tetraborate, 1m hydrochloric acid) | 1000 | 1 piece |
| 908.B09.1000 | 9.00 ± 0.01 | (di-sodium tetraborate, 1m hydrochloric acid.) | 1000 | 1 piece |
| 908.B10.1000 | 10.00 ± 0.01 | (di-sodium tetraborate, 1m sodium hydroxide) | 1000 | 1 piece |
| 908.B11.1000 | 11.00 ± 0.05 | (glycine, sodium chloride, sodium hydroxide) | 1000 | 1 piece |



LITHMUS PAPERS - "red & blue"

- Litmus papers are the simplest and easiest way to measure pH values where no precise pH value is required. They are useful for determining whether a solution is acidic or basic.
- The red litmus paper has a pH measurement range 5,0 pH to 8,0 pH. The color changes from **red** → **blue**
- The blue litmus paper has a pH measurement range 8,0 pH to 5,0 pH. The color changes from **blue** → **red**
- Packed as a booklet of 20 papers. 10 booklets are packed in a polystyrene box for for easy dispensing.

| catalogue number | paper type | pack quantity |
|------------------|------------|---------------|
| 101.01.001 | red | 10 booklets |
| 101.01.002 | blue | 10 booklets |



pH PAPER - "universal" - "roll"

- Most commonly used pH papers for a wide field of application of pH measurement. They can measure pH values between 1,0 pH to 14,0 pH with 1 pH intervals.
- They provide easy pH measurement of solutions by using single color change.
- After the measurement, the pH value can be found by matching the color on the paper with the reference color chart printed at the back side of the box.
- Supplied in a box roll of 6 mm width and 5 meters length.

| catalogue number | pack quantity |
|------------------|---------------|
| 101.02.002 | 1 box |



pH INDICATOR STRIPS

- They provide precise pH measurement of solutions by using single color change.
- pH measurement pads with different colors are chemically bounded to a cellulose fiber stick.
- This effectively protects the sample against contamination and enables measurements even in weakly buffered or strongly alkaline solutions.
- Fingers are protected from the test solution since the test pads are located at the extreme end of the strips.
- Since the pads do not bleed, pad colors do not interfere and mix with each other after the test and ensures reliable pH measurement.
- After the measurement, the pH value can be found by matching the colors on the pads with the reference color chart printed at the back side of the box.
- 100 pieces strip is packed in a clear polystyrene box for hygienic storage and for easy dispensing.

| Isolab brand | M. Nagel brand | pH measuring range | pH graduation | strip width | strip length | pack quantity | box quantity |
|--------------|----------------|--------------------|---------------|-------------|--------------|---------------|--------------|
| 101.02.001 | 101.02.003 | 0,0 - 14,0 pH | 1,0 pH | 6 mm | 80 mm | 100 strips | 1000 strips |

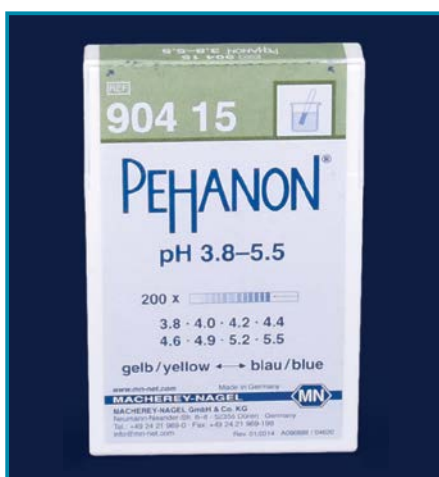

TEST STRIPS - "PEHANON"

- Test strip for pH measurement which unifies the pH-indicator with the reference pH color chart on the same strip.
- pH values can be determined without a separate color chart. They provide precise pH measurement of solutions by using single color change.
- The user can be sure to get accurate pH values at all times.
- Fast measurement results are guaranteed since they do not require an addition step of matching the pad color with a reference color scale.
- The handle will remain dry and clean by the invisible hydrophobic barrier.
- 200 pieces strip is packed in a clear polystyrene box for hygienic storage and for easy dispensing.

| Isolab brand | M. Nagel brand | pH measuring range | pH graduation | strip width | strip length | pack quantity | box quantity |
|--------------|----------------|--------------------|---------------|-------------|--------------|---------------|--------------|
| 101.14.003 | 101.04.003 | 3,8 - 5,5 pH | 0,2/0,3 pH | 6 mm | 80 mm | 200 strips | 2000 strips |

QUANTOFIX TEST STRIPS - "peroxide"

- A very special "ready-to-use" test strip with semi-quantitative nature for various measurements.
- Can be considered as ready to use kits that give precise results 10 - 120 seconds after use. Precise graduations guarantees reliable test results.
- The color chart is adjusted by certified standard solutions which are directly traceable to NIST standards.
- For reliable test results and longevity of the strip closing the cap after removing the strip is recommended.
- The desiccant in the stopper also effectively protects the strip against moisture.
- 100 pieces strip are packed in a box for hygienic storage and for easy dispensing.

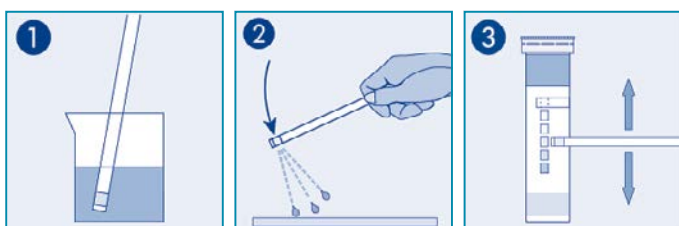

Dip the test strip in sample as far as the arrow indicates. Shake off excess liquid and place the strip on a horizontal surface. Read the result by comparing the test field with the color scale for one second.



| Isolab brand | M. Nagel brand | product name | product type | graduation | strip width | strip length | pack quantity | box quantity |
|--------------|----------------|--------------|--------------|--|-------------|--------------|---------------|--------------|
| 101.13.003 | 101.03.003 | QUANTOFIX | PEROXIDO 100 | 0 - 1 - 3 - 10 - 30 - 100 mg/L H ₂ O ₂ | 6 mm | 95 mm | 100 strips | 1000 strips |

TEST STRIPS - "for water hardness"

- In dialysis hard water can damage the delicate osmosis units.
- For this reason accurate and quick testing of water hardness is very important
- "Diaquant" test strips are specially designed for reliable and accurate low-range water hardness tests of rinse and feed water specially at dialysis environment.
- All water hardness tests are done simple and fast without any mixing.
- The easy dip & read procedure provides a reliable result in 10 seconds.
- After the test color changes from white to pink.
- Packed in a box of 50 strips of 6 mm width and 95 mm length.

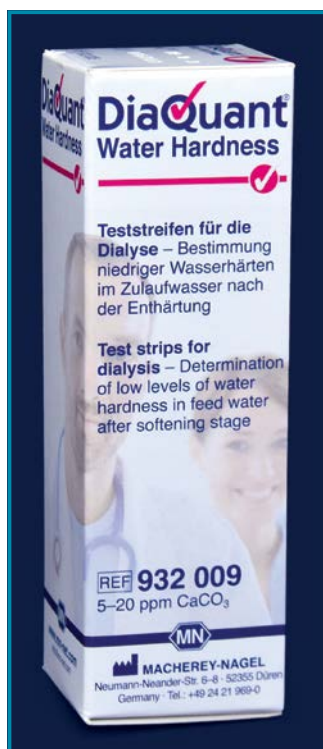

| Isolab brand | M. Nagel brand | graduation | pack quantity |
|--------------|----------------|---------------------------------------|---------------|
| 101.13.005 | 101.03.005 | 0 - 5 - 10 - 20 ppm CaCO ₃ | 50 pieces |

AQUADUR TEST STRIPS

- A special "ready-to-use" test strip for determination of water hardness.
- Clear color changes from green to red guarantees reliable test results.
- Can precisely determine water hardness in a liquid very precisely from very soft water to very hard water.
- Since the color change is very clear and sharp with green / red indication they do not require any reference color scale for matching.
- The hardness of the water depends on its content of calcium and magnesium salts and expressed in terms of ppm (mg/l) CaCO₃.
- Packed in a box of 100 strips of 6 mm width and 95 mm length.



| Isolab brand | M. Nagel brand | graduation | pack quantity |
|--------------|----------------|-------------------------|---------------|
| 101.13.004 | 101.03.004 | <3->5->10->15->20->25°d | 100 strips |



BALANCE
"0,0001 g precision"

- Reliable weighing with 0,0001 g precision with single cell weighing system.
- Microprocessor controlled weighing technology guarantees fast and precise results at any time.
- Equipped with internal fully automatic calibration for quick setting of the balance.
- Featured with easy-to-read, large, backlite LCD display with advanced eye protection.
- State-of-art touch button screen with optimised keypad response immediately.
- Robust housing protects internal components from environmental effects.
- Equipped with internal re-chargeable battery. Supplied with a dust cover.

| catalogue no | 602.31.001 |
|----------------------|--------------------------------|
| weighing range (g) | 220 |
| readability (g) | 0,0001 |
| reproducibility (mg) | ± 0,1 |
| linearity (mg) | ± 0,2 |
| pan diameter (mm) | 90 |
| weighing units | mg, g, kg, lb, oz, ozt, gn, ct |
| calibration | internal, fully automatic |
| display | LCD |
| cabin type | full |
| dimensions (mm) | 342 x 212 x 341 |



BALANCE
"0,001 g precision"

- Reliable weighing with 0,001 g precision with single cell weighing system.
- Microprocessor controlled weighing technology guarantees fast and precise results at any time.
- Equipped with external weight calibration system for quick setting.
- Featured with easy-to-read, large, backlite LCD display with advanced eye protection.
- State-of-art touch button screen with optimised keypad response immediately.
- Robust housing protects internal components from environmental effects.
- Equipped with internal re-chargeable battery. Supplied with a dust cover.

| catalogue no | 602.31.002 |
|----------------------|----------------------------|
| weighing range (g) | 320 |
| readability (g) | 0,001 |
| reproducibility (mg) | ± 2 |
| linearity (mg) | ± 3 |
| pan diameter (mm) | 85 |
| weighing units | g, kg, lb, oz, ozt, gn, ct |
| calibration | external |
| display | LCD |
| cabin type | with windshield |
| dimensions (mm) | 280x210x275 |



BALANCE
"0,01 g precision"

- Reliable weighing with 0,01 g precision with single cell weighing system.
- Microprocessor controlled weighing technology guarantees precise results.
- Equipped with external weight calibration system for quick setting.
- Featured with easy-to-read, large, backlite LCD display with advanced eye protection.
- State-of-art touch button screen with optimised keypad response immediately.
- Robust housing protects internal components from environmental effects.
- Equipped with internal rechargeable battery. Supplied with a dust cover.

| catalogue no | 602.31.003 |
|----------------------|----------------------------|
| weighing range (g) | 1200 |
| readability (g) | 0,01 |
| reproducibility (mg) | ± 20 |
| linearity (mg) | ± 20 |
| pan diameter (mm) | 130 |
| weighing units | g, kg, lb, oz, ozt, gn, ct |
| calibration | external |
| display | LCD |
| cabin type | with windshield |
| dimensions (mm) | 280x210x180 |



BALANCE
"0,01 g precision"

- Reliable weighing with 0,01 g precision with single cell weighing system.
- Microprocessor controlled weighing technology guarantees precise results.
- Equipped with external weight calibration system for quick setting.
- Featured with easy-to-read, large, backlite LCD display with advanced eye protection.
- State-of-art touch button screen with optimised keypad response immediately.
- Robust housing protects internal components from environmental effects.
- Equipped with internal rechargeable battery. Supplied with a dust cover.



BALANCE
"0,01 g precision"

- Reliable weighing with 0,1 g precision with single cell weighing system.
- Microprocessor controlled weighing technology guarantees precise results.
- Equipped with external weight calibration system for quick setting.
- Featured with easy-to-read, large, backlite LCD display with advanced eye protection.
- State-of-art touch button screen with optimised keypad response immediately.
- Robust housing protects internal components from environmental effects.
- Equipped with internal rechargeable battery. Supplied with a dust cover.



BALANCE
"0,01 g precision"

- Provides comfortable and reliable weighing with 0,01 g precision.
- Fits even into a pocket. Occupies minimal space on the laboratory bench, yet maintains optimal performance. Ideal assistant where mobility and precision are required.
- Microprocessor controlled weighing technology guarantees precise results.
- Featured with easy-to-read, large, backlite LCD display with advanced eye protection.
- Robust housing protects internal components from environmental effects.
- Battery operated. With auto power off after 30 seconds for energy saving.



| catalogue no | 602.31.006 |
|----------------------|----------------------------|
| weighing range (g) | 4200 |
| readability (g) | 0,01 |
| reproducibility (mg) | ± 20 |
| linearity (mg) | ± 40 |
| pan size (mm) | 185 x 160 |
| weighing units | g, kg, lb, oz, ozt, gn, ct |
| calibration | external |
| display | LCD |
| cabin type | without windshield |
| dimensions (mm) | 280x210x100 mm |

| catalogue no | 602.31.007 |
|----------------------|----------------------------|
| weighing range (g) | 6200 |
| readability (g) | 0,1 |
| reproducibility (mg) | ± 100 |
| linearity (mg) | ± 200 |
| pan size (mm) | 185 x 160 |
| weighing units | g, kg, lb, oz, ozt, gn, ct |
| calibration | external |
| display | LCD |
| cabin type | without windshield |
| dimensions (mm) | 280x210x100 mm |

| catalogue no | 602.32.001 |
|----------------------|--------------------|
| weighing range (g) | 500 |
| readability (g) | 0,01 |
| reproducibility (mg) | ± 50 |
| linearity (mg) | ± 50 |
| pan size (mm) | 100 x 100 |
| weighing units | g, oz, gn, |
| calibration | ----- |
| display | LCD |
| cabin type | without windshield |
| dimensions (mm) | 125x105x16 mm |

density & sedimentation & temperature & time & pH & weight measurement

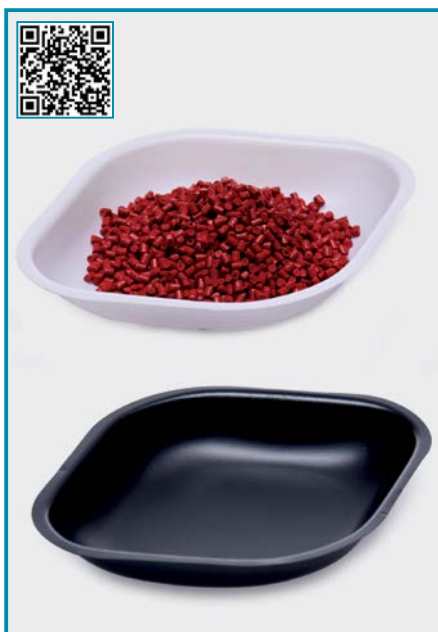

WEIGHING DISHES - "P.S"

- Manufactured from polystyrene for many applications such as weighing, dispensing and storing.
- Anti-static property of the raw material eliminates the static built-up. Specially recommended for weighing fine powders.
- They can also be used as freeze and mixing trays for small batches and also during microwave moisture analysis.
- Guarantees chemical and temperature resistance between -10°C to +70°C.
- Flat bottom ensures perfect stability on counters while smooth and non-porous inner surface provides accurate pour outs with minimal sample loss.

Non-sterile dishes are packed as 100 pieces.
Sterile dishes are packed as 10 pieces.



| dish color | diamond dishes non-sterile | diamond dishes gamma sterile | dish volume | square dishes non-sterile | square dishes gamma sterile | dish volume |
|------------|----------------------------|------------------------------|-------------|---------------------------|-----------------------------|-------------|
| white | 037.05.005 | 037.15.005 | 5 ml | 037.09.007 | 037.19.007 | 7 ml |
| white | 037.05.030 | 037.15.030 | 30 ml | 037.09.100 | 037.19.100 | 100 ml |
| white | 037.05.100 | 037.15.100 | 100 ml | 037.09.250 | 037.19.250 | 250 ml |
| black | 037.06.005 | 037.16.005 | 5 ml | 037.11.007 | 037.21.007 | 7 ml |
| black | 037.06.030 | 037.16.030 | 30 ml | 037.11.100 | 037.21.100 | 100 ml |
| black | 037.06.100 | 037.16.100 | 100 ml | 037.11.250 | 037.21.250 | 250 ml |



With a slight pressure to the sides weighing dishes can easily be covered into a pouring funnel for easy and non-spill transfer of samples.

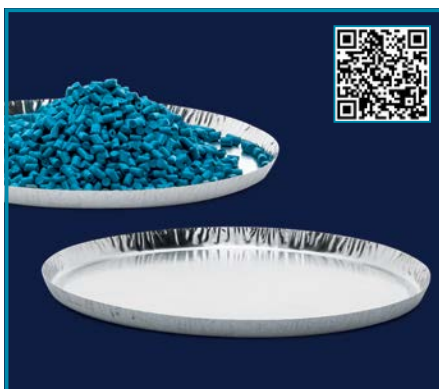

WEIGHING DISHES "aluminum"

- Manufactured from high grade, oil free, durable and light gauge aluminium.
- Unique design guarantees excellent use with moisture determination balances.
- Can also be used as a mixing or weighing pan.
- Wall with 6 mm height guarantees spill-free application.
- Easily stackable due to the tapered body form for reducing storage space.

| catalogue number | Ø x H (mm) | pack quantity |
|------------------|------------|---------------|
| 037.25.100 | 100x6 | 50 pieces |



WEIGHING DISHES "aluminum"

- Manufactured from high grade, oil free, durable and light gauge aluminium. Featured with compressed walls for extra stability.
- Designed to be used as weighing dishes, evaporating dishes or drying dishes.
- Featured with a handle which enables easy holding of the dish. Can also be used as a marking surface.
- Easily stackable due to the tapered body form for reducing storage space.

| catalogue number | Ø x H (mm) | pack quantity |
|------------------|------------|---------------|
| 037.24.045 | 49x12 | 100 pieces |
| 037.24.055 | 60x15 | 100 pieces |
| 037.24.065 | 66x16 | 100 pieces |



WEIGHING DISHES "aluminum"

- Manufactured from high grade, oil free, durable and light gauge aluminium. Featured with compressed walls for extra stability.
- Unique design offers variety of applications. They can be used as weighing dishes, as mixing dishes also even as dishes for storing samples.
- Easily stackable due to the tapered body form for reducing storage space.

| catalogue number | Ø x H (mm) | pack quantity |
|------------------|------------|---------------|
| 037.23.070 | 70x22 | 100 pieces |
| 037.23.085 | 88x38 | 100 pieces |
| 037.23.110 | 110x34 | 100 pieces |

density & sedimentation & temperature & time & pH & weight measurement



WEIGHING SCOOPS - "glass"

➤ Made from glass with flat base ensuring stability on the balance pans.

➤ Hollow stem enables very easy powder transfer.

| catalogue number | max. volume | pack quantity |
|------------------|-------------|---------------|
| 037.07.001 | 3 ml | 1 piece |
| 037.07.002 | 6 ml | 1 piece |
| 037.07.003 | 10 ml | 1 piece |



WEIGHING SCOOPS - "stainless steel"

➤ Manufactured from stainless steel.

➤ Highly polished smooth interior provides accurate pours without sample loss.

| catalogue number | length | pack quantity |
|------------------|--------|---------------|
| 037.04.001 | 95 mm | 1 piece |
| 037.04.002 | 117 mm | 1 piece |
| 037.04.003 | 125 mm | 1 piece |



WATCH GLASSES - "glass"

➤ Manufactured from soda-lime glass according to DIN 12341 standard. Ideal tools also for evaporation applications and for covering the hot beakers.

➤ Fire polished edges prevent chipping and avoid breakage.

| catalogue number | Ø (mm) | pack quantity |
|------------------|--------|---------------|
| 037.01.050 | 50 | 10 pieces |
| 037.01.060 | 60 | 10 pieces |
| 037.01.070 | 70 | 10 pieces |
| 037.01.080 | 80 | 10 pieces |
| 037.01.100 | 100 | 10 pieces |
| 037.01.125 | 125 | 10 pieces |
| 037.01.150 | 150 | 10 pieces |
| 037.01.200 | 200 | 10 pieces |



WEIGHING BOTTLES - "glass"

➤ Manufactured from heat resistant, durable borosilicate glass complete with a lid.

➤ The interchangeable lids perfectly fit to the NS necks. Once closed they provide hermetical closure.

| catalogue number | Ø x H (mm) | pack quantity |
|------------------|------------|---------------|
| 037.02.254 | 25 x 40 | 1 piece |
| 037.02.353 | 35 x 30 | 1 piece |
| 037.02.402 | 40 x 25 | 1 piece |
| 037.02.305 | 30 x 50 | 1 piece |
| 037.02.503 | 50 x 30 | 1 piece |
| 037.02.357 | 35 x 70 | 1 piece |
| 037.02.603 | 60 x 30 | 1 piece |
| 037.02.408 | 40 x 80 | 1 piece |
| 037.02.803 | 80 x 30 | 1 piece |
| 037.02.508 | 50 x 80 | 1 piece |



WEIGHING PAPER

➤ Manufactured from impervious and transparent paper specially suitable for weighing.

➤ Leaves no residue and impurity during and after weighing application.

➤ Cut as 100 x 100 mm dimensions and packed as a booklet of 250 papers.

| catalogue number | pack quantity |
|------------------|---------------|
| 037.33.001 | 1 booklet |



WEIGHING BRUSH

➤ Ideal tool for cleaning weighing boats, balance pans, weighing dishes and any similar object.

➤ Manufactured from extremely soft synthetic hair.

➤ Pointed tip provides excellent effective cleaning.

| catalogue number | pack quantity |
|------------------|---------------|
| 037.32.001 | 1 piece |



DENSITY BOTTLES - "non - calibrated & calibrated"

- All density bottles are manufactured according to ISO 3507 standard. For easy differentiation both the body and the stopper carries the same identification code number.
- They are supplied with a stopper with excellently polished upper and lower ends. Nominal volume and inscriptions are printed with blue enamel.
- **Non-calibrated density bottles** are supplied without calibration.
- **Calibrated density bottles** are calibrated together with the stopper with a precision of 0,001 ml. Net volume is engraved on the body.
- **Calibrated density bottles** with thermometer are calibrated together with the stopper with a precision of 0,001 ml. Net volume is engraved on the body. Supplied with a thermometer of scale range +10°C to +40°C, with scale 0,5°C.

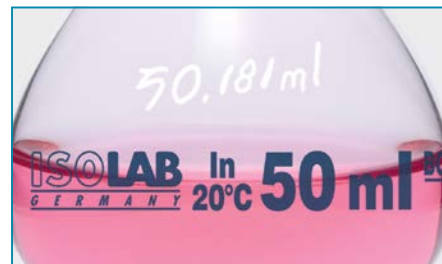

Net volume with 0,001 ml precision is engraved on the body of calibrated density bottles.

| volume | non-calibrated density bottles | calibrated density bottles | calibrated density bottles with thermometer | pack quantity |
|--------|--------------------------------|----------------------------|---|---------------|
| 5 ml | 023.01.005 | 023.02.005 | 023.03.005 | 1 piece |
| 10 ml | 023.01.010 | 023.02.010 | 023.03.010 | 1 piece |
| 25 ml | 023.01.025 | 023.02.025 | 023.03.025 | 1 piece |
| 50 ml | 023.01.050 | 023.02.050 | 023.03.050 | 1 piece |
| 100 ml | 023.01.100 | 023.02.100 | 023.03.100 | 1 piece |

IMHOFF CONES

➤ Manufactured from heat resistant, durable borosilicate glass according for sedimentation tests according to DIN 12672 standard.

➤ Featured with volume graduation of 1000 ml. Volume graduations and inscriptions are printed with white enamel.

| graduation range | subdivision |
|------------------|-------------|
| 0 - 2 ml | 0,1 ml |
| > 2 - 10 ml | 0,5 ml |
| > 10 - 40 ml | 1,0 ml |
| > 40 - 100 ml | 2,0 ml |
| > 100 - 1000 ml | 50,0 ml |

| catalogue number | cone type | pack quantity |
|------------------|------------------|---------------|
| 043.20.001 | without stopcock | 1 piece |
| 043.20.002 | with stopcock | 1 piece |



IMHOFF CONE STANDS

➤ Manufactured to hold two imhoff sedimentation cones of any type.

➤ Compact design allows easy carry of imhoff cones even when the cones are filled.

| catalogue number | rack type | pack quantity |
|------------------|-----------|---------------|
| 043.22.002 | PMMA | 1 piece |

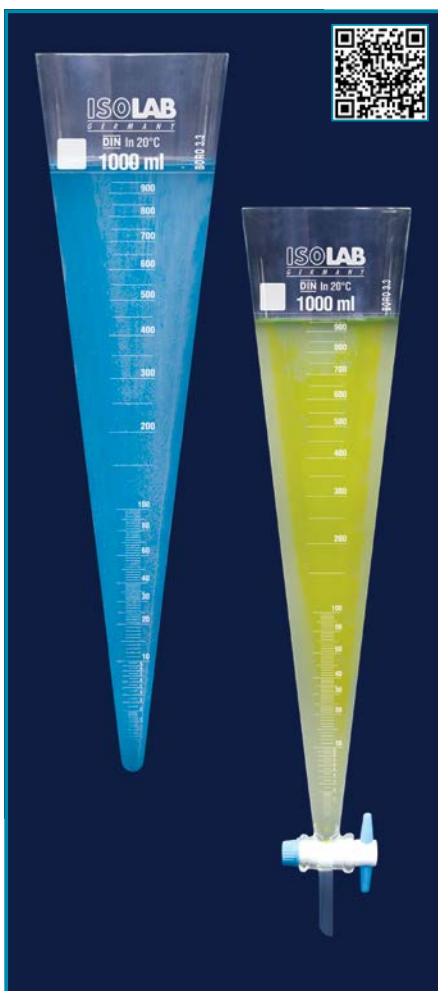



*stirring & mixing
shaking & heating
cooling*

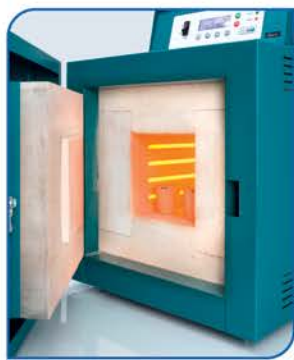

stirring & mixing & shaking & heating & cooling



MAGNETIC STIRRER - "with hot plate"

| | |
|--------------|-------------------|
| catalogue no | 613.06.001 |
| dimensions | 215x360x112 mm |
| weight | 5,3 kg |
| plate size | 184 x 184 mm |
| top plate | glass ceramic |
| motor type | DC motor |
| power | 1050 W |
| voltage | 100 - 240 V |
| frequency | 50 / 60 Hz |
| capacity | 20 L |
| range | 100 - 1500 rpm |
| display | LCD |
| output | 1000 W |
| range | room temp - 550°C |
| accuracy | ±1 % > 100°C |
| safety temp. | 580°C |
| warning | 50°C |
| accessories | sensor PT 1000 |

- Featured with an explosion proof brushless DC motor with low noise level offers a stirring volume up to 20 lt.
- Ceramic top plate guarantees perfect chemical resistance against acids.
- Integrated the heater provides excellent heat transfer rate and quick heat up.
- Aluminium alloy housing protects all components from aggressive effects and guarantees safety with a long life time.
- Electronic speed control from 100 to 1500 rpm provides a precise stirring.
- LCD panel for display for set & actual temperature and set & actual speed.
- Guarantees excellent heating control from ambient temperature to 550°C.
- Overheat protection circuit turns off the heater if the top plate temperature reaches 580°C for any reason. LCD display will show "HOT" if hotplate temperature is over 50°C.
- Supplied complete with PT1000 temperature sensor, support rod and fixing clamp.



MAGNETIC STIRRER - "with hot plate"

| | |
|--------------|-------------------|
| catalogue no | 613.01.001 |
| dimensions | 268x160x86 mm |
| weight | 1,8 kg |
| plate size | Ø135 |
| top plate | stainless steel |
| motor type | DC motor |
| power | 630 W |
| voltage | 100 - 240 V |
| frequency | 50 / 60 Hz |
| capacity | 3 L |
| range | 100 - 1500 rpm |
| display | LED |
| output | 600 W |
| range | room temp - 280°C |
| accuracy | ±0.1°C |
| safety temp. | 50 - 320°C |
| warning | 50°C |
| accessories | sensor PT 1000 |

- Featured with an brushless DC motor with low noise level offers a stirring volume up to 3 lt.
- Ceramic top plate guarantees perfect chemical resistance against acids.
- Integrated the heater provides excellent heat transfer rate and quick heat up.
- ABS housing protects all components from aggressive effects and guarantees safety with a long life time.
- Electronic speed control from 100 to 1500 rpm provides a precise stirring.
- LED panel for display for set & actual temperature and set & actual speed.
- Guarantees excellent heating control from ambient temperature to 280°C.
- Overheat protection circuit turns off the heater if the top plate temperature reaches 320°C for any reason.
- Supplied complete with PT1000 temperature sensor.
- Please kindly order support rod separately **Cat. No 613.01.102**

stirring & mixing & shaking & heating & cooling



MAGNETIC STIRRER - "without hot plate"

| | |
|--------------|----------------|
| catalogue no | 613.03.001 |
| dimensions | 150x260x80 mm |
| weight | 1,8 kg |
| plate size | Ø135 |
| motor type | DC motor |
| power | 15 W |
| voltage | 220 V |
| frequency | 50 / 60 Hz |
| capacity | 3 L |
| range | 100 - 1500 rpm |
| display | LED |

➤ Maintenance free DC motor with low noise level offers a stirring volume up to 3 lt with a smooth start and quick stop.

➤ Electronic speed control from 100 to 1500 rpm provides a gentle revolution and precise stirring speed even at maximum speed range.

➤ Large LED panel offers simultaneous display for set & actual speed.

➤ ABS housing protects all mechanical and electronic components from aggressive effects and guarantees safety with a long life time.

➤ Also provides impact resistant, easily cleanable, scratch-proof surface.



MAGNETIC STIRRER - "without hot plate"

| | |
|--------------|----------------|
| catalogue no | 613.05.001 |
| dimensions | 150x145x50 mm |
| weight | 0,3 kg |
| plate size | Ø120 |
| motor type | DC motor |
| power | 7,2 W |
| voltage | 220 V |
| frequency | 50 / 60 Hz |
| capacity | 1,5 L |
| range | 300 - 2000 rpm |
| display | N/A |

➤ This light weight, compact designed magnetic stirrer is specially recommended for titration applications.

➤ Electronic speed control from 300 to 2.000 rpm provides precise stirring speed even at maximum speed range.

➤ DC motor offers a stirring volume up to 1,5 lt with a smooth start and quick stop.

➤ PET housing protects components from aggressive effects.

➤ Anti-slip silicone feet pads minimize vibration and guarantee excellent stability.

➤ Featured with an adjustable clamp holder suitable to hold electrodes and other probes.



MAGNETIC STIRRER - "without hot plate"

| | |
|--------------|----------------|
| catalogue no | 613.07.001 |
| dimensions | 115x175x12 mm |
| weight | 0,35 kg |
| plate size | Ø100 |
| motor type | Magnetic motor |
| power | 5 W |
| voltage | 220 V |
| frequency | 50 / 60 Hz |
| capacity | 0,8 L |
| range | 15 - 1500 rpm |
| display | N/A |

➤ This ultra-flat, compact designed magnetic stirrer with only 350 gr weight can be carried even in a pocket.

➤ Specially recommended for titration applications. Offers a stirring volume up to 0,8 lt with a smooth start and quick stop.

➤ Electronic speed control from 15 to 1500 rpm provides precise stirring speed even at maximum speed range.

➤ Featured with automatic reverse rotation function for more efficient mixing.

➤ ABS housing protects all components from aggressive effects.

➤ Also provides impact resistant, easily cleanable, scratch-proof surface.

stirring & mixing & shaking & heating & cooling



MAGNETIC STIRRING BARS
"cylindrical"

- Manufactured from ALNICO (an alloy of aluminium, nickel, iron and cobalt) magnets encapsulated with PTFE coating.
- Cylindrical magnetic stirring bars offer for a wide variety of applications providing excellent mixing effect.
- Polished finish provides excellent centering and smooth uninterrupted stirring.
- Their perfect contacts with the base of the flask reduce the risk of ricochet during stirring.

| catalogue number | length | diameter | pack quantity |
|------------------|--------|----------|---------------|
| 057.01.010 | 10 mm | 6 mm | 10 pieces |
| 057.01.015 | 15 mm | 6 mm | 10 pieces |
| 057.01.020 | 20 mm | 6 mm | 10 pieces |
| 057.01.025 | 25 mm | 6 mm | 10 pieces |
| 057.01.030 | 30 mm | 6 mm | 10 pieces |
| 057.01.035 | 35 mm | 6 mm | 10 pieces |
| 057.01.040 | 40 mm | 8 mm | 10 pieces |
| 057.01.045 | 45 mm | 8 mm | 10 pieces |
| 057.01.050 | 50 mm | 8 mm | 6 pieces |
| 057.01.060 | 60 mm | 9 mm | 6 pieces |
| 057.01.070 | 70 mm | 9 mm | 6 pieces |
| 057.01.080 | 80 mm | 9 mm | 6 pieces |



MAGNETIC STIRRING BARS
"oval - elliptical"

- Manufactured from ALNICO (an alloy of aluminium, nickel, iron and cobalt) magnets encapsulated with PTFE coating.
- These elliptic magnetic stirrer bars provide excellent mixing effect specially when used with round bottom flasks.
- Their egg shapes guarantee unrestricted spinning and effective mixing by perfect adaptation of the vessel contour.

| catalogue number | length | diameter | pack quantity |
|------------------|--------|----------|---------------|
| 057.05.020 | 20 mm | 8 mm | 1 piece |
| 057.05.025 | 25 mm | 10 mm | 1 piece |
| 057.05.030 | 30 mm | 11 mm | 1 piece |
| 057.05.035 | 35 mm | 12 mm | 1 piece |
| 057.05.040 | 40 mm | 15 mm | 1 piece |



MAGNETIC STIRRING BARS
"cross form"

- Manufactured from ALNICO (an alloy of aluminium, nickel, iron and cobalt) magnets encapsulated with PTFE coating.
- Cross formed magnetic stirring bar creates a deep vortex even at relatively slow speeds and provides an excellent mixing.
- Their angled body forms reduce the friction effect during stirring and provide excellent centering and smooth uninterrupted stirring.
- Their perfect contacts with the base of the flask reduce the risk of ricochet during stirring.

| catalogue number | dimensions | pack quantity |
|------------------|------------|---------------|
| 057.06.037 | 37 x 37 mm | 1 piece |

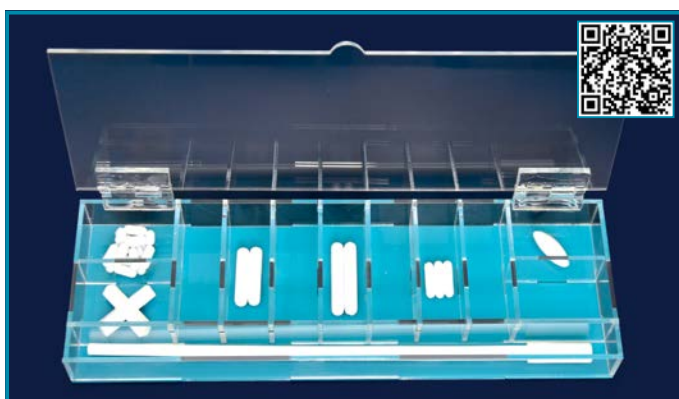

BOX - "with compartments" - "acrylic"

- Manufactured from acrylic featured with different size compartments. Offers practical positioning and easy reach of different size small objects such as magnetic stirrers.
- The long compartment is ideal to store longer objects including magnetic bar retrievers. Featured with a lid protecting the box interior from environmental conditions.

| catalogue number | box width | box length | box height | compartment quantity | pack quantity |
|------------------|-----------|------------|------------|----------------------|---------------|
| 057.02.101 | 330 mm | 110 mm | 35 mm | 12 | 1 piece |



STIRRING ROD - "glass"

- Glass rods are manufactured from rods with different diameters and lengths.
- Their flame polished ends prevents unexpected breakage during applications. They offer practical solutions for mixing and stirring solutions by hand.

| glass stirring rod | length | diameter | pack quantity |
|--------------------|--------|----------|---------------|
| 057.03.200 | 200 mm | 5 mm | 10 pieces |
| 057.03.250 | 250 mm | 6 mm | 10 pieces |
| 057.03.300 | 300 mm | 6 mm | 10 pieces |

MAGNETIC BAR RETRIEVERS

- Constructed with a PTFE encapsulated powerful magnet at the end of a long stem.
- Essential tool for picking up the magnetic stirring bars from flasks after use without losing them.
- They offer risk-free removal of magnetic stirring bars even from aggressive liquids and reduce the risk of magnetic bar loss.
- **Alternative 2 retrievers:**
 - With solid stem
 - With flexible stem
- Magnetic bar retriever with flexible stem guarantees easy reach to the edges of the cornered flasks such as erlenmeyers.

| catalogue number | retriever model | stem length | pack quantity |
|------------------|-----------------|-------------|---------------|
| 057.02.001 | solid stem | 270 mm | 1 piece |
| 057.02.002 | flexible stem | 300 mm | 1 piece |

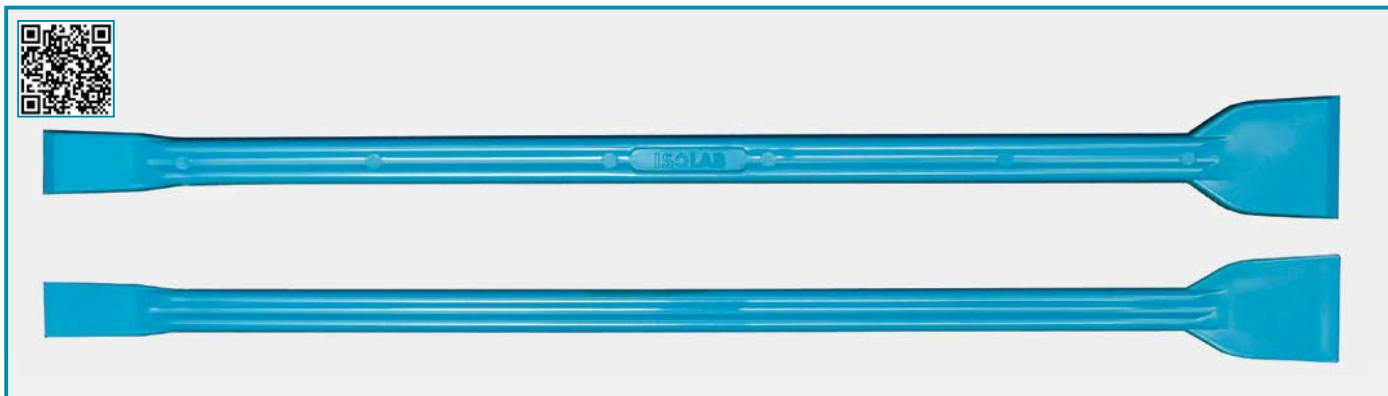
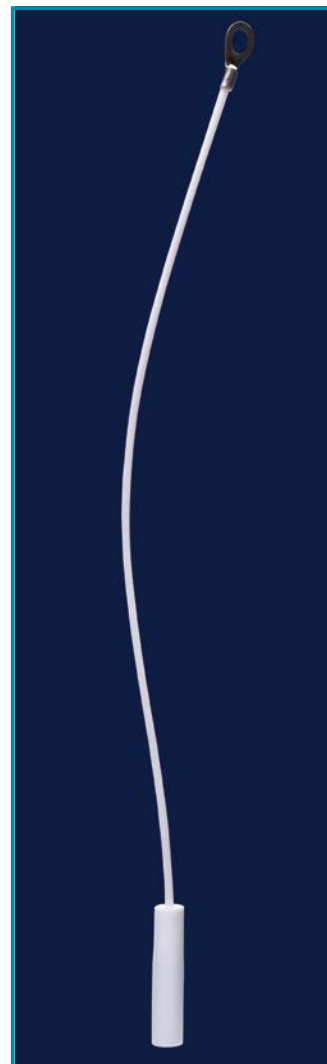

STIRRING ROD - "polypropylene"

- Manufactured from polypropylene with a flattened ends for effective mixing.
- Offers practical solutions for mixing and stirring solutions both for narrow and wide neck flasks.
- Featured with two flat ends with different widths on a single handle.
- Flat ends have 35 degree sharp edges for easy removal of the residues on flat surfaces.

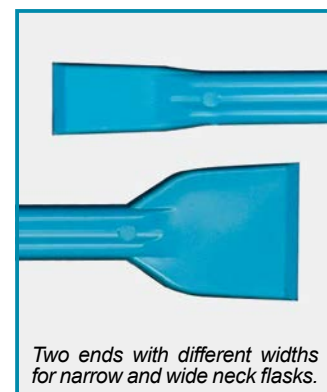
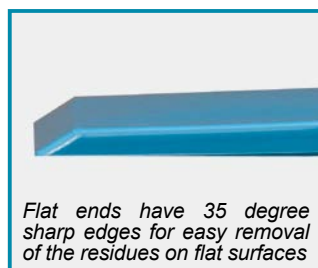

| catalogue number | total length | narrow end width | large end width | pack quantity |
|------------------|--------------|------------------|-----------------|---------------|
| 057.04.251 | 240 mm | 12 mm | 23 mm | 10 pieces |



MECHANICAL STIRRER - "light duty"

| | |
|----------------|---------------|
| catalogue no | 615.01.001 |
| dimensions | 83x220x186 mm |
| weight | 2,6 kg |
| motor type | DC motor |
| power | 70 W |
| voltage | 100 - 240 V |
| frequency | 50 / 60 Hz |
| capacity | 20 L |
| range | 0 - 2200 rpm |
| display | LED |
| resolution | ± 1 rpm |
| max. torque | 40 Ncm |
| max. viscosity | 10000 mPas |
| chuck dia. | 0,5 - 10 mm |

► Highly reliable design for stirring low to medium viscous media with a vibration free and silent operation.

► Maintenance free, silent and explosion proof DC motor offers a stirring volume up to 20 l with a smooth start without sample overflow and a quick stop.

► Sturdy aluminium main body efficiently absorbs and emits the heat generated by the motor.

► Electronic speed control from 0 to 2200 rpm provides a gentle revolution and precise stirring speed even at high temperatures.

► Large LED panel for simultaneous display for set & actual speed.

► Overload safety feature automatically stops the operation and protects all mechanical and electronic components.

► Stirring shafts can be easily inserted to their position by "push through" system.

► Stirring shaft, stand and fixing clamp are not supplied as a standard accessory. These should be ordered separately.

accessories for mechanical stirrer - "stand & bosshead"



Bosshead manufactured from steel with opening distance of 0 - 20 mm.

Sturdy construction specially enables holding heavy objects such as stirrers.
Catalogue No: 615.01.012

Stirrer stand is made from powder coated cast steel.

Unique base design offers very stable holding of the assembled stirrer and also possibility of getting close to the stand rod.

Supplied complete with 14 mm diameter stainless steel support rod.
Catalogue No: 049.09.250

accessories for mechanical stirrer - "stirring shafts"

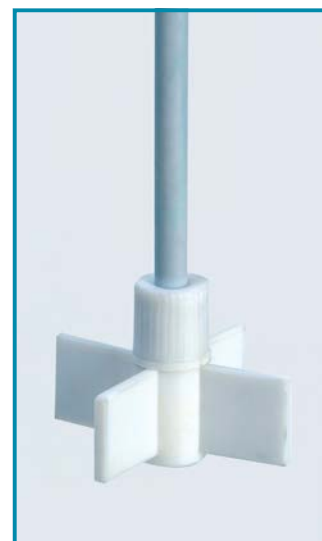

| catalogue number | shaft type | shaft dia. & length | shaft material | recommended for |
|------------------|------------|---------------------|----------------|---------------------|
| 615.01.101 | cross | 9,0 x 400 mm | st. steel | medium & high speed |
| 615.01.103 | cross | 8,5 x 350 mm | PTFE | medium & high speed |

stirring & mixing & shaking & heating & cooling

HOMOGENIZER - "light duty"

| | |
|-----------------------|-----------------------------------|
| catalogue no | 621.11.001 |
| dimensions | 45x55x230 mm |
| weight | 0,6 kg |
| motor type | carbon brush |
| power | 160 W |
| voltage | 220 V |
| frequency | 50 Hz |
| range | 8000 - 30000 rpm |
| control | 6 stage |
| max. viscosity | 5000 mPas |
| working volume | 0,1 - 50 ml with shaft 621.11.050 |
| working volume | 1 - 250 ml with shaft 621.11.250 |

➤ Practical solution if mixing, emulsification, shredding or chopping is required for small samples.

➤ High torque motor with a variable speed adjustment enables rapid and effective disruption of a wide range of samples.

➤ Speed control as 8.000, 12.000, 15.000, 18.000, 22.000, 30.000 rpm.

➤ Different rotors and stators enables adaptation to most applications.

➤ Can homogenize samples in range 0,1 ml to 50 ml or 1 ml - 250 ml of liquid depending on the rotor/stator type.

➤ Maximum speed of 30.000 rpm rate reduces processing time significantly.

➤ Complete homogenization of samples is usually achieved in a few seconds.

➤ Smooth motor drive makes working very safe and comfortable.

➤ Smooth acceleration also prevents unnecessary spills. An overload protection feature increases the life span of the motor.

"shafts" & "rotors" and "stators"

➤ Shafts, rotors, stators are not supplied as a standard accessory. These should be ordered separately.

➤ Assembly and disassembly of rotors can be done without requirement of special tools.

➤ Shafts, rotors and stators are constructed of quality AISI 316 stainless steel which is inert to aggressive solutions



Light duty homogenizer is supplied without bosshead, clamp, stand and rotor/stator set.

Bosshead manufactured from steel with opening distance of 0 - 20 mm.
cat. no: 615.01.012

Stirrer stand is made from powder coated cast steel.

Unique base design offers very stable holding of the assembled stirrer and also possibility of getting close to the stand rod.

Supplied complete with 12 mm diameter st. steel support rod.
cat. no: 049.09.180

Bosshead clamp is specially suitable to hold light duty homogenizer.
cat. no: 621.11.103



For liquid / solid media
working volume: 0,1 - 50 ml
621.11.050



For liquid / solid media
working volume: 1 - 250 ml
621.11.250

stirring & mixing & shaking & heating & cooling

WATER BATHS

- Water tank is manufactured from cavitation-proof, seamless and corrosion resistant stainless steel.
- Alarm and timer functions can be automatically controlled by membrane keypad with digital LED panel.
- Integrated heater design provides homogenous heat distribution rate and enables rapid heating up.
- Integrated PID temperature technology enables excellent heating control from ambient +5°C to 99°C with accuracy of +/- 0,1°C.
- Integrated overheat protection with alarm circuit automatically turns off heating in case of overheating.
- Automatic timer with aural and visual alarm functions enables selective operation as "continuous" mode or 99 minutes and 99 hours.
- Perforated bottom tray protects heating element and temperature sensor.
- Delivered complete with flat type stainless steel lid.



Seamless, robust cavitation-proof, stainless steel water tank. Perforated bottom tray protects heating element and temperature sensor. Baths are supplied with a stainless steel flat lid.

| catalogue number | 602.01.001 | 602.02.001 |
|--------------------------|-------------------|-------------------|
| external dimensions (mm) | 327 x 265 x 280 | 537 x 327 x 280 |
| tank dimensions (mm) | 300 x 240 x 150 | 500 x 295 x 150 |
| tank volume (L) | 11 | 22 |
| heating output (W) | 700 | 1400 |
| heating range (°C) | ambient + 5 to 99 | ambient + 5 to 99 |
| heating control | PID technology | PID technology |
| heating accuracy (°C) | ±0,1 | ±0,1 |
| tank temp. uniformity | ±1 | ±1 |
| voltage (V) | 220 | 220 |
| frequency (Hz) | 50/60 | 50/60 |
| time & temp. display | LED | LED |
| time control | 99 min. - 99 hour | 99 min. - 99 hour |
| over heat protection | yes | yes |
| standard accesories | st. steel lid | st. steel lid |



Membrane keypad with digital LED panel with timer, alarm and auto-tuning functions. Timer with delayed on/off function can be set selectively either to 99 min. 59 sec. or 99 hour 59 min.

WATER CONDITIONER

- Highly effective special softener for water baths.
- Extremely gentle on ware with almost neutral pH value.
- Fully water soluble, low-foaming, low phosphate content, non-combustible, no gas formation, non-aggressive, biodegradable.
- Recommended 2 ml added to each 1 lt exchanged water.

| catalogue number | pack quantity |
|------------------|---------------|
| 602.01.101 | 500 ml bottle |



Recommended 5 ml added to 1 liter new changed fresh water.



HEATING MANTLES - "without stirrer"

- Designed heating and boiling liquids in various size of round bottom flasks from 100 ml to 10.000 ml.
- Time proportional heater control with excellent repeatability enables a temperature operating range to 450°C.
- Heating element is made of highly flexible heat-resistant glass yarn which performs a maximum temperature of 900°C.
- Flexible heating element absorbs shocks, minimizing the risk of flask breakage and guarantees uniform heat distribution.
- Outer casing is manufactured from easy to clean powder coated steel.
- Glass fibre outer insulation with excellent ventilation slots keeps the outer casing cool at all times.
- Featured with non-skid rubber feet enabling perfect stability during operation.
- Control panel has separate indicator lamps for power and heat functions.



Heating element is made of highly flexible heat-resistant glass yarn which performs at maximum temperature of 900°C.

| catalogue no | 608.11.100 | 608.11.250 | 608.11.500 | 608.11.901 | 608.11.902 |
|---------------------|------------|------------|------------|------------|------------|
| Voltage | 220 V | | | | |
| Frequency | 50 Hz | | | | |
| Power | 100W | 150 W | 250 W | 350 W | 450 W |
| Max. Heating | 450°C | | | | |
| Capacity | 100 ml | 250 ml | 500 ml | 1000 ml | 2000 ml |



HEATING MANTLES - "with stirrer"

- Designed to control both heating power and stirring speed independently.
- Time proportional heater control with excellent repeatability enables a temperature control to 450°C.
- Heating element is made of highly flexible heat-resistant glass yarn which performs a maximum temperature of 900°C.
- Flexible heating element absorbs shocks, minimizing the risk of flask breakage and guarantees uniform heat distribution.
- Provides a stirring speed up to 1.400 rpm with an integrated magnetic stirrer.
- For effective stirring, place the correct model and size of magnetic stirrer into the flask and increase the stirring speed slowly from minimum level.
- Outer casing is manufactured from easy to clean powder coated steel.
- Glass fibre outer insulation with excellent ventilation slots keeps the outer casing cool at all times.
- Featured with non-skid rubber feet enabling perfect stability during operation.
- Control panel has separate indicator lamps for heating and stirring functions.

| catalogue no | 608.12.100 | 608.12.250 | 608.12.500 | 608.12.901 |
|---------------------|--------------|------------|------------|------------|
| voltage | 220 V | | | |
| frequency | 50 Hz | | | |
| power | 100 W | 150 W | 250 W | 350 W |
| max. heating | 450°C | | | |
| capacity | 100 ml | 250 ml | 500 ml | 1000 ml |
| stirring | 0 - 1400 rpm | | | |

stirring & mixing & shaking & heating & cooling



VORTEX MIXER - "advanced"

| | |
|--------------|--------------------|
| catalogue no | 622.01.001 |
| dimensions | 127x130x160 mm |
| weight | 3 kg |
| power | 60 W |
| voltage | 220 V |
| frequency | 50 / 60 Hz |
| motion | orbital |
| motion dia. | 4 mm |
| run time | continuous / touch |
| range | 0 - 2500 rpm |
| display | scale |

- Offers touch and continuous orbital mixing. Provides mixing with adjustable speed control from 0 to 3000 rpm.
- Guarantees perfect mixing of a 50 ml tube in 3 seconds.
- Unique counter-balance system creates maximum vortex power.
- Aluminium cast and silicone feet pads minimize the vibration avoiding "walking".
- Reliable and extremely quiet motor guarantees an even distributed mixing.
- Can be used both in cold rooms, incubators and anaerobic and aerobic chambers due to the small foot print and extremely compact design.



VORTEX MIXER - "LED display"

| | |
|--------------|--------------------|
| catalogue no | 622.03.001 |
| dimensions | 110x145x160 mm |
| weight | 3 kg |
| power | 20 W |
| voltage | 220 V |
| frequency | 50 / 60 Hz |
| motion | orbital |
| motion dia. | 5 mm |
| run time | continuous / touch |
| range | 0 - 3000 rpm |
| display | LED |

- Offers touch and continuous orbital mixing.
- Provides efficient mixing with infinitely adjustable electronic speed control from 0 to 3000 rpm.
- Operation time can be set and controlled electronically between 1 second to 100 minutes. User friendly large LED displays enable easy setting and reading of speed and time.
- Guarantees perfect mixing of a 50 ml tube in 5 seconds with 6 mm diameter orbital movement.
- Other technical specifications are same as 622.01.001.



VORTEX MIXER - "basic"

| | |
|--------------|---------------------|
| catalogue no | 622.02.001 |
| dimensions | 100 mm dia. x 78 mm |
| weight | 0,55 kg |
| power | 12 W |
| voltage | 100 - 240 V |
| frequency | 50 / 60 Hz |
| motion | orbital |
| motion dia. | 5.5 mm |
| run time | continuous / touch |
| range | 3000 rpm |
| display | N/A |

- Offers perfect orbital vortex mixing with a single touch. Provides efficient mixing with fixed speed of 3000 rpm.
- Guarantees perfect mixing of a 50 ml tube in 3 seconds with 5.5 mm diameter orbital movement.
- Unique counter-balance system creates maximum vortexing while minimizing the noise and vibration.
- Reliable and extremely quiet motor guarantees an even distributed mixing.
- Can be used in limited areas due to the small foot print and extremely compact design.



ISOLAB

Laborgeräte GmbH

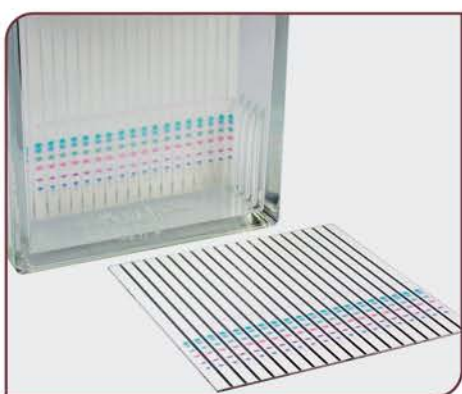

chromatography & spectroscopy



SYRINGE FILTERS - "non-sterile" - "sterile"

- Specially designed for HPLC sample preparations with the best quality tear proven membranes. Fully autoclavable.
- Since the housing is ultrasonically sealed they offer excellent pressure stability.
- Sample distribution rings of the body direct samples for uniform filtration with a guarantee of high flow rate and filtration speed on both directions restricting the liquid overload.
- Unique female luer-lock secures connections with syringes. Body design enables to be used with all robotic machines.
- Membrane type and porosity printed on each filter. Different colour coded sealing rings in MN enable easy differentiation of the membrane type.
- Available 2 filters:
 - Syringe filters with 0,45 µm pore size
 - Syringe filters with 0,22 µm pore size



| ISOLAB non-sterile 0,45 µm filters | MN non-sterile 0,45 µm filters | non-sterile pack quantity | MN sterile 0,45 µm filters | ISOLAB sterile 0,45 µm filters | sterile pack quantity | filter membrane material | code name | pore size µm | diameter |
|------------------------------------|--------------------------------|---------------------------|----------------------------|--------------------------------|-----------------------|--------------------------|-----------|--------------|----------|
| 094.01.001 | 094.02.001 | 100 pieces | | 094.05.001 | 50 pieces | regenerated cellulose | RC | 0.45 | 25 mm |
| 094.01.002 | 094.02.002 | 100 pieces | | 094.05.002 | 50 pieces | polytetrafluoroethylene | PTFE-1 | 0.45 | 25 mm |
| 094.01.003 | 094.02.003 | 100 pieces | | 094.05.003 | 50 pieces | polyvinylidenedifluoride | PVDF | 0.45 | 25 mm |
| | 094.02.004 | 100 pieces | | | | polyester | PET | 0.45 | 25 mm |
| 094.01.005 | 094.02.005 | 100 pieces | | 094.05.005 | 50 pieces | cellulosemixedesters | MV | 0.45 | 25 mm |
| 094.01.006 | 094.02.006 | 100 pieces | 094.06.006 | 094.05.006 | 50 pieces | cellulose acetate | CA | 0.45 | 25 mm |
| 094.01.007 | 094.02.007 | 100 pieces | | 094.05.007 | 50 pieces | nylon / polyamide | PA | 0.45 | 25 mm |
| 094.01.008 | 094.02.008 | 100 pieces | | 094.05.008 | 50 pieces | polyethersulfone | PES | 0.45 | 25 mm |
| 094.01.009 | | 100 pieces | | 094.05.009 | 50 pieces | polytetrafluoroethylene | PTFE-2 | 0.45 | 25 mm |

| ISOLAB non-sterile 0,22 µm filters | MN non-sterile 0,22 µm filters | non-sterile pack quantity | MN sterile 0,22 µm filters | ISOLAB sterile 0,22 µm filters | sterile pack quantity | filter membrane material | code name | pore size µm | diameter |
|------------------------------------|--------------------------------|---------------------------|----------------------------|--------------------------------|-----------------------|--------------------------|-----------|--------------|----------|
| 094.03.001 | 094.04.001 | 100 pieces | | 094.07.001 | 50 pieces | regenerated cellulose | RC | 0.22 | 25 mm |
| 094.03.002 | 094.04.002 | 100 pieces | | 094.07.002 | 50 pieces | polytetrafluoroethylene | PTFE-1 | 0.22 | 25 mm |
| 094.03.003 | 094.04.003 | 100 pieces | | 094.07.003 | 50 pieces | polyvinylidenedifluoride | PVDF | 0.22 | 25 mm |
| | 094.04.004 | 100 pieces | | | | polyester | PET | 0.22 | 25 mm |
| 094.03.005 | 094.04.005 | 100 pieces | | 094.07.005 | 50 pieces | cellulosemixedesters | MV | 0.22 | 25 mm |
| 094.03.006 | 094.04.006 | 100 pieces | 094.08.006 | 094.07.006 | 50 pieces | cellulose acetate | CA | 0.22 | 25 mm |
| 094.03.007 | 094.04.007 | 100 pieces | | 094.07.007 | 50 pieces | nylon / polyamide | PA | 0.22 | 25 mm |
| 094.03.008 | 094.04.008 | 100 pieces | | 094.07.008 | 50 pieces | polyethersulfone | PES | 0.22 | 25 mm |
| 094.03.009 | | 100 pieces | | 094.07.009 | 50 pieces | polytetrafluoroethylene | PTFE-2 | 0.22 | 25 mm |

MV = cellulose mixed esters, **CA** = cellulose acetate, **RC** = regenerated cellulose, **PA** = polyamide, **PTFE-1** = polytetrafluoroethylene hydrophobic, **PTFE-2** = polytetrafluoroethylene hydrophilic, **PVDF** = polyvinylidene difluoride, **PES** = polyethersulfone, **PET** = polyester

SYRINGES - "polypropylene" - "sterile"

- 2 pieces syringes are suitable for HPLC applications. Sterile, pyrogen-free and for single use, latex and silicone oil free.
- Consists of very clear, highly transparent and absolutely leak-tight polypropylene barrel and polyethylene piston.
- Ergonomically designed for single-handed operation. Featured with accurate graduated scale marking.
- Smooth piston movement offers reduced sliding force.
- Defined position at "0" volume level to feel when piston is completely inserted.
- Defined safety stop to avoid accidental pull-out of plunger and loss of sample.
- Supplied with syringe needles. Packed in individual blister packing.



| catalogue number | volume | overall length | pack quantity |
|------------------|--------|----------------|---------------|
| 094.91.002 | 2 ml | 87 mm | 300 pieces |
| 094.91.005 | 5 ml | 87 mm | 225 pieces |
| 094.91.010 | 10 ml | 100 mm | 150 pieces |
| 094.91.020 | 20 ml | 115 mm | 100 pieces |



MEMBRANE FILTERS



➤ Membrane filtration offer a very convenient, fast and economical separation method.

They offer below mentioned advantages;

- ✓ Excellent level of particle retention
- ✓ Large load carry capacity
- ✓ High permeability to air
- ✓ Non-hygroscopic and biologically inert
- ✓ Chemical resistance to most solvents and reagents.
- ✓ Very high temperature resistance

CM: cellulose mixed ester membrane
Particularly suitable for aqueous solutions. They are hydrophilic. Thermally stable to 121°C. Ideal for gravimetric analysis and are often used for contamination tests.

NC: nitrocellulose membranes
They are easily wettable and suited for filtration of aqueous solutions. In dry atmosphere these membranes are thermally stable at 125°C and can be autoclaved at 121°C.

RC: regenerated cellulose membranes
These membranes are resistant to most organic solvents. They are mostly used for filtration of solvent mixtures and ultra-purification and degassing of HPLC eluents.

PTFE: polytetrafluoroethylene membranes
Particularly suitable with aggressive media, as well as to concentrated acids and bases. They are hydrophobic, they can be used up to 145°C.

PE: polyester membranes
They are hydrophilic. Particularly suitable for fine titration, dust analysis, aerosol analysis and ultra-purification of solvents.

CA: cellulose acetate membranes
They have a low protein binding capacity and they are suited for aqueous and alcoholic media. They are hydrophobic and can be used for hot gases up to 180°C.

GF/C: glass fibre filter
Suitable for determination of liquid scintillation counting and total suspended solids collection in potable water and in industrial waste. Grade 50C glass fibre filters are hydrophilic and medium / fast, very high loading. They resist temperatures up to 500°C.

| catalogue number | membrane material | code name | pore size | type | diameter | pack quantity |
|------------------|-------------------------|-----------|-----------|------|----------|---------------|
| 104.01.001 | cellulose mixed ester | CM | 0,20 µm | 1 | 47 mm | 100 pieces |
| 104.01.002 | cellulose mixed ester | CM | 0,45 µm | 1 | 47 mm | 100 pieces |
| 104.01.003 | nitrocellulose | NC | 0,20 µm | 1 | 47 mm | 100 pieces |
| 104.01.004 | nitrocellulose | NC | 0,45 µm | 1 | 47 mm | 100 pieces |
| 104.01.005 | regenerated cellulose | RC | 0,20 µm | 1 | 47 mm | 100 pieces |
| 104.01.006 | regenerated cellulose | RC | 0,45 µm | 1 | 47 mm | 100 pieces |
| 104.01.007 | polytetrafluoroethylene | PTFE | 0,20 µm | 1 | 47 mm | 100 pieces |
| 104.01.008 | polytetrafluoroethylene | PTFE | 0,45 µm | 1 | 47 mm | 100 pieces |
| 104.01.009 | polyester | PE | 0,20 µm | 1 | 47 mm | 100 pieces |
| 104.01.010 | polyester | PE | 0,45 µm | 1 | 47 mm | 100 pieces |
| 104.01.011 | cellulose acetate | CA | 0,20 µm | 1 | 47 mm | 100 pieces |
| 104.01.012 | cellulose acetate | CA | 0,45 µm | 1 | 47 mm | 100 pieces |
| 104.01.013 | glass fibre | GF/C | 1,20 µm | 2 | 47 mm | 100 pieces |

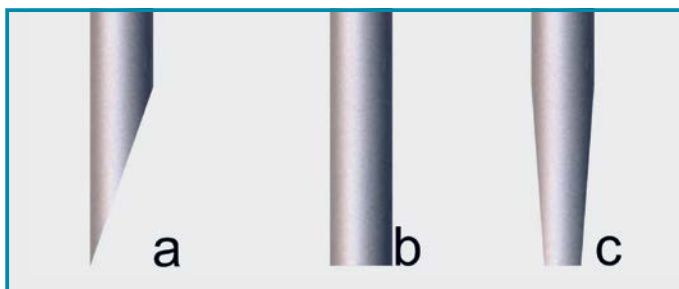

“A” type needles are designed for optimum penetration with 17° bevel. Also minimizes the necessary piercing force and diameter of injection channel.

“B” type needles has a 90° bevel for precise pipetting. This design releases drops completely, for maximum reproducibility. Ideal for HPLC sample injection.

“C” type needles are designed for autosamplers. The tapered tip and the 90° square end eliminate burns. Ideal for PTFE laminated seals and regular septas.

SYRINGES - “for dosage of liquids” - “0 dead volume needle” - “serie T”



Plunger: stainless steel (plunger runs inside the needle)

Barrel: borosilicate glass

Precision: < +/- 1% of the volume

Main use: sample dosage for gas chromatography & dosage of small volume samples & for thin layer chromatography

| syringe volume | catalogue number | needle type | catalogue number | needle type | pack quantity |
|----------------|------------------|-------------|------------------|-------------|---------------|
| 0,5 µl | 094.31.005 | A | 094.32.005 | B | 1 piece |
| 1,0 µl | 094.31.010 | A | 094.32.010 | B | 1 piece |
| 2,0 µl | 094.31.020 | A | 094.32.020 | B | 1 piece |
| 5,0 µl | 094.31.050 | A | 094.32.050 | B | 1 piece |
| 10 µl | 094.31.100 | A | 094.32.100 | B | 1 piece |
| 25 µl | 094.31.250 | A | 094.32.250 | B | 1 piece |

SYRINGES - “for dosage of liquids” – “fixed needle” – “serie FN”

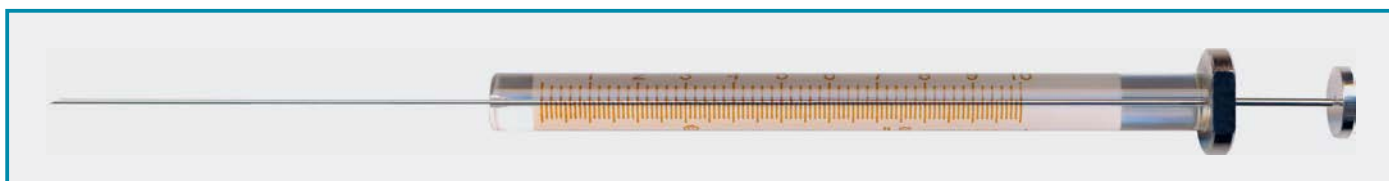

Plunger: stainless steel

Barrel: borosilicate glass

Precision: < +/- 1% of the volume

Main use: sample dosage for gas chromatography & HPLC valves & autosamplers

| syringe volume | catalogue number | needle type | catalogue number | needle type | catalogue number | needle type | pack quantity |
|----------------|------------------|-------------|------------------|-------------|------------------|-------------|---------------|
| 5 µl | 094.11.005 | A | 094.12.005 | B | 094.13.005 | C | 1 piece |
| 10 µl | 094.11.010 | A | 094.12.010 | B | 094.13.010 | C | 1 piece |
| 25 µl | 094.11.025 | A | 094.12.025 | B | 094.13.025 | C | 1 piece |
| 50 µl | 094.11.050 | A | 094.12.050 | B | 094.13.050 | C | 1 piece |
| 100 µl | 094.11.100 | A | 094.12.100 | B | 094.13.100 | C | 1 piece |
| 250 µl | 094.11.250 | A | 094.12.250 | B | 094.13.250 | C | 1 piece |
| 500 µl | 094.11.500 | A | 094.12.500 | B | 094.13.500 | C | 1 piece |

SYRINGES - “for dosage of liquids” – “removable needle” – “serie RN”



Plunger: stainless steel

Barrel: borosilicate glass

Precision: < +/- 1% of the volume

Main use: sample dosage for gas chromatography & HPLC valves & autosamplers

| syringe volume | catalogue number | needle type | catalogue number | needle type | pack quantity |
|----------------|------------------|-------------|------------------|-------------|---------------|
| 5 µl | 094.21.005 | A | 094.22.005 | B | 1 piece |
| 10 µl | 094.21.010 | A | 094.22.010 | B | 1 piece |
| 25 µl | 094.21.025 | A | 094.22.025 | B | 1 piece |
| 50 µl | 094.21.050 | A | 094.22.050 | B | 1 piece |
| 100 µl | 094.21.100 | A | 094.22.100 | B | 1 piece |
| 250 µl | 094.21.250 | A | 094.22.250 | B | 1 piece |
| 500 µl | 094.21.500 | A | 094.22.500 | B | 1 piece |

SYRINGES - "for dosage of gas & liquids" – "fixed needle" – "serie H"



Plunger: stainless steel with PTFE seal

Barrel: borosilicate glass

Precision: < +/- 1% of the volume

Main use: sample dosage for gas chromatography & HPLC valves & autosamplers & dosage of aggressive fluids

| syringe volume | catalogue number | needle type | catalogue number | needle type | pack quantity |
|----------------|------------------|-------------|------------------|-------------|---------------|
| 5 µl | 094.41.005 | A | 094.42.005 | B | 1 piece |
| 10 µl | 094.41.010 | A | 094.42.010 | B | 1 piece |
| 25 µl | 094.41.025 | A | 094.42.025 | B | 1 piece |
| 50 µl | 094.41.050 | A | 094.42.050 | B | 1 piece |
| 100 µl | 094.41.100 | A | 094.42.100 | B | 1 piece |
| 250 µl | 094.41.250 | A | 094.42.250 | B | 1 piece |
| 500 µl | 094.41.500 | A | 094.42.500 | B | 1 piece |
| 1,0 ml | 094.41.901 | A | 094.42.901 | B | 1 piece |
| 2,5 ml | 094.41.902 | A | 094.42.902 | B | 1 piece |
| 5,0 ml | 094.41.905 | A | 094.42.905 | B | 1 piece |
| 10,0 ml | 094.41.910 | A | 094.42.910 | B | 1 piece |

SYRINGES - "for dosage of gas & liquids" – "removable needle" – "serie H"



Plunger: stainless steel with PTFE seal

Barrel: borosilicate glass

Precision: < +/- 1% of the volume

Main use: sample dosage for gas chromatography & HPLC valves & autosamplers & dosage of aggressive fluids

| syringe volume | catalogue number | needle type | catalogue number | needle type | pack quantity |
|----------------|------------------|-------------|------------------|-------------|---------------|
| 5 µl | 094.51.005 | A | 094.52.005 | B | 1 piece |
| 10 µl | 094.51.010 | A | 094.52.010 | B | 1 piece |
| 25 µl | 094.51.025 | A | 094.52.025 | B | 1 piece |
| 50 µl | 094.51.050 | A | 094.52.050 | B | 1 piece |
| 100 µl | 094.51.100 | A | 094.52.100 | B | 1 piece |
| 250 µl | 094.51.250 | A | 094.52.250 | B | 1 piece |
| 500 µl | 094.51.500 | A | 094.52.500 | B | 1 piece |
| 1,0 ml | 094.51.901 | A | 094.52.901 | B | 1 piece |
| 2,5 ml | 094.51.902 | A | 094.52.902 | B | 1 piece |
| 5,0 ml | 094.51.905 | A | 094.52.905 | B | 1 piece |
| 10,0 ml | 094.51.910 | A | 094.52.910 | B | 1 piece |

SYRINGES - "glass" - "with luer-lock"



➤ Manufactured from borosilicate glass. Featured with a stainless steel luer-lock system.

➤ Luer-lock grabs the needle or syringe filter stem and guarantees leak-proof delivery of the liquid even under high pressure.

➤ Luer-Barrel and the piston can be repeatedly autoclavable.

➤ Ergonomically designed for single-handed operation.

➤ Smooth piston movement offers reduced sliding force.

| catalogue number | volume | overall length | pack quantity |
|------------------|--------|----------------|---------------|
| 094.92.001 | 1 ml | 85 mm | 1 piece |
| 094.92.005 | 5 ml | 105 mm | 1 piece |
| 094.92.010 | 10 ml | 130 mm | 1 piece |
| 094.92.020 | 20 ml | 145 mm | 1 piece |
| 094.92.050 | 50 ml | 180 mm | 1 piece |

CHROMATOGRAPHY VIALS & SEPTAS & CAPS

In chromatography a wide variety of vials are used as sample containers. As they are mainly used by automatic instruments strict obedience of all dimensions is essential for trouble-free tests. Besides of these physical properties the vials have to fulfill requirements regarding inertness and cleanliness.



chromatography vials

- ✓ Vials are either manufactured from glass or plastic. Glass vials are manufactured from 1st hydrolic glass tubings with low expansion coefficient.
- ✓ Hydrolic glass quality offers perfect resistance to all chemicals and higher hydrolic resistance.
- ✓ Plastic vials are manufactured from polypropylene with a very good resistance to most of the chemicals and high hydrolic resistance.



vial cap without slit

vial cap with slit

septas & caps

- ✓ Sealing units for vials are combination of caps and septas. Caps can be offered either with slit or without slit.
- ✓ For problem-free and correct results seals should also be inert and uncontaminated.
- ✓ Almost all septa are laminated on one side with PTFE, which has a high chemical resistance and forms an inert barrier between the sample in the vial and the cap of the septa.



vial packing

- ✓ Some vials (specially small size ones such as N8, N9 and N11) are packed in a polystyrene boxes.
- ✓ This kind of packing provides guarantees protection against dust and other enviromental effects.
- ✓ The glass clear polystyrene box makes the vials always clearly visible at all times.



cap packing

- ✓ Caps are usually packed in tamper-proof evident zip-locked bags.
- ✓ These bags allow easy identification of the content due to the transparent P.E material.
- ✓ The zip-lock enables resealing of the bag after used.

VIALS - "glass" - "screw cap" - "N8"



► Manufactured from hydrolic No:1 glass. Supplied without caps & septas.

► Offers perfect shape, very low dimensional tolerance and exact wall thickness for optimum performance.

► Featured with volume graduations and marking area.

| catalogue number | vial dimensions | volume | color | pack quantity |
|------------------|-----------------|--------|-------|---------------|
| 095.00.001 | 11,6 x 32 mm | 1,5 ml | clear | 100 pieces |
| 095.00.002 | 11,6 x 32 mm | 1,5 ml | amber | 100 pieces |

VIALS - "glass" - "screw cap" - "N9"



► Manufactured from hydrolic No:1 glass. Supplied without caps & septas.

► Offers perfect shape, very low dimensional tolerance and exact wall thickness for optimum performance.

► Featured with volume graduations and marking area.

| catalogue number | vial dimensions | volume | color | pack quantity |
|------------------|-----------------|--------|-------|---------------|
| 095.01.001 | 11,6 x 32 mm | 1,5 ml | clear | 100 pieces |
| 095.01.002 | 11,6 x 32 mm | 1,5 ml | amber | 100 pieces |



INSERTS - "glass" "for N8 size vials"

► Manufactured from hydrolic No:1 glass with perfect shape.

► Very low dimensional tolerance and exact wall thickness for perfect fit to vials with N8 neck size.

► Offers perfect solutions for applications where sample volume is limited.

| catalogue number | product specifications | volume | vial dimensions | pack quantity |
|------------------|------------------------|---------|-----------------|---------------|
| 097.05.106 | conical bottom | 0,1 ml | 5,0x31,0 mm | 100 pieces |
| 097.05.107 | with P.P spring | 0,1 ml | 5,0x29,0 mm | 100 pieces |
| 097.05.108 | flat bottom | 0,25 ml | 5,0x31,5 mm | 100 pieces |

CAPS & SEPTAS - "for N8 vials"



► Offer optimum system performance. Designed to work excellently with needles. All of them are specially sized for proper sealings.

► Packed in tamper-proof evident, transparent, zip-locked bags that allow easy identification.

| catalogue number | product specifications | pack quantity |
|------------------|--------------------------------|---------------|
| 096.00.001 | silicone / PTFE - without slit | 100 pieces |
| 096.00.002 | silicone / PTFE - with slit | 100 pieces |

CAPS & SEPTAS - "for N9 vials"



► Offer optimum system performance. Designed to work excellently with needles. All of them are specially sized for proper sealings.

► Packed in tamper-proof evident, transparent, zip-locked bags that allow easy identification.

| for N9 vials | product specifications | pack quantity |
|--------------|--------------------------------|---------------|
| 096.01.001 | silicone / PTFE - without slit | 100 pieces |
| 096.01.002 | silicone / PTFE - with slit | 100 pieces |
| 096.01.004 | silicone / PTFE - cross slit | 100 pieces |



INSERTS - "glass" "for N9 size vials"

► Manufactured from hydrolic No:1 glass with perfect shape.

► Very low dimensional tolerance and exact wall thickness for perfect fit to vials with N9 neck size.

► Offer perfect solutions for applications where sample volume is limited.

| catalogue number | product specifications | volume | vial dimensions | pack quantity |
|------------------|------------------------|--------|-----------------|---------------|
| 097.05.110 | conical bottom | 0,2 ml | 6,0x31,0 mm | 100 pieces |
| 097.05.111 | with P.P spring | 0,1 ml | 5,7x29,0 mm | 100 pieces |
| 097.05.109 | flat bottom | 0,3 ml | 5,8x31,5 mm | 100 pieces |

VIALS - "glass" - "crimp cap" - "N11"



► Manufactured from hydrolic No:1 glass. Supplied without caps & septas.

► Offers perfect shape, very low dimensional tolerance and exact wall thickness for optimum performance.

► Featured with volume graduations and marking area.

CAPS & SEPTAS - "for N11 vials"



► Offer optimum system performance. Designed to work excellently with needles. All of them are specially sized for proper sealings.

► Packed in tamper-proof evident, transparent, zip-locked bags that allow easy identification.

| catalogue number | vial dimensions | volume | color | pack quantity |
|------------------|-----------------|--------|-------|---------------|
| 095.02.001 | 11,6 x 32 mm | 1,5 ml | clear | 100 pieces |
| 095.02.002 | 11,6 x 32 mm | 1,5 ml | amber | 100 pieces |

| catalogue number | cap type | product specifications | pack quantity |
|------------------|----------|--------------------------------|---------------|
| 096.02.001 | crimp | silicone / PTFE - without slit | 100 pieces |
| 096.02.002 | crimp | rubber / TEF - without slit | 100 pieces |

VIALS - "glass" - "screw cap" - "N13"



► Manufactured from hydrolic No:1 glass with perfect shape, very low dimensional tolerance and exact wall thickness for optimum performance.

| catalogue number | vial dimensions | volume | color | pack quantity |
|------------------|-----------------|--------|-------|---------------|
| 095.05.001 | 14,75 x 45 mm | 4,0 ml | clear | 100 pieces |
| 095.05.002 | 14,75 x 45 mm | 4,0 ml | amber | 100 pieces |

CAPS & SEPTAS



► Offer optimum system performance. Designed to work excellently with needles. All of them are specially sized for proper sealings. Packed in tamper-proof evident, transparent, zip-locked bags.

| catalogue number | product specifications | pack quantity |
|------------------|--------------------------------|---------------|
| 096.05.003 | silicone / PTFE - without slit | 100 pieces |
| 096.05.004 | rubber / FEP - without slit | 100 pieces |



VIALS - "glass" - "screw cap" - "N15"



► Manufactured from hydrolic No:1 glass with perfect shape, very low dimensional tolerance and exact wall thickness for optimum performance.

| catalogue number | vial dimensions | volume | color | pack quantity |
|------------------|-----------------|---------|-------|---------------|
| 095.06.001 | 18,5 x 66 mm | 12,0 ml | clear | 100 pieces |
| 095.06.002 | 18,5 x 66 mm | 12,0 ml | amber | 100 pieces |

CAPS & SEPTAS



► Offer optimum system performance. Designed to work excellently with needles. All of them are specially sized for proper sealings.

► Packed in tamper-proof evident, transparent, zip-locked bags that allow easy identification.

| catalogue number | product specifications | pack quantity |
|------------------|--|---------------|
| 095.06.003 | white septum / beige PTFE - without hole | 100 pieces |





VIALS - "glass" - "screw cap" - "N20"

- Manufactured from hydrolic No:1 glass. Supplied without caps & septas.
- Offers perfect shape, very low dimensional tolerance and exact wall thickness for optimum performance.

| catalogue number | vial dimensions | volume | color | pack quantity |
|------------------|-----------------|---------|-------|---------------|
| 095.03.001 | 22,7 x 86,0 mm | 22,0 ml | clear | 100 pieces |
| 095.03.002 | 22,7 x 86,0 mm | 22,0 ml | amber | 100 pieces |

CAPS & SEPTAS - "for N20 vials"



- Offer optimum system performance. Designed to work excellently with needles. All of them are specially sized for proper sealings.
- Packed in tamper-proof evident, transparent, zip-locked bags that allow easy identification.

| catalogue number | product specifications | pack quantity |
|------------------|--------------------------------|---------------|
| 096.05.001 | silicone / PTFE - without hole | 100 pieces |



VIALS - "glass" - "crimp cap" - "N20"

- Manufactured from hydrolic No:1 glass. Supplied without caps & septas.
- Offers perfect shape, very low dimensional tolerance and exact wall thickness for optimum performance.

| catalogue number | vial dimensions | volume | color | pack quantity |
|------------------|-----------------|---------|-------|---------------|
| 095.03.003 | 20,5 x 54,5 mm | 10,0 ml | clear | 100 pieces |
| 095.03.004 | 20,5 x 54,5 mm | 10,0 ml | amber | 100 pieces |
| 097.03.001 | 22,5 x 46,0 mm | 10,0 ml | clear | 100 pieces |
| 097.03.002 | 22,5 x 46,0 mm | 10,0 ml | amber | 100 pieces |
| 097.04.001 | 22,5 x 75,5 mm | 20,0 ml | clear | 100 pieces |
| 097.04.002 | 22,5 x 75,5 mm | 20,0 ml | amber | 100 pieces |

CAPS & SEPTAS - "for N20 crimp vials"



- Offer optimum system performance. Designed to work excellently with needles. All of them are specially sized for proper sealings.
- Packed in tamper-proof evident, transparent, zip-locked bags that allow easy identification.

| catalogue number | product specifications | pack quantity |
|------------------|--------------------------------|---------------|
| 096.03.001 | silicone / PTFE - without slit | 100 pieces |



VIALS - "glass" - "screw cap" - "N24"

- ▶ Manufactured from hydrolic No:1 glass. Supplied without caps & septas.
- ▶ Offers perfect shape, very low dimensional tolerance and exact wall thickness for optimum performance.

| catalogue number | vial dimensions | volume | color | pack quantity |
|------------------|-----------------|---------|-------|---------------|
| 095.03.011 | 27,5 x 95,0 mm | 40,0 ml | clear | 100 pieces |
| 095.03.012 | 27,5 x 95,0 mm | 40,0 ml | amber | 100 pieces |

CAPS & SEPTAS - "for N24 vials"



- ▶ Designed to work excellently with needles. Specially sized for proper sealings. Packed in tamper-proof evident, transparent, zip-locked bags that allow easy identification of interior.

| catalogue number | product specifications | pack quantity |
|------------------|--------------------------------|---------------|
| 096.05.011 | silicone / PTFE - without hole | 100 pieces |
| 096.05.012 | silicone / PTFE - with hole | 100 pieces |



Offers adjustable crimping pressure by an easily accessible and well visible knob on the crimping head.

CRIMPERS & DECAPPERS - "manual"

- ▶ Manual crimpers and decappers are much lighter than the standard alternatives. They never create fatigue after long extended working periods.
- ▶ Ergonomical design offers improved comfort over blocky metal grips.
- ▶ Offers adjustable crimping pressure by a easily accessible and well visible knob on the crimping head.
- ▶ Activated by bottom handle motion guarantees faster and safer hold of the tool during crimping.
- ▶ Due to the design of the crimper head better vertical clearance over the vial is assured.



Bottom pull handle design for faster and safer hold of the tool during crimping and decapping.

| catalogue number | product descriptions | pack quantity |
|------------------|--------------------------|---------------|
| 097.01.011 | crimper - for N 11 caps | 1 piece |
| 097.01.020 | crimper - for N 20 caps | 1 piece |
| 097.02.011 | decapper - for N 11 caps | 1 piece |
| 097.02.020 | decapper - for N 20 caps | 1 piece |

RACKS / WORKSTATIONS "for vial"

- Manufactured from polycarbonate with high mechanical strength.
- Uniquely designed to carry 50 pieces of 2,0 ml & 5,0 ml volume vials in 10 x 5 array.
- Optimum design of the wells keeps the vials at their positions firmly and vertical.
- Alphanumerical index on vial rows enables easy identification of vial positions.
- Featured with a frosted write on and labelling area at the front side of the workstation.

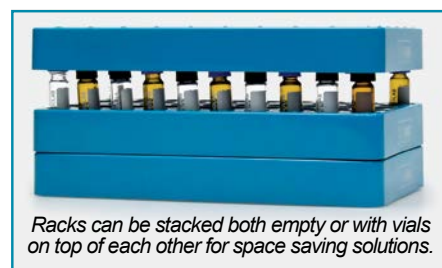

Racks can be stacked both empty or with vials on top of each other for space saving solutions.



| catalogue number | for vials diameter | well quantity | vial array | L x W x H | rack color | pack quantity |
|------------------|--------------------|---------------|------------|---------------|------------|---------------|
| 095.95.001 | 11,60 mm | 50 | 5 x 10 | 110x195x22 mm | blue | 1 piece |
| 095.95.002 | 14,75 mm | 50 | 5 x 10 | 115x240x30 mm | dark blue | 1 piece |

TUBE BOX - "100 well" - "hinged lid"

- Manufactured from autoclavable polypropylene with high mechanical strength. Guarantees high temperature resistance between -20°C to +121°C.
- Uniquely designed to carry 100 vials with 11,0 - 12,0 mm diameter in 10 x 10 array. Easily stackable for reducing storage space.
- Hinged lid with built-in stop allows easy one-handed operation and access to vials.
- Clear box lid enables easy identification of box content and protects the vials from dust and other environmental effects.
- Different color options offer visual sorting and organising of different vials.
- Alphanumerical index both on tube rows and the lid enables easy identification of tube positions.



| catalogue number | lid type | for vials diameter | well quantity | vial array | L x W x H | rack color | pack quantity |
|------------------|----------|--------------------|---------------|------------|---------------|------------|---------------|
| 080.01.002B | hinged | 11,6 mm | 100 | 10 x 10 | 141x151x53 mm | blue | 1 piece |
| 080.01.002P | hinged | 11,6 mm | 100 | 10 x 10 | 141x151x53 mm | purple | 1 piece |
| 080.01.002R | hinged | 11,6 mm | 100 | 10 x 10 | 141x151x53 mm | ruby | 1 piece |



Clear box lid provides protection of vials from environmental effects.



Alphanumerical index enables easy identification of vial positions.



Different colors offer visual sorting and organising of different samples.



Corner frames enable perfect stacking on each other without sliding.



CUVETTES - "polystyrene" - "12,5 x 12,5 x 45 mm"

- Manufactured from glass-clear polystyrene with 12,5 x 12,5 x 45 mm overall dimensions as single use.
- Can be both used for chemistry and life science applications.
- Wavelength operating range from 340 to 900 nm. Offers a light path of 10 mm with clear and clean optical path length.
- Optimised shape and narrow wall thickness provide increased heat transfer resulting in more constant sample temperatures during measurements.
- Grouped by mould cavity and packed in same box to ensure lowest variation of absorption coefficient.
- Eliminates cross contamination risk associated with washing and re-using such as glass cuvettes.
- Available 2 cuvettes:
 - Macro cuvettes
 - Semi-micro cuvettes
- Supplied as 100 cuvettes packed in a styrofoam box with a cover.

| catalogue number | cuvette type | product descriptions | material | wavelength range | light path | volume | internal width | pack quantity |
|------------------|--------------|-------------------------------|-------------|------------------|------------|------------|----------------|---------------|
| 098.02.002 | macro | with clear wall & without cap | polystyrene | 340 - 900 nm | 10 mm | 2,5-4,5 ml | 10 mm | 100 pieces |
| 098.02.001 | semi-micro | with clear wall & without cap | polystyrene | 340 - 900 nm | 10 mm | 1,5-3,0 ml | 4 mm | 100 pieces |



CUVETTES - "glass" - "12,5 x 12,5 x 45 mm"

- Manufactured from polished quartz glass or polished optical glass with 12,5 x 12,5 x 45 mm dimensions as multi-use.
- They offer clear and clean optical path length and fit to all standard spectrophotometer cuvette holders.
- Can be both used for chemistry and life science applications.
- Quartz cuvettes provide wavelength operating range from 190 to 2.500 nm.
- Optical glass cuvettes provide wavelength operating range from 340 to 2.500 nm.
- Optimised shape, precise dimensions with tolerance less than 0,1 % mm and excellent wall thickness provide accurate results during measurements.
- Available 3 cuvettes:
 - Macro cuvettes
 - Semi-micro cuvettes
 - Micro cuvettes
- Supplied as 2 cuvettes packed in a polystyrene box for protection from dust and other environmental effects.

| catalogue number | cuvette type | product descriptions | material | wavelength range | light path | volume | internal width | pack quantity |
|------------------|--------------|------------------------------|---------------|------------------|------------|---------|----------------|---------------|
| 098.01.001 | macro | with clear wall & PTFE cap | ES Quartz | 190 - 2500 nm | 10 mm | 3,50 ml | 10 mm | 2 pieces |
| 098.01.002 | semi-micro | with frosted wall & PTFE cap | ES Quartz | 190 - 2500 nm | 10 mm | 1,40 ml | 4 mm | 2 pieces |
| 098.01.003 | micro | with frosted wall & PTFE cap | ES Quartz | 190 - 2500 nm | 10 mm | 0,70 ml | 2 mm | 2 pieces |
| 098.01.004 | macro | with clear wall & PTFE cap | optical glass | 340 - 2500 nm | 10 mm | 3,50 ml | 10 mm | 2 pieces |
| 098.01.005 | semi-micro | with frosted wall & PTFE cap | optical glass | 340 - 2500 nm | 10 mm | 1,40 ml | 4 mm | 2 pieces |
| 098.01.006 | micro | with frosted wall & PTFE cap | optical glass | 340 - 2500 nm | 10 mm | 0,70 ml | 2 mm | 2 pieces |

CUVETTES - "glass" - "12,5 x 52,5 x 45 mm"

- Manufactured from polished quartz glass or polished optical glass with 12,5 x 52,5 x 45 mm dimensions as multi-use for chemistry and life science applications.
- They offer clear and clean optical path length and fit to all standard spectrophotometer cuvette holders.
- Quartz cuvettes provide wavelength operating range from 190 to 2.500 nm.
- Optical glass cuvettes provide wavelength operating range from 340 to 2.500 nm.
- Optimised shape, precise dimensions with tolerance less than 0,1 % mm and excellent wall thickness provide accurate resulting during measurements.
 - **Macro cuvettes**
 - **Available 3 cuvettes:**
 - **Semi-micro cuvettes**
 - **Micro cuvettes**
- Supplied as 2 cuvettes packed in a polystyrene box for protection from dust and other environmental effects.



| catalogue number | cuvette type | product descriptions | material | wavelength range | light path | volume | internal width | pack quantity |
|------------------|--------------|------------------------------|---------------|------------------|------------|---------|----------------|---------------|
| 098.01.007 | macro | with clear wall & PTFE cap | ES Quartz | 190 - 2500 nm | 50 mm | 17,5 ml | 10 mm | 1 piece |
| 098.01.008 | semi-micro | with frosted wall & PTFE cap | ES Quartz | 190 - 2500 nm | 50 mm | 7,00 ml | 4 mm | 2 pieces |
| 098.01.009 | micro | with frosted wall & PTFE cap | ES Quartz | 190 - 2500 nm | 50 mm | 3,50 ml | 2 mm | 2 pieces |
| 098.01.010 | macro | with clear wall & PTFE cap | optical glass | 340 - 2500 nm | 50 mm | 17,5 ml | 10 mm | 1 piece |
| 098.01.011 | semi-micro | with frosted wall & PTFE cap | optical glass | 340 - 2500 nm | 50 mm | 7,00 ml | 4 mm | 2 pieces |
| 098.01.012 | micro | with frosted wall & PTFE cap | optical glass | 340 - 2500 nm | 50 mm | 3,50 ml | 2 mm | 2 pieces |

BOX - "for cuvettes"

- Manufactured from polypropylene with 120x112x60 mm dimensions for safe handling and holding 12 cuvettes with 10 mm width.
- Hinged lid secures clasps and offers convenient use of the box. Removable cuvette insert helps easy cleaning.
- The inside height designed to accommodate all cuvettes.

| catalogue number | box color | pack quantity |
|------------------|-----------|---------------|
| 098.03.001B | blue | 1 piece |
| 098.03.001P | purple | 1 piece |
| 098.03.001R | ruby | 1 piece |



RACK - "for cuvettes"

- Manufactured from polypropylene with 210x70x35 mm dimensions for safe handling and holding 16 cuvettes with 10 mm width.
- Alphanumeric index on cuvette rows enables easy identification of tube positions.
- 2 tier body form offers clear visibility option from horizontal direction.

| catalogue number | box color | pack quantity |
|------------------|-----------|---------------|
| 098.03.002B | blue | 1 piece |
| 098.03.002P | purple | 1 piece |
| 098.03.002R | ruby | 1 piece |



TLC SEPARATION TANK

➤ TLC developing tanks are used to run up to 5 TLC plates for separation. The tank can be equilibrated for 30 minutes prior to running the plate to yield good result. TLC Developing tank supplied to gather with the lid.

➤ Rectangular shaped TLC developing tanks are used to develop 20x20 cm TLC plates.

| catalogue number | pack quantity |
|------------------|---------------|
| 108.01.016 | 1 piece |



TLC PLATES

➤ Silica 60, specific surface (BET) - 500 m²/g, mean pore size 60Å, specific pore volume 0,75 ml/g, particle size 5 - 17 µm standard grade. Binders: highly polymeric products, which are stable in almost all organic solvents and resistant towards aggressive visualisation reagents.

| catalogue number | product descriptions | material | dimensions | thickness of layer | pack quantity |
|------------------|--------------------------------------|-----------------|------------|--------------------|---------------|
| 108.01.001 | TLC precoated plates SIL G-25 | glass sheet | 20 x 20 cm | 0,25 mm | 25 pieces |
| 108.01.015 | ALUGRAM™ Xtra™ sheets SIL G / UV 254 | aluminium sheet | 20 x 20 cm | 0,20 mm | 25 pieces |

TLC SPRAY KIT



➤ Offers an economical solution for TLC spraying. Provides a fine uniform spray ideally adjusted for TLC practices.

➤ Supplied complete with 100 ml erlenmeyer with sprayer head and a rubber pressure bellow.

| catalogue number | pack quantity |
|------------------|---------------|
| 108.02.002 | 1 piece |

TLC SPRAYER - "with gas canister"

➤ TLC sprayer provide a fine, uniform spray all over the TLC plate surfaces for optimization of TLC plates.

➤ With it's unique design offer easy-to-use and easy-to-clean options.

➤ Based on a simple technology where the aerosol canister is situated above the reservoir bottle.

➤ A small press of the lever highly pressurises the lower glass reservoir bottle releasing a fine mist of spray.

➤ Propellant mixture is eco-friendly and does not harms the nature.

➤ Guarantees homogenous distribution, even coverage and minimum reagent consumption.

➤ Gas canister serves as handle. Cap fits to all 38 - 40 thread reagent bottles.

| catalogue number | pack quantity |
|------------------|---------------|
| 108.02.001 | 1 piece |

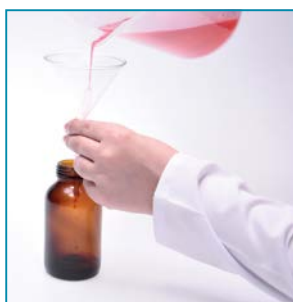

Filling: Pour the TLC reagent into the bottle. Never fill above the shoulder line.

Mounting: Attach TLC sprayer to the bottle by turning anti-clockwise. Never shake the sprayer during mounting.

Spraying: Start spraying with the sprayer and release the button while the sprayer is still moving at the end of the TLC plate to avoid reagent loss. For best performance a spraying angle between 90° and 45° is required.

Also always hold the sprayer at a distance between 15 cm to 30 cm from TLC plate surface.



*life sciences
microscopy
microbiology*

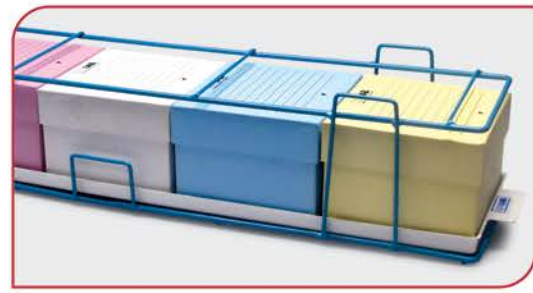



TUBES - "centrifuge" "conical bottom" - "screw cap"

- Manufactured from ultra clear, high grade polypropylene.
- Ultra rugged tube wall guarantees resistance to high centrifugal forces up to 6.000 RCF.
- Autoclavable at 121°C for 20 minutes. Caps should not be kept closed during autoclaving process.
 - **non-sterilized**
 - **Alternative 3 tubes:**
 - **aseptic tubes**
 - **sterile tubes**
- Aseptic tubes are manufactured in germ-free, class 10.000 sterile areas.
- Sterile tubes are manufactured in germ-free, class 10.000 sterile production areas and then re-sterilised by gamma irradiation.
- Sterile tubes are supplied with a certificate as a guarantee of "DNase, RNase & pyrogen free" product.
- Caps are manufactured from polyethylene with large ridges for increased grip for easy opening and closing.



Individually single packed sterile tubes have printed lot number, production date and expiry date on the package.



Sterile tubes are supplied with a certificate as a guarantee of "DNase, RNase & pyrogen free" criterias and guarantees the documentation of the quality.

- Cap inner design ensures hermetical and leak-proof closure. Caps can be opened and closed with single hand. A 3/4 turn of the cap will be sufficient for full closure.

- Graduations on side wall offer visual control of the filled volume. Printed marking area on side wall enables easy marking and labelling.

- Flat cap top provides multiple options for marking and labelling of the tube.

- Precise volume marks at the tube bottom clearly and visually show the liquid volume at the tube bottom.



Precise volume marks at the tube bottom clearly and visually show the liquid volume at the tube bottom.



Unique cap design with large ridges enables single hand operation. A 3/4 turn of the cap will be sufficient for hermetical and leak-proof closure of the tube.

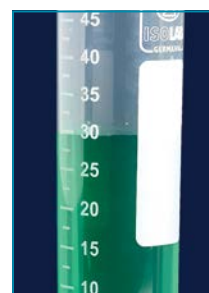

Printed marking area on side wall enables easy marking and labelling. Clear graduations for easy volume reference.

| clear tubes | amber tubes | volume | tube dimensions | product specifications | packing specifications | pack quantity | box quantity |
|-------------|-------------|--------|-----------------|-----------------------------------|------------------------|---------------|--------------|
| 078.02.001 | 078.12.001 | 15 ml | 17 x 120 mm | non sterilized | pack in bag | 50 pieces | 500 pieces |
| 078.02.003 | 078.12.003 | 50 ml | 30 x 120 mm | non sterilized | pack in bag | 50 pieces | 500 pieces |
| 078.02.007 | 078.12.007 | 15 ml | 17 x 120 mm | sterilized - aseptic | pack in bag | 50 pieces | 500 pieces |
| 078.02.008 | 078.12.008 | 50 ml | 30 x 120 mm | sterilized - aseptic | pack in bag | 50 pieces | 500 pieces |
| 078.02.002 | 078.12.002 | 15 ml | 17 x 120 mm | gamma sterilized - DNA & RNA free | single flow pack | 50 pieces | 500 pieces |
| 078.02.004 | 078.12.004 | 50 ml | 30 x 120 mm | gamma sterilized - DNA & RNA free | single flow pack | 50 pieces | 500 pieces |



TUBES - "centrifuge" "self standing" - "screw cap"

- Manufactured from ultra clear, high grade polypropylene. Self stands on the laboratory benches without the need of any tube support.
- Ultra rugged tube wall guarantees resistance to high centrifugal forces up to 6.000 RCF.
- Autoclavable at 121°C for 20 minutes. Caps should not be kept closed during autoclaving process.
- **Alternative 3 tubes:**
 - non-sterilized
 - aseptic tubes
 - sterile tubes
- Aseptic tubes are manufactured in germ-free, class 10.000 sterile areas.
- Sterile tubes are manufactured in germ-free, class 10.000 sterile production areas and then re-sterilised by gamma irradiation.
- Sterile tubes are supplied with a certificate as a guarantee of "DNase, RNase & pyrogen free" product.
- Caps are manufactured from polyethylene with large ridges for increased grip for easy opening and closing. Other technical specifications are exactly similar to the conical bottom.



| clear tubes | amber tubes | volume | tube dimensions | product specifications | packing specifications | pack quantity | box quantity |
|-------------|-------------|--------|-----------------|-----------------------------------|------------------------|---------------|--------------|
| 078.02.005 | 078.12.005 | 50 ml | 30 x 120 mm | non sterilized | pack in bag | 50 pieces | 500 pieces |
| 078.02.009 | 078.12.009 | 50 ml | 30 x 120 mm | sterilized - aseptic | pack in bag | 50 pieces | 500 pieces |
| 078.02.006 | 078.12.006 | 50 ml | 30 x 120 mm | gamma sterilized - DNA & RNA free | single flow pack | 50 pieces | 500 pieces |

TUBE RACKS - "for 15 & 50 ml conical bottom centrifuge tubes" - "push & hold"

- Manufactured from high grade polypropylene for safe holding and carrying conical bottom centrifuge tubes.
- Resistant to most acids, bases, and many commonly used solvents. Guarantees high temperature resistance between -20°C to +121°C.
- Uniquely designed to carry 25 tubes in 5 x 5 array tube compartments for holding the tubes in their position firmly.
- Very easy to use; Just press the tubes slightly into the tube compartments and leave.
- Different color options offer visual sorting and organising of different samples.
- Empty racks are easily stackable for reducing storage space.
- Alphanumerical index on tube rows enables easy identification of tube positions.

| catalogue number | for tubes | well quantity | tube array | L x W x H | pack quantity |
|------------------|-----------|---------------|------------|---------------|---------------|
| 078.06.015B | 15 ml | 25 | 5 x 5 | 120x150x32 mm | 1 piece |
| 078.06.050B | 50 ml | 25 | 5 x 5 | 190x230x35 mm | 1 piece |



Designed to carry 25 tubes in 5 x 5 array tube compartments.







Unique designed tube compartments hold the tube in their position firmly.

TUBE RACKS - "for 15 & 50 ml conical bottom centrifuge tubes" - "hedgehog design"



- Manufactured from "modified" high quality ABS which enables the rack to be used in water baths without the risk of floating.
- Resistant to most acids, bases, and many commonly used solvents.
- "Hedgehog" designed cross formed tube support rods enable uniform aligning of tubes in their position firmly.
- Unique rack design allows easy viewing of the tube contents in 4 angles.
- Different color options offer visual sorting and organising of different samples.
- The interlocking design of the racks makes them ideal for creating a user friendly workstation.
- These racks can also be used as drying rack for tubes and chromatography plates.

| catalogue number | for tubes | well quantity | tube array | L x W x H | rack color | pack quantity |
|------------------|-----------|---------------|------------|---------------|---|---------------|
| 079.08.015B | 15 ml | 50 | 5 x 10 | 140x270x66 mm | blue  | 1 piece |
| 079.08.015L | 15 ml | 50 | 5 x 10 | 140x270x66 mm | dark blue  | 1 piece |
| 079.08.050B | 50 ml | 25 | 5 x 5 | 200x200x70 mm | blue  | 1 piece |
| 079.08.050L | 50 ml | 25 | 5 x 5 | 200x200x70 mm | dark blue  | 1 piece |

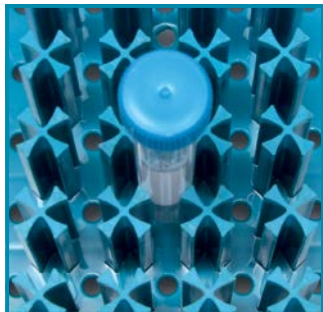

"Hedgehog" designed cross formed tube supports enable uniform aligning of tubes in positions firmly.

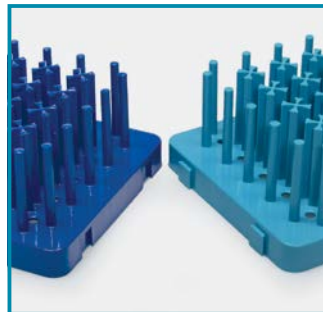

The interlocking design of the racks makes them ideal for creating a user friendly workstation.



Different color options offer visual sorting and organising of different samples.

TUBE BOX - "for 15 & 50 ml conical bottom centrifuge tubes" - "cardboard"



- Manufactured from freeze resistant, water repellent, durable cardboard covered with superior quality chromated paper coating.
- Press on lids perfectly fit to the box body provides a safe and tight closure. Protects the box interior from dust, moisture and other environmental effects.
- Special moisture repellent coating protects box interior from the effects of liquid nitrogen or condensation from refrigerators.
- Sized to fit all standard steel and polycarbonate freezer racks
- Chemically resistant to alcohols and mild organic solvents. Offers temperature resistance between -196°C to +121°C.
- Alphanumeric index on the lid for identification of tube positions.
- Write on area at the side wall and the lid provides a convenient area for special notes.

| catalogue number | for tubes | well quantity | tube array | L x W x H | pack quantity |
|------------------|-----------|---------------|------------|----------------|---------------|
| 078.20.015W | 15 ml | 36 | 6 x 6 | 130x130x125 mm | 1 piece |
| 078.20.050W | 50 ml | 16 | 4 x 4 | 150x150x125 mm | 1 piece |



TUBE RACKS - "foldable"

- Manufactured from modified polypropylene which enables the racks to be used in water baths without floating.
- Resistant to most acids, bases, and many commonly used solvents. Guarantees high temperature resistance between -20°C to +121°C.
- Raised tube sockets guarantee firm hold of the tubes at their exact positions.
- The alpha numeric grid reference on the top tier of the rack ensures an easy tube location and sample positioning.
- Racks are supplied assembled and folded. Can be ready for use in few seconds with a simple action.
- These racks can be refolded after use for reducing storage area.

| catalogue number | tube volume | tube quantity | tube array | pack quantity |
|------------------|-------------|---------------|------------|---------------|
| 079.03.003B | 15 ml | 50 | 5 x 10 | 1 piece |
| 079.03.005B | 50 ml | 26 | 4 x 6/7 | 1 piece |
| 079.03.006B | 15 & 50 ml | 21 & 12 | assorted | 1 piece |



Raised tube supports strongly hold the tubes in their position.

Tube rack can be folded for space saving solution.

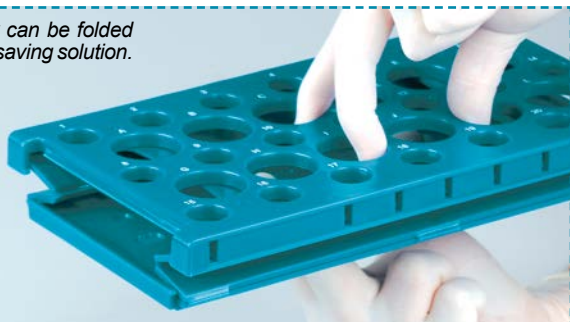

TUBE RACK - "snapable"

- Manufactured from high grade ABS for safe holding and carrying conical bottom centrifuge tubes.
- Uniquely designed to carry 30 x 15 ml and 20 x 50 ml centrifuge tubes simultaneously.
- Rack is supplied already disassembled. Unique and practical "snapping" system allows the rack "ready to use" in few seconds.
- Alphanumerical index on the lid enables easy identification of tube positions.

| catalogue number | tube volume | tube quantity | tube array | pack quantity |
|------------------|-------------|---------------|------------|---------------|
| 079.04.001 | 15 & 50 ml | 30 & 20 | assorted | 1 piece |

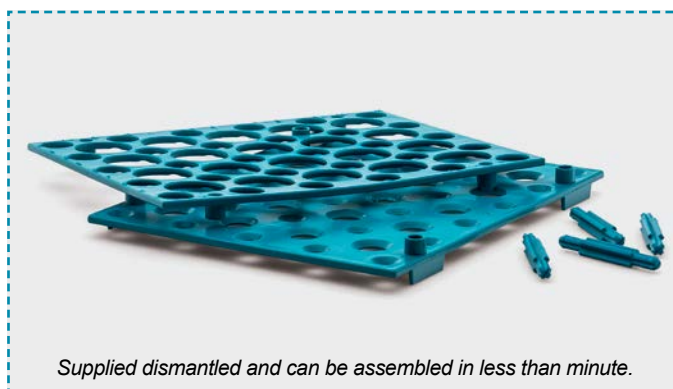

Supplied dismantled and can be assembled in less than minute.



Holes at the bottom plate guarantee firm hold of tubes in their position.



CENTRIFUGE TUBES - "micro" - "with flat cap"

➤ Manufactured from ultra clear polypropylene with flat caps that ensure smooth opening and closing with one hand. Once closed they guarantee leak-proof closure

➤ **Conical bottom tubes which need a tube rack**

➤ **Alternative 2 shapes:**

➤ **Skirted tubes which can self stand on benches.**

➤ Skirted tubes can self stand on laboratory benches without the need of any tube rack.

➤ Ultra rugged tube wall guarantees resistance to high centrifugal forces up to 20.000 RCF. Optimum tube design offers micro pestle compatibility.

➤ Reinforced tube bottom ensures added protection against deformation and leakage. Conical bottom form guarantees excellent fit to almost all centrifuge rotors. Highly polished interior wall guarantees low liquid retention and ensures minimum sample loss.

➤ Autoclavable at 121°C for 20 minutes. Caps should not be kept closed during autoclaving process. Otherwise tubes can be deformed.

➤ **Alternative 2 tubes:** ➤ **aseptic tubes**
➤ **gamma sterile tubes**

➤ Aseptic tubes are manufactured in germ-free, class 10.000 sterile production areas with extreme sterility control.

➤ Sterile tubes are manufactured in germ-free, class 10.000 sterile production areas and then resterilised by gamma irradiation. Supplied with a certificate as a guarantee of "DNase, RNase & pyrogen free" product.

➤ Improved cap design ensures smooth opening and closing with one hand. Inner design ensures hermetical and leak-proof closure. Cap can be pierced easily with any syringe needle.

➤ Graduations on the side wall offer visual control of the filled volume. Frosted marking area on side wall enables easy marking and labelling.

| tubes sterilized | tubes non sterilized | volume | skirt | pack quantity | box quantity |
|------------------|----------------------|--------|-------|---------------|--------------|
| 078.03.021 | 078.03.001 | 0.5 ml | non | 500 pieces | 5000 pieces |
| 078.03.022 | 078.03.002 | 1.5 ml | non | 500 pieces | 5000 pieces |
| 078.03.023 | 078.03.003 | 2.0 ml | non | 500 pieces | 5000 pieces |
| 078.03.024 | 078.03.004 | 2.0 ml | yes | 500 pieces | 5000 pieces |



CENTRIFUGE TUBES - "micro" - "with safe-lock cap"

➤ Manufactured from ultra clear polypropylene with safe lock caps that ensure smooth opening and closing with one hand.

➤ Once closed they guarantee leak-proof closure.

➤ Safe-lock caps have a small clasp that clips onto the rim of the tube preventing accidental openings specially during applications where heating is required.

➤ **Alternative 2 tubes:** ➤ **aseptic tubes**
➤ **gamma sterile tubes**

➤ All other technical specifications are identical with flat cap tubes.

| tubes sterilized | tubes non sterilized | volume | pack quantity | box quantity |
|------------------|----------------------|--------|---------------|--------------|
| 078.05.022 | 078.05.002 | 1.5 ml | 500 pieces | 5000 pieces |
| 078.05.025 | 078.05.005 | 5.0 ml | 200 pieces | 2000 pieces |

TUBE ADAPTER - "for 5 ml microtubes"



➤ Manufactured from polypropylene.

➤ Perfectly fits to the bottom part of the 15 ml centrifuge tube rotors.

➤ They provide the practical usage of the 5 ml tube in a 15 ml rotor.

| catalogue number | pack quantity |
|------------------|---------------|
| 078.05.105 | 8 pieces |

CRYO TUBES - "sterile"

- Designed for the storage and conservation of biological material, human and animal cells at very low temperatures in the gas phase of liquid nitrogen or in cryogenic freezers.
- Manufactured from ultra clear, polypropylene by fully automatic machines. Highly polished interior wall guarantees low liquid retention and ensures minimum sample loss.
- Cryo tubes are manufactured in germ-free, class 10.000 sterile production areas and then resterilised by gamma irradiation.
- Tubes are supplied with a certificate as a guarantee of "DNase, RNase & pyrogen free" product.
- Since both cap and tube are made of same material with same coefficient of expansion secure seal at all temperatures.
- Caps are featured with cavities for different colored cap inserts which enable easy identification of tube contents. Cap inner design ensures hermetical and leak-proof closure
- The external thread of the tube ensures secure and tight closure and prevents leakage without silicone gasket.
- Caps can be opened and closed with single hand. A 3/4 turn of the cap will be sufficient for full closure.
- Unique foot design enables free standing option. Foot design allows the tube to be fixed at the cryo vial racks. Tube caps can be opened by single hand.

| cryo tubes with external thread | tube volume | tube height (mm) | tube diameter (mm) | pack quantity |
|---------------------------------|-------------|------------------|--------------------|---------------|
| 091.11.102 | 2.0 ml | 48,00 ± 1,00 | 11,90 ± 0,1 | 100 pieces |
| 091.11.105 | 5.0 ml | 88,00 ± 1,00 | 11,90 ± 0,1 | 100 pieces |



Unique star-base foot design enables free standing option.

Base design allows the tube to be fixed at the cryo vial racks. Tube caps can be opened by single hand without the need of picking up the tubes.



The external thread of the tube ensures secure and tight closure and prevents leakage without silicone gasket.



Graduations on the side wall offer visual control of the filled volume.

CRYO TUBE CANES - "polycarbonate"



➤ Made from polycarbonate for holding cryo tubes. Ideal tool to insert the cryo tubes into cryo freezer storage or into dewar flasks. With their total length of 310 mm they can carry 6 pieces 2,0 ml and 3 pieces 5,0 ml cryo tubes at a row.

| catalogue number | pack quantity |
|------------------|---------------|
| 092.35.003 | 12 pieces |

CAP INSERTS

- Caps are featured with cavities for different colored cap inserts. Cap inserts are made from P.P with different colors for easy identification of tubes.
- They fit precisely into the caps by slight pressing. They can be easily dismantled.

| catalogue number | cap inserts disc color | pack quantity |
|------------------|------------------------|---------------|
| 091.15.001 | white | 100 pieces |
| 091.15.002 | blue | 100 pieces |
| 091.15.003 | yellow | 100 pieces |
| 091.15.004 | red | 100 pieces |
| 091.15.005 | green | 100 pieces |



MICROTUBE RACKS "foldable"

➤ Manufactured from polypropylene with high mechanical strength.

➤ Resistant to most acids, bases and solvents. Guarantees high temperature resistance between -20°C to +121°C.

➤ Alphanumerical index on tube rows enables easy identification of tube positions. Marking areas on wall sides enable easy marking and labelling.

➤ Supplied dismantled as a sheet and can easily be assembled in few seconds.

➤ Also can be dismantled in few seconds and forms a flat layer for safe and efficient storage purpose.

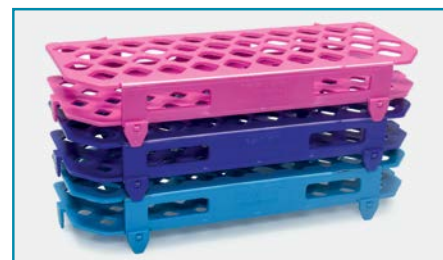

Different color options offer visual sorting and organising of different samples. After replacement of the tubes racks can be stacked on top of each other for space saving.



Supplied dismantled as a sheet and can easily be assembled in few seconds.

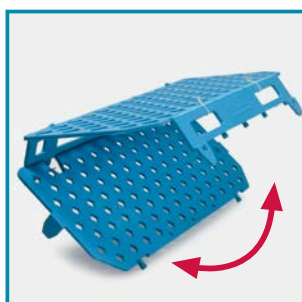

Also can be dismantled in few seconds and forms a flat layer for safe and efficient storage purpose.

| racks for 1,5 & 2,0 ml | well quantity | racks for 5,0 ml | well quantity | rack L x W x H | rack color | pack quantity |
|------------------------|---------------|------------------|---------------|----------------|------------|---------------|
| 080.01.005B | 100 | 080.01.006B | 42 | 110x260x45 mm | blue | 1 piece |
| 080.01.005P | 100 | 080.01.006P | 42 | 110x260x45 mm | purple | 1 piece |
| 080.01.005R | 100 | 080.01.006R | 42 | 110x260x45 mm | ruby | 1 piece |

MICROTUBE RACKS "monoblock"

➤ Manufactured from polypropylene with high mechanical strength.

➤ Resistant to most acids, bases and solvents. Guarantees high temperature resistance between -20°C to +121°C.

➤ Can be used with a unique base support tray that provides alternative inclined position for the rack.

➤ According to the wish rack can be used horizontally or with 30 degree angle providing easy filling option of the tubes.

➤ After replacement of the tubes racks can be stacked on top of each other for space saving solution.

➤ Alphanumerical index on tube rows enables easy identification of tube positions.

➤ Marking areas on wall sides enable easy marking and labelling.



| catalogue number | for tubes | well quantity | tube array | rack L x W x H | rack color | pack quantity |
|------------------|--------------|---------------|------------|----------------|------------|---------------|
| 080.01.004B | 1,5 / 2,0 ml | 96 | 8 x 12 | 205x135x55 mm | blue | 1 piece |
| 080.01.004P | 1,5 / 2,0 ml | 96 | 8 x 12 | 205x135x55 mm | purple | 1 piece |
| 080.01.004R | 1,5 / 2,0 ml | 96 | 8 x 12 | 205x135x55 mm | ruby | 1 piece |
| 080.01.007B | 5,0 ml | 48 | 6 x 8 | 205x135x70 mm | blue | 1 piece |
| 080.01.007P | 5,0 ml | 48 | 6 x 8 | 205x135x70 mm | purple | 1 piece |
| 080.01.007R | 5,0 ml | 48 | 6 x 8 | 205x135x70 mm | ruby | 1 piece |

BASE SUPPORT

➤ Base support is manufactured from acrylic with 30° inclination. When placed under the tube rack with the help of 30 degree inclination this support offers easy filling options of the tubes specially when you are sitting.

| catalogue number | color | pack quantity |
|------------------|-------|---------------|
| 080.01.101 | white | 1 piece |







MICROTUBE RACKS

"3 tier"

- Manufactured from polypropylene with high mechanical strength.
- Resistant to most acids, bases and solvents. Guarantees high temperature resistance between -20°C to $+121^{\circ}\text{C}$.
- The interlocking design of the racks makes them ideal for creating a workstation.
- Raised tube slots guarantee firm and stable hold of tubes in vertical position.
- Alphanumerical index on tube rows enables easy identification of tube positions. Marking areas on wall sides enable easy marking and labelling.

➤ Unique design for to carry 3 different size micro tubes on each tier:

- Bottom row carries 24 x 0,2 ml (2 x 12 array) micro tubes.
- Middle row carries 14 x 0,5 ml (2 x 7 array) micro tubes.
- Upper row carries 12 x 1,5 ml (2 x 6 array) micro tubes.

| catalogue number | rack dimensions | rack color | pack quantity |
|------------------|-----------------|--|---------------|
| 080.01.003B | 165x125x60 mm | blue  | 1 piece |
| 080.01.003P | 165x125x60 mm | purple  | 1 piece |
| 080.01.003R | 165x125x60 mm | ruby  | 1 piece |

Different color options offer visual sorting and organising of different samples



MICROTUBE RACKS



"double side"

- Manufactured from polypropylene with high mechanical strength.
- Resistant to most acids, bases and solvents. Guarantees high temperature resistance between -20°C to $+121^{\circ}\text{C}$.
- Rack has two sides and each side accommodates different size and combination of microcentrifuge tubes.
- Clear box lid enables easy identification of rack content and protects the tubes from dust, moisture and other effects.
- Alphanumerical index on tube rows enables easy identification of tube positions. Marking areas on wall sides enable easy marking and labelling.
- Different color options offer visual sorting and organising of different samples.
- Racks can be stacked on top of each other for space saving.
- Uniquely designed to carry different size micro tubes on both sides.

➤ **Upper side:** carries 96 x 1,5 ml (6x16 array) micro tubes

➤ **Reverse side:** carries 48x0,5 ml (6x8 array) and 96 x 0,2 ml (8x12 array) micro tubes.



| catalogue number | dimensions | rack color | pack quantity |
|------------------|---------------|--|---------------|
| 080.06.002B | 290x110x60 mm | blue  | 1 piece |
| 080.06.002P | 290x110x60 mm | purple  | 1 piece |
| 080.06.002R | 290x110x60 mm | ruby  | 1 piece |

Racks can be stacked on top of each other for space saving.

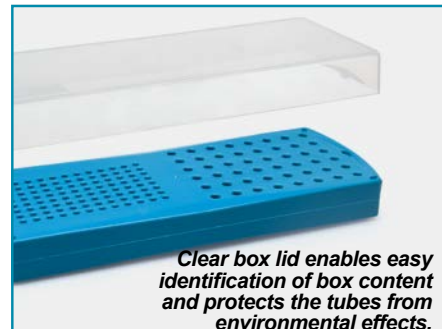

CRYO TUBE WORK STATION - "50 well"

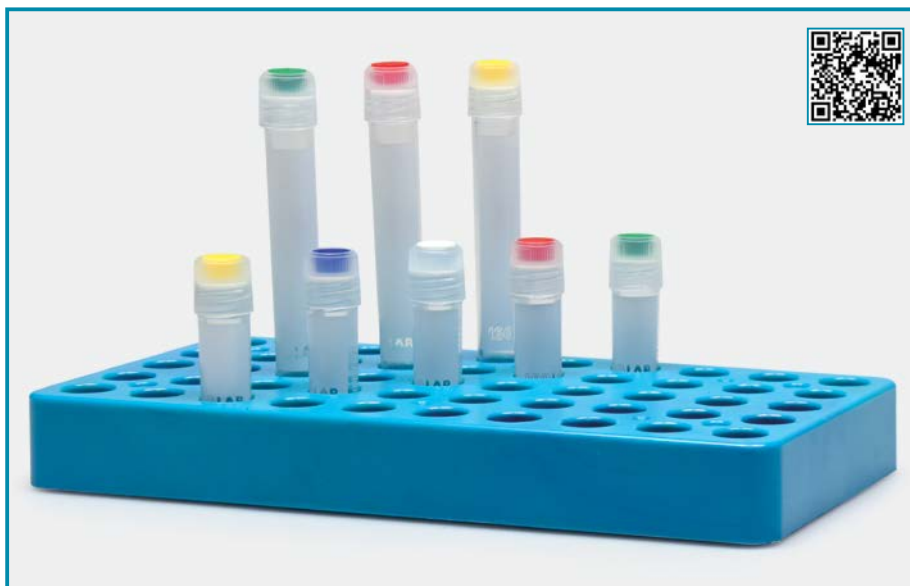

➤ Manufactured from polycarbonate with high mechanical strength.

➤ Resistant to most acids, bases and solvents. Guarantees high temperature resistance between -196°C to +121°C.

➤ Uniquely designed to carry 50 pieces of 2,0 ml & 5,0 ml volume cryo tubes in 10 x 5 array.

➤ These racks allow easy one handed opening and closing of tubes thanks to an innovative locking system.

➤ The locking system at the well bottoms ensures that tubes will securely lock in each position and will not return in their axis.

➤ Alphanumerical index on tube rows enables easy identification of tube positions.

➤ Featured with a frosted write on and labelling area at the front side.

➤ Different color options offer visual sorting and organising of different samples

| catalogue number | for tubes | well quantity | tube array | L x W x H | rack color | pack quantity |
|------------------|--------------|---------------|------------|---------------|------------|---------------|
| 092.01.001B | 2,0 - 5,0 ml | 50 | 10 x 5 | 195x101x24 mm | blue | 1 piece |
| 092.01.001P | 2,0 - 5,0 ml | 50 | 10 x 5 | 195x101x24 mm | purple | 1 piece |
| 092.01.001R | 2,0 - 5,0 ml | 50 | 10 x 5 | 195x101x24 mm | ruby | 1 piece |

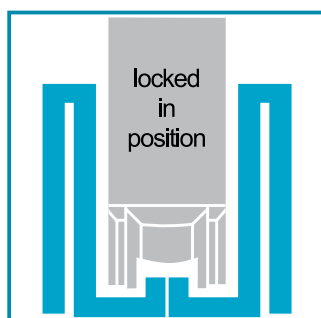

These racks allow easy one handed opening and closing of tubes thanks to an innovative locking system.

The locking system at the well bottoms ensures that tubes will securely lock in each position and will not return in their axis.

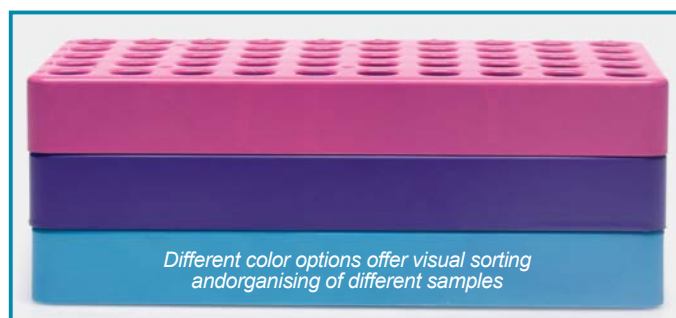

Different color options offer visual sorting and organising of different samples

TUBE BOX - "100 well" - "hinged lid"



➤ Manufactured from polypropylene with high mechanical strength. Resistant to most acids, bases and solvents. Guarantees high temperature resistance between -20°C to +121°C.

➤ Uniquely designed to carry 100 cryo tubes in 10 x 10 array.

➤ Hinged lid with built-in stop allows easy one-handed access. Featured with a frosted write on area at the front side of the lid.

➤ Clear box lid enables easy identification of box content and protects the tubes from environmental effects.

➤ Moulded frames at the corners of the tube boxes enable perfect stacking on top each other without sliding.



Alphanumerical index both on tube rows and the lid enables easy identification of tube positions.



Different color options offer visual sorting and organising of different samples.

| catalogue number | tube array | L x W x H (mm) | rack color | pack quantity |
|------------------|------------|----------------|------------|---------------|
| 080.01.002B | 10 x 10 | 141x151x53 | blue | 1 piece |
| 080.01.002P | 10 x 10 | 141x151x53 | purple | 1 piece |
| 080.01.002R | 10 x 10 | 141x151x53 | ruby | 1 piece |

CRYO TUBE BOXES - "81 well" - "polycarbonate"

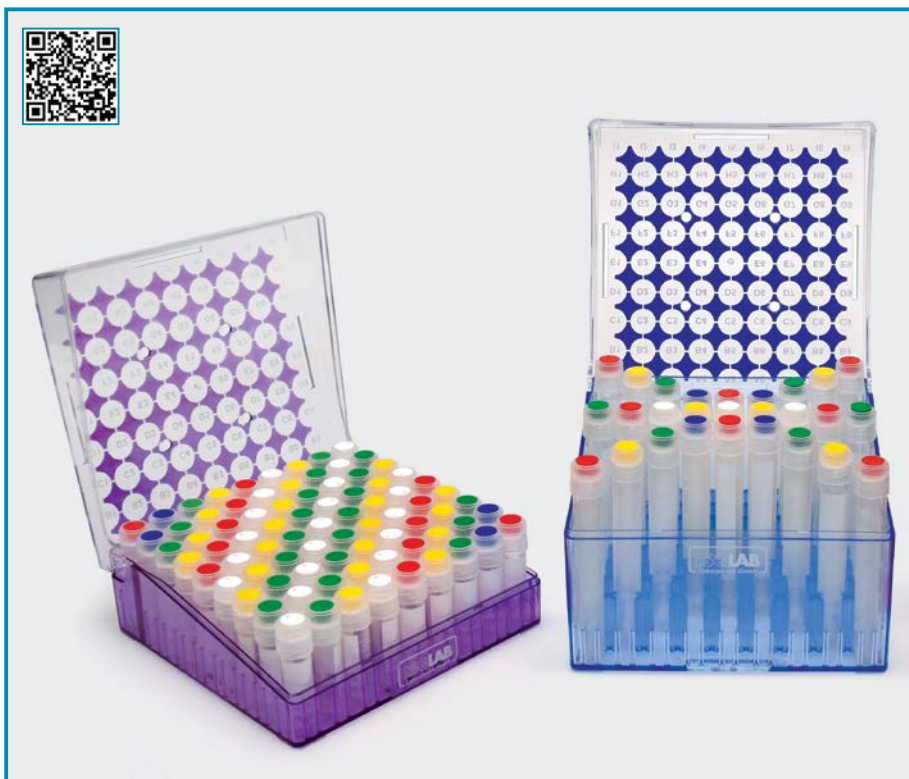

➤ Manufactured from polycarbonate with high mechanical strength and high temperature resistance between -196°C to $+121^{\circ}\text{C}$.

➤ Uniquely designed to carry 81 pieces micro or cryo tubes in 9 x 9 array.

➤ "Hedgehog" designed tube compartments hold the tube in their position firmly. They fit all steel and polycarbonate freezer racks.

➤ Unique design with vent and drainage holes guarantees best, efficient air circulation.

➤ Forward slope base ensures quick visual orientation. Easily stackable for reducing storage space.

➤ Hinged lid with built-in stop allows very easy access to tubes.

➤ Clear box lid enables easy identification of box content and protects the tubes from dust, moisture and other environmental effects.

➤ Vent and drainage holes at the lid and the base guarantee the best air circulation.

➤ Alphanumeric index both on tube rows and the lid enables easy identification of tube positions.

➤ Featured with a frosted write on area at the front side of the lid.

➤ Different color options offer visual sorting and organising of different samples.

| catalogue number | for tubes | well quantity | tube array | L x W x H | box color | pack quantity |
|------------------|-----------|---------------|------------|---------------|-----------|---------------|
| 093.01.001G | 2,0 ml | 81 | 9 x 9 | 133x133x53 mm | green | 1 piece |
| 093.01.001P | 2,0 ml | 81 | 9 x 9 | 133x133x53 mm | purple | 1 piece |
| 093.01.001R | 2,0 ml | 81 | 9 x 9 | 133x133x53 mm | ruby | 1 piece |
| 093.01.002B | 5,0 ml | 81 | 9 x 9 | 133x133x96 mm | blue | 1 piece |

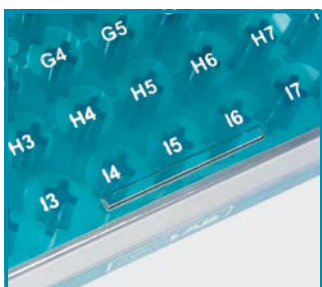

Vent and drainage holes at the lid and the base guarantee the best air circulation.



"Hedgehog" designed cross formed tube supports enable uniform aligning of tubes in positions firmly.

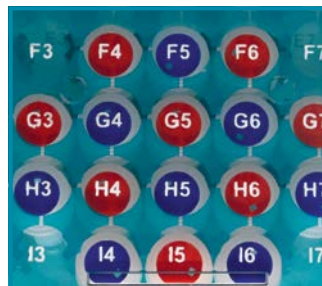

Alphanumeric index both on tube rows and the lid enables easy identification of tube positions.



Box is supplied together with a disposable forceps for easy removal of tubes.



CRYO TUBE BOXES - "81 well" - "cardboard"

➤ Manufactured from freeze resistant, water repellent, durable cardboard covered with superior quality chromated paper coating.

➤ Special moisture repellent coating protects box interior from the effects of liquid nitrogen or condensation from refrigerators.

➤ Chemically resistant to alcohols and mild organic solvents. Offers temperature resistance between -196°C to $+121^{\circ}\text{C}$.

➤ Alphanumeric index on the lid for identification of tube positions. Write on area at the side wall and the lid provides a convenient area for special notes.

➤ Press on lids perfectly fit to the box body provides a safe and tight closure. Protects the box interior from dust, moisture and other environmental effects.

➤ Sized to fit all standard steel and polycarbonate freezer racks

| catalogue number | for tubes | well quantity | tube array | L x W x H | pack quantity |
|------------------|-----------|---------------|------------|---------------|---------------|
| 092.22.101W | 2,0 ml | 81 | 9 x 9 | 135x135x50 mm | 1 piece |
| 092.22.102W | 5,0 ml | 81 | 9 x 9 | 135x135x95 mm | 1 piece |



PCR TUBES - "single cavity"

- Single cavity 0.2 ml PCR tubes for thermal transfer and PCR applications are manufactured from ultra clear, virgin polypropylene by fully automatic, human touch free machines.
- Manufactured in class 10.000 sterile areas as "DNase, RNase & pyrogen free" product.
- Uniform and thin wall design accelerates the thermal heat transfer and shortens the PCR reaction and cycling times.
- Optimum tube dimensions guarantee compatibility with most leading thermal cyclers.
- Cap inner design ensures hermetical and leak-proof closure
- Once cap is closed the tubes guarantee perfect sealing during thermal cycling preventing evaporation.
- Cap can be opened and closed with one hand without the risk of sample contamination.
- Group packed with lot number, production date and expiry date printed on the package.

| catalogue number | pack quantity | box quantity |
|------------------|---------------|---------------------|
| 123.01.002 | 500 pieces | 6 packs/3000 pieces |



PCR TUBES - "8 strip"

- 8 strip PCR tubes for thermal transfer and PCR applications are manufactured from ultra clear, high grade polypropylene by fully automatic, human touch free machines.
- They perfectly fit to all PCR plates and provide fast filling option by 8 channel pipettors.
- Manufactured in class 10.000 sterile areas as "DNase, RNase & pyrogen free" product.
- Uniform and thin wall design accelerates the thermal heat transfer and shortens the PCR reaction and cycling times.
- Unique design offers compatibility with most leading PCR thermal cyclers.
- Once caps are closed the tubes guarantee perfect sealing during thermal cycling preventing evaporation. Caps can be opened and closed with one hand without the risk of sample contamination.
- Group packed with lot number, production date and expiry date printed on the package.



| catalogue number | volume | product descriptions | pack quantity | box quantity |
|------------------|--------|--|---------------|-----------------------|
| 123.01.028 | 0,2 ml | clear PCR strips with attached flat caps | 12 pieces | 10 packs / 120 pieces |
| 123.03.028 | 0,2 ml | clear PCR strips with separate flat caps | 12 pieces | 10 packs / 120 pieces |

qPCR TUBES - "8 strip" - "with flat cap"

- 8 strip 0,1 ml qPCR tubes for thermal transfer and qPCR applications are manufactured from ultra clear, high grade polypropylene by fully automatic, human touch free machines. Manufactured in class 10.000 sterile areas as "DNase, RNase & pyrogen free" product.
- Uniform and thin wall design accelerates the thermal heat transfer and shortens the PCR reaction and cycling times. Low profile tube design offers compatibility with most leading qPCR machines.
- Once caps are closed the tubes guarantee perfect sealing during thermal cycling preventing evaporation. Caps can be opened and closed with one hand .



- Group packed with lot number, production date and expiry date printed on the package.

| catalogue number | volume | product descriptions | pack quantity | box quantity |
|------------------|--------|--|---------------|-----------------------|
| 123.02.028 | 0,1 ml | clear qPCR strips with seperated flat caps | 12 pieces | 10 packs / 120 pieces |
| 123.02.018 | 0,2 ml | clear qPCR strips with seperated flat caps | 12 pieces | 10 packs / 120 pieces |

PCR PLATES

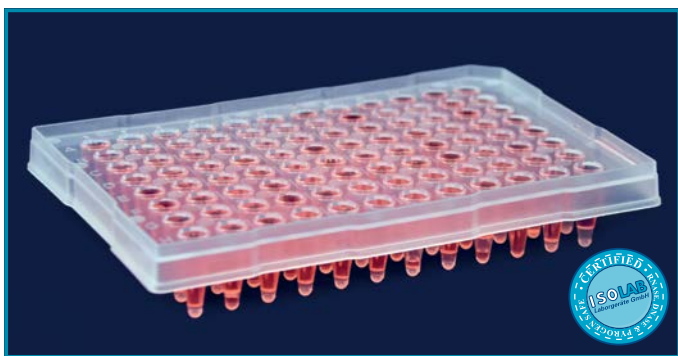
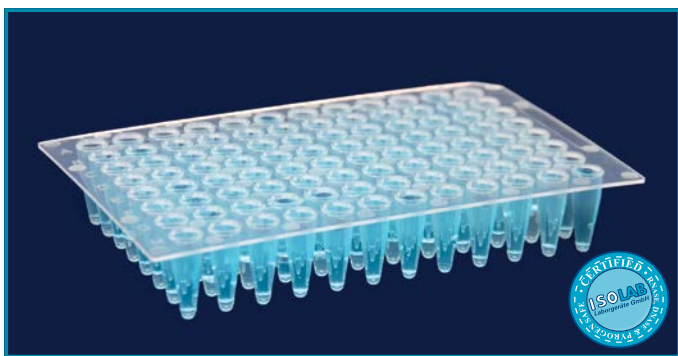

- 96 well PCR plates with 0,2 ml wells for thermal transfer and PCR applications are manufactured from ultra clear, virgin polypropylene by fully automatic, human touch free machines.
- Manufactured in class 10.000 sterile areas as “DNase, RNase & pyrogen free” product.
- Uniform and thin wall design accelerates the thermal heat transfer and shortens the reaction and cycling times.
- Unique design offers compatibility with most leading PCR machines
- Alphanumerical index on tube rows enables easy identification of tube positions.
- Single packed with lot number, production date and expiry date printed on the package.

| catalogue number | product descriptions | pack quantity | box quantity |
|------------------|----------------------|---------------|---------------------|
| 123.01.096 | Non- skirted | 10 pieces | 5 packs / 50 pieces |
| 123.02.096 | Semi skirted | 10 pieces | 5 packs / 50 pieces |

SEALING FILMS - “for PCR and qPCR plates”

- Manufactured from polyester based film with acrylic adhesive back. “DNase, RNase & pyrogen free” product.
- Guarantees excellent chemical and temperature resistance between -40°C to +120°C.
- Can be used with all kinds of microplates including raised rim and skirted ones. Transparency allows optical analysis possibility of PCR and qPCR applications.
- Allows easier and more accurate positioning and more secure sealing around each well.
- Prevents cross contamination between samples and wells.
- Also does not interfere with cycle reactions and does not cause spills on PCR samples.



| catalogue number | product descriptions | pack quantity | box quantity |
|------------------|--------------------------|---------------|--------------|
| 124.01.001 | Membranes for PCR plates | 10 pieces | 100 pieces |

PCR RACK & WORK STATION

- Manufactured from polypropylene for “before” and “after” use at PCR sampling and applications.
- Rack can carry 3 different size PCR tubes & PCR strips.
 - 96 x 0,2 ml PCR tubes (8x12 array)
 - 12 x strip of 8 PCR tubes (8x12 array)
 - 8 x strip of 12 PCR tubes (8x12 array)
- Alphanumerical index on tube rows enables easy identification of tube positions.

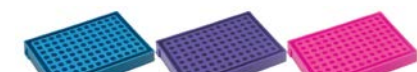

| blue rack | purple rack | ruby rack | rack (mm) dimensions | pack quantity |
|-------------|-------------|-------------|----------------------|---------------|
| 089.03.012B | 089.03.012P | 089.03.012R | 125x88x31 | 1 piece |

- Rack can carry 3 different size tubes
 - 32 x 0,2 ml PCR tubes (4x8 array)
 - 16 x 0,5 ml PCR tubes (2x8 array)
 - 24 x 1,5 ml micro tubes (4x6 array)

| catalogue number | rack dimensions | pack quantity |
|------------------|-------------------|---------------|
| 089.03.013 | 210 x 115 x 50 mm | 1 piece |

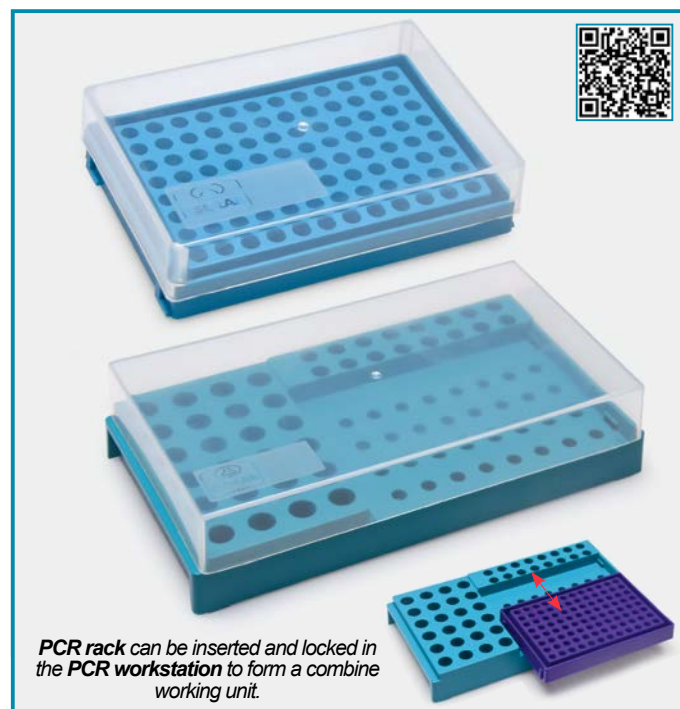



FLASKS - "for cell culture"

- Manufactured from optically clear polystyrene in germ-free, class 10.000 sterile production areas and then resterilised by gamma irradiation. Supplied with a certificate as a guarantee of "DNase, RNase & pyrogen free" product.
- Offers absolutely flat growth surface with surface activated growth area for fast and efficient growth.
- Special design offers minimized contamination risk. Angled design of the flask neck allows easy access to each corner with 100 % cell retrieval without leaving any dead corners.
- Caps are made from polypropylene with large ridges with increased grip. Cap inner design ensures hermetical and leak-proof closure.
- Caps can be opened and closed with single hand. A 2/3 turn of the cap will be sufficient for hermetic and leak-proof closure.
- Graduations on the side wall offer visual control of the filled volume. Marking area on side wall enables easy marking and labelling.
- Individually single packed with lot number, production date and expiry date printed on the package.

| catalogue number | growth area | working volume | cap type | surface treatment | pack quantity | box quantity |
|------------------|---------------------|----------------|----------------------|-------------------|---------------|--------------|
| 120.11.025 | 25 cm ² | 7 ml | vent cap with filter | yes | 5 pieces | 200 pieces |
| 120.11.075 | 75 cm ² | 25 ml | vent cap with filter | yes | 5 pieces | 100 pieces |
| 120.11.175 | 182 cm ² | 50 ml | vent cap with filter | yes | 5 pieces | 40 pieces |
| 120.12.025 | 25 cm ² | 7 ml | plug seal cap | yes | 5 pieces | 200 pieces |
| 120.12.075 | 75 cm ² | 25 ml | plug seal cap | yes | 5 pieces | 100 pieces |
| 120.12.175 | 182 cm ² | 50 ml | plug seal cap | yes | 5 pieces | 40 pieces |

"plug cap for airtight culture"



Plug seal cap usually used for airtight culture applications. Can be used also for open culture when the cap is unscrewed.

"plug cap for airtight culture"



Vent cap is designed for open culture applications. Includes a contamination preventing hydrophobic membrane 0,2 µm.



Angled design of the flask neck allows easy access to each corner with 100 % cell retrieval without leaving any dead corners.



Ergonomic design minimizes contamination and raised corners at the body enables easy and slip-free stacking possibility.

CENTRIFUGE TUBES - "for cell culture"

- Manufactured from **FDA approved** ultra clear, high grade polypropylene. Can resist centrifugation up to 6.000 RCF.
- Sterilized with gamma irradiation, **free of RNase, DNase, and pyrogene**.
- Individual packing eliminates the possible risks of contaminations.
- Their conical bottoms make them suitable for centrifugation tests in immunology, microbiology etc.

Other technical specifications can be seen at catalogue page no 180 - 181.





MULTIWELL PLATES - "for cell culture"

- Widely used plates for handling multiple samples in a single experiment during culture. Manufactured from optically clear polystyrene in germ-free, class 10.000 sterile production areas and then resterilized by gamma irradiation. Supplied with a certificate as a guarantee of "DNase, RNase & pyrogen free" product.
- Offers absolutely flat growth surface with surface activated growth area for fast and efficient growth. Unique design guarantees minimized cross contamination risk. They offer also easy handling with slip-free stacking possibility. Lid with air-venting system for controlled gas exchange with low evaporation.
- Vented base guarantees excellent air flow between stacked dishes to prevent condensation. Sloped edge allows placement of the lid in one single position. Uniform well volumes always ensures equal growth surface area.
- Individually single packed with lot number, production date and expiry date printed on the package.



Ergonomic design offers minimized contamination risk and easy handling with slip-free stacking possibility.

| catalogue number | well quantity | well type | external dimensions (mm) | well dimension | growth area | working volume | surface treatment | pack quantity | box quantity |
|------------------|---------------|-----------|--------------------------|----------------|----------------------|----------------|-------------------|---------------|--------------|
| 122.11.006 | 6 | flat | 85.4 x 127.6 x 22.5 | 35.0 x 17.5 mm | 9.60 cm ² | 3 ml | yes | 1 piece | 100 pieces |
| 122.11.012 | 12 | flat | 85.4 x 127.6 x 22.5 | 22.1 x 17.5 mm | 3.85 cm ² | 2 ml | yes | 1 piece | 100 pieces |
| 122.11.024 | 24 | flat | 85.4 x 127.6 x 22.5 | 15.5 x 17.5 mm | 1.93 cm ² | 1 ml | yes | 1 piece | 100 pieces |
| 122.11.048 | 48 | flat | 85.4 x 127.6 x 22.5 | 9.75 x 17.5 mm | 0.84 cm ² | 0,5 ml | yes | 1 piece | 100 pieces |
| 122.11.096 | 96 | flat | 85.4 x 127.6 x 16.0 | 6.50 x 10.8 mm | 0.33 cm ² | 0.2 ml | yes | 1 piece | 100 pieces |
| 122.11.196 | 96 | round | 85.4 x 127.6 x 16.0 | 6.92 x 12.0 mm | 0.58 cm ² | 0,2 ml | yes | 1 piece | 100 pieces |

PETRI DISHES - "for cell culture" - "sterile"

- Manufactured from optically clear, transparent polystyrene specially for cell culture practices.
- Manufactured in germ-free, class 10.000 sterile production areas and then resterilized by gamma irradiation.
- Supplied with a certificate as a guarantee of "DNase, RNase & pyrogen free" product.
- Stacking ring on the lid and the corresponding base part guarantees secure stacking option.
- Surface treated uniform flat growth surface guarantees excellent suspension for cultures.



| catalogue number | diameter | height | growth area | working volume | surface treatment | external grip | pack quantity | box quantity |
|------------------|----------|--------|----------------------|----------------|-------------------|---------------|---------------|--------------|
| 120.13.035 | 32.8 mm | 13 mm | 8.5 cm ² | 3 ml | yes | yes | 10 pieces | 960 pieces |
| 120.13.060 | 52.0 mm | 17 mm | 21.2 cm ² | 5 ml | yes | yes | 10 pieces | 600 pieces |
| 120.13.090 | 84.6 mm | 17 mm | 55.0 cm ² | 12.5 ml | yes | yes | 10 pieces | 500 pieces |



MAGNIFIER - "table top"

- Multifunctional table-top magnifier offers magnification power of 3X and 5X depending on view direction.
- Can be operated by one hand. Offers smooth and easy use with distant and near vision lenses.
- 4 LED bulbs with on/off control provide super bright powerful illumination.
- Two separate flexible gooseneck holders enable magnifying lens and illumination angle adjustable in multiangular axes.
- Shadow and flicker free illumination without heat development provides optimal concentration of light.
- Aspherical lens provides spherical aberration and distortion free images with edge-to-edge sharpness.
- Removable main body can be fixed at table corner with a clamp.
- Sturdy base plate increases the standing efficiency.
- The clamp mechanism at the base enables fixation of objects firmly in place.

| catalogue number | pack quantity |
|------------------|---------------|
| 065.10.001 | 1 piece |



MAGNIFIER - "handy type"

- Hand magnifier offers magnification power of 3X and 5X depending on view direction.
- Handle perfectly fits to hand with a comfortable grip.
- Aspherical lens provides spherical aberration and distortion free images with edge-to-edge sharpness.
- LED bulb with on/off control provides super bright powerful illumination.
- A rotatable joystick switch enables adjustment of illumination angle in all angles.

| catalogue number | external dimensions | lens dimensions | pack quantity |
|------------------|---------------------|-----------------|---------------|
| 065.10.006 | 230 x 100 mm | 100 mm | 1 piece |



MAGNIFIER - "pocket type"

- Perfect magnifier for reading small prints with magnification power of 2X.
- 3 LED bulbs with on/off control provides super bright powerful illumination.
- Ergonomic design enables intuitive movement on the reading material. Delivered in a soft protective bag

| catalogue number | external dimensions | lens dimensions | pack quantity |
|------------------|---------------------|-----------------|---------------|
| 065.10.004 | 60 x 145 mm | 60 x 100 mm | 1 piece |



REFRACTOMETER - "digital"

- With a wide measuring range offers a precise measurement and determination of refractive index and Brix values of liquid samples.
- Portable, light weight, compact design guarantees fast and easy measurements also eliminates the reading errors.
- Operation is extremely simple: only with a few drops of sample guarantees fast and reliable measurements.
- Zero point check and calibration can be done with water.
- LED light source around the prism warns the user during the calibration or measurement process.
- Simple and easy to change measuring from % Brix to refractive index. Features with automatic temperature compensation (ATC).

| catalogue number | measuring range % Brix | measuring range refractive index | division Brix / RI | ATC |
|------------------|------------------------|----------------------------------|--------------------|-----|
| 618.32.001 | 0 - 95 | 1,3330 - 1,5400 | 0,1/0,0001 | yes |



- Ideal for precise measurement and determination of refractive index and % Brix values of liquid, solid, semi-solid and powder samples. Simple handling and easy to use. Calibration can be done easily with supplied calibration prism.



REFRACTOMETER - "hand type"

- A practical alternative for practical yet quick measurement of concentrations of liquids.
- Portable and hand-held design enables both laboratory and field applications.
- Models with automatic temperature compensation are specially suitable for field use.
- With focusing eyepiece with soft rubber eyecups for reducing straylight ingress and also avoiding scratches at spectacle lenses.
- Calibration is easily done by turning the adjustment screw.

| catalogue number | measuring range % Brix | division % | ATC |
|------------------|------------------------|------------|-----|
| 618.21.001 | 0 - 10 | 0,1 | yes |
| 618.22.001 | 0 - 18 | 0,1 | yes |
| 618.23.001 | 0 - 32 | 0,2 | yes |
| 618.24.001 | 0 - 80 | 0,5 | no |
| 618.25.001 | 0 - 90 | 0,5 | no |

REFRACTOMETER - "ABBE"

- Large optical prism enables excellent boundary line brightness and contrast during measurements.
- Adjustable wide field eyepiece with 10X magnification, enables bright and clear images. Super contrast, optical system with 30X magnification guarantees sharp images.
- Equipped with movable, hinged covers to keep light out. Offers connection possibility to a thermostatic circulator.
- Featured with a digital thermometer with a large LCD display. Temperature reading is selectable as °C or °F with a precision of 0,1°C or 0,1°F.

| | |
|-----------------------------|--------------------------|
| catalogue number | 618.41.001 |
| external dimensions (mm) | 270 x 180 x 370 |
| refractive index (nD) | 1,3000 - 1,7000 |
| dissolved solid Brix (%) | 0 - 95 |
| accuracy | ± 0,0002 |
| water inlet / outlet Ø (mm) | 10 |
| digital thermometer | LCD display - 34 x 14 mm |
| temperature range (°C) | 0 - 70 |
| temperature uniformity (°C) | ± 0,1 |

MICROSCOPE - "biological"



- Ideal for academic and clinical research with excellent optical system, outstanding resolution and definition.
- Unique design with backward nosepiece offers larger working space and enables convenient handling.
- Featured with a 360° rotatable binocular head inclined at 30° with interpupillary distance adjustable 50 mm - 75 mm.
- Wide field eyepiece with 10X magnification power, 20mm lens diameter enables bright and clear images
- 4X, 10X, 40X and 100X plan achromatic objectives guarantee net and sharp images. NA 1,25 abbe condenser with iris diaphragm and filter holder guarantees ideal contrast.
- 142x138 mm square mechanical stage with 76 mm left-right and 55 mm back-forward movement offers easy use.
- Coarse and fine adjustment is enabled with upper limit safety with 0,002 mm fine division and 20 mm maximum moving limit. Each rotation of control knob enables 37,7 mm coarse stroke and 0,2 mm fine stroke.
- Featured with a power supply 100 Volt - 220 Volt multi input rating and easily replaceable, super bright and powerful LED illumination with adjustable light power.
- Supplied with dust cover and immersion oil.

| catalogue number | pack quantity |
|------------------|---------------|
| 613.21.001 | 1 piece |



Featured with a 360° rotatable binocular head inclined at 30° with interpupillary distance adjustable 50 mm - 75 mm.



Featured with a power supply 100 Volt - 220 Volt multi input rating and super bright LED illumination with adjustable light power.



142x138 mm square mechanical stage with 76 mm left-right and 55 mm back-forward movement offers easy use.



Coarse and fine adjustment is enabled with upper limit safety with 0,002 mm fine division and 20 mm maximum moving limit.

IMAGE PROJECTOR

- Consists of a scientific research camera with Aptina CMOS sensor for advanced video and image processing.
- Offers excellently clear projection of the images from microscopes to screens and practical photo and video shootings.
- Featured with hardware resolution among 0,35M to 14M and USB 2.0 interface for high speed data transmission. Ultra-fine color engine guarantees perfect color reproducibility.
- Other pcs are; Maximum resolution: 8.000.000 Pixels / Pixel size: 1,67 μm x 1,67 μm / Dynamic range: 65,2 dB. / SN ratio: 34 dB / Spectral range: 380 – 650 nm / Exposure: 0,38 ms – 2000 ms, ROI Auto & Manual.
- Sturdy zinc aluminium housing for a very long life cycle.

| catalogue number | pack quantity |
|------------------|---------------|
| 613.31.001 | 1 piece |





MICROSCOPE - "stereo"

- Offers ergonomic design, sharp image quality, high resolution and wide field of viewing for academic, industrial and clinical applications.
- Featured with a 360° rotating binocular head inclined at 45 with interpupillary distance adjustable 52 mm - 75 mm.
- Wide field eyepiece with 10X magnification power with 20mm view field enables bright and clear images.
- Adjustable objective with 0,7 X to 4,5X magnification power provides a wide and clear viewing field of 20 mm diameter with zoom ratio of 1:6,4
- Featured with a power supply 100 Volt - 220 Volt multi input rating and easily replaceable, super bright and powerful LED illumination from bottom and overhead.
- Supplied with dust cover, and circular examination glass plate and an additional examination plate with one side black and other side white.

| catalogue number | pack quantity |
|------------------|---------------|
| 613.22.001 | 1 piece |



Supplied with an additional examination plate with one side black and other side white.



52 - 75 mm



Featured with a 360° rotating binocular head inclined at 45 with interpupillary distance adjustable 52 mm - 75 mm.

Objective with 0,7 X to 4,5X magnification power provides a wide and clear viewing field of 20 mm diameter with zoom ratio of 1:6,4.

Featured with a power supply 100 Volt - 220 Volt multi input rating and super bright and powerful. **LED illumination from bottom.**

Featured with a power supply 100 Volt - 220 Volt multi input rating and super bright and powerful. **LED illumination from overhead.**

MICROSCOPE SMART TABLET

- Offers a built-in image capture and video record 9.7 inch touch screen tablet, with a resolution of 2048(H) x 1536(V).
- Consists of a 5.000.000 pixels camera system and 1080p video support.
- Futures for measuring line length, curve length, parallel line distance and point line distance. Also geometric measurements are available such as Radius of the circle line, three point circle and concentric circle.
- Supplied with adapting lens to convert from C-mount to 23.2 mm eyepiece tube, with 30.0 mm adaptor rings and 30.5 mm adaptor rings to fit most of the microscopes.

| catalogue number | pack quantity |
|------------------|---------------|
| 613.41.001 | 1 piece |





COVER GLASSES - "for counting chambers"



➤ Manufactured from special optical glass with ground and polished edges.

➤ These cover glasses are used to cover specimens in counting chambers.

➤ With their excellent flat surfaces they adhere perfectly on the chambers and define the volume of the cell suspension over the counting grid.

➤ Their substantial thickness of 0,4 mm offers perfect results without bending under capillary forces.

➤ Their practical dimensions of 20 x 26 mm enables use with almost chamber types.

| catalogue number | pack quantity |
|------------------|---------------|
| 075.04.001 | 10 pieces |

BLOOD COUNTING CHAMBERS

➤ Manufactured from special optical glass according to DIN 12847 standard.

➤ It is possible to count different types of cells such as leukocyte, erythrocytes with simple methods under a microscope.

➤ Tolerance of the depth of the chamber does not exceeds 2 %.

➤ Counting grids are engraved into two polished surfaces at the central station.

➤ **"Neubauer - improved" chamber** with grid consists of 3 x3 large squares with areas of 1 mm² each.

➤ **Alternative 2 chambers:**

➤ **"Thoma - new" chamber** with 0,1 mm depth. The grid covers an area of 1,1 x 1,1 mm².

➤ Supplied in a polystyrene box together with two haemocytometer cover glasses.

| catalogue number | product descriptions | pack quantity |
|------------------|----------------------|---------------|
| 075.03.001 | Neubauer Improved | 1 piece |
| 075.03.002 | Thoma - New | 1 piece |

CELL COUNTER - "mechanical"

➤ Multi use mechanical counter with maximum counting capacity up to 9999 for counting blood cells, bacterial colonies, drops of liquids, or any repetitive action.

➤ Featured a quick reset knob, lens window for easy reading, and finger ring for a secure grip.

➤ Sturdy and chrome finished metal housing offers long life cycle.



| catalogue number | pack quantity |
|------------------|---------------|
| 081.14.002 | 1 piece |



CELL COUNTER - "digital"

➤ Multi-use digital counter with maximum counting capacity up to 9999 for counting blood cells, bacterial colonies, drops of liquids, or any repetitive action.

➤ Featured a quick reset knob, lens window for easy reading, and finger ring for a secure grip.

➤ Sturdy and chrome finished metal housing offers long life cycle.

| catalogue number | pack quantity |
|------------------|---------------|
| 081.14.001 | 1 piece |

COVER GLASSES

- Manufactured from optical grade, hydrolic 1 class borosilicate glass according to DIN ISO 8255 standard.
- Fully automatic production cycles ensure dust-free, absolutely clean cover glasses with excellent flatness and smooth surfaces.
- With their thickness varying 0,13 mm - 0,17 mm they guarantee perfect clearness.
- Their edges are cut with highest precision assuring flawless results.
- **Alternative 2 glasses:** ➤ economical quality cover glasses
➤ superior quality cover glasses

| dimensions | economic quality | box quantity | superior quality | box quantity | pack quantity |
|------------|------------------|--------------|------------------|--------------|---------------|
| 18 x 18 mm | 075.00.001 | 10 packs | 075.01.001 | 10 packs | 100 pcs |
| 20 x 20 mm | 075.00.002 | 10 packs | 075.01.002 | 10 packs | 100 pcs |
| 22 x 22 mm | 075.00.003 | 10 packs | 075.01.003 | 10 packs | 100 pcs |
| 24 x 24 mm | 075.00.004 | 10 packs | 075.01.004 | 10 packs | 100 pcs |
| 24 x 32 mm | 075.00.005 | 10 packs | 075.01.005 | 10 packs | 100 pcs |
| 24 x 50 mm | 075.00.006 | 5 packs | 075.01.006 | 10 packs | 100 pcs |
| 24 x 60 mm | 075.00.007 | 5 packs | 075.01.007 | 10 packs | 100 pcs |



SLIDES

- Manufactured from optical grade, hydrolic 3 class soda lime glass according to DIN ISO 8037-1 standard.
- Fully automatic production cycles ensure dust-free, absolutely clean cover glasses with excellent flatness and smooth surfaces.
- With their extremely flat pre-cleaned surfaces free of dust and oil and their 1 mm thickness they assure flawless results.
- **Alternative 2 slides:** ➤ economical quality cover glasses
➤ superior quality cover glasses
- Superior quality color coded slides has ground edges with 45° edge angle.
- Color coded with 5 different colors enables fast, easy identification.



Superior quality color coded slides with 5 different colors provide easy identification of samples.



Superior quality slides have ground edges with 45° edge angle.



| economic quality | superior quality | product descriptions | edge angle | color code | pack quantity | box quantity |
|------------------|------------------|--|------------|------------|---------------|--------------|
| 075.05.001 | | Cut edges, Plain | 90° Degree | --- | 50 pieces | 50 packs |
| 075.05.002 | | Cut edges, Frosted one end one side | 90° Degree | --- | 50 pieces | 50 packs |
| 075.05.003 | | Ground edges, Plain | 90° Degree | --- | 50 pieces | 50 packs |
| 075.05.004 | | Ground edges, Frosted one end two side | 90° Degree | --- | 50 pieces | 50 packs |
| | 075.02.005 | Ground edges, Color Frosted | 45° Degree | white | 50 pieces | 50 packs |
| | 075.02.006 | Ground edges, Color Frosted | 45° Degree | yellow | 50 pieces | 50 packs |
| | 075.02.007 | Ground edges, Color Frosted | 45° Degree | green | 50 pieces | 50 packs |
| | 075.02.008 | Ground edges, Color Frosted | 45° Degree | pink | 50 pieces | 50 packs |
| | 075.02.009 | Ground edges, Color Frosted | 45° Degree | blue | 50 pieces | 50 packs |



SLIDE BOX - "with hinged lid"

- Manufactured from robust polypropylene providing perfect storage and transportation of slides.
- Moulded grooved slide slots with numerical index hold the microscope slides at the position.
- Hinged lid offers safe closing and easy opening. Once the lid is closed the box interior is protected from environmental effects.



SLIDE BOX - "with steel latch"

- Manufactured from robust ABS providing perfect storage and transportation of slides.
- Moulded grooved slide slots with numerical index hold the microscope slides at the position.
- Hinged lid with steel latch offers safe closing and easy opening. Once the lid is closed the box interior is protected from environmental effects.



Different color options offers easy slide classification and minimize the possibility of sample mix-up.



| slide box for 25 slides | slide box for 50 slides | slide box for 100 slides | box color | pack quantity |
|-------------------------|-------------------------|--------------------------|-----------|---------------|
| 076.02.000W | 076.02.001W | 076.02.002W | white | 1 piece |
| 076.02.000B | 076.02.001B | 076.02.002B | blue | 1 piece |
| 076.02.000P | 076.02.001P | 076.02.002P | purple | 1 piece |
| 076.02.000R | 076.02.001R | 076.02.002R | ruby | 1 piece |
| 076.02.000O | 076.02.001O | 076.02.002O | orange | 1 piece |

| catalogue number | slide capacity | box color | pack quantity |
|------------------|----------------|-----------|---------------|
| 076.02.012W | 100 slides | white | 1 piece |
| 076.02.012B | 100 slides | blue | 1 piece |
| 076.02.012R | 100 slides | ruby | 1 piece |
| 076.02.012P | 100 slides | purple | 1 piece |
| 076.02.012O | 100 slides | orange | 1 piece |



SLIDE BOX CABINET

- Manufactured from acrylate with 5 slide box compartment.
- They offer practical solutions for storing the slide boxes on top of each other. Can be linked to each other by magnetic fixators to form longer working station.

| catalogue number | pack quantity |
|------------------|---------------|
| 076.02.101 | 1 piece |



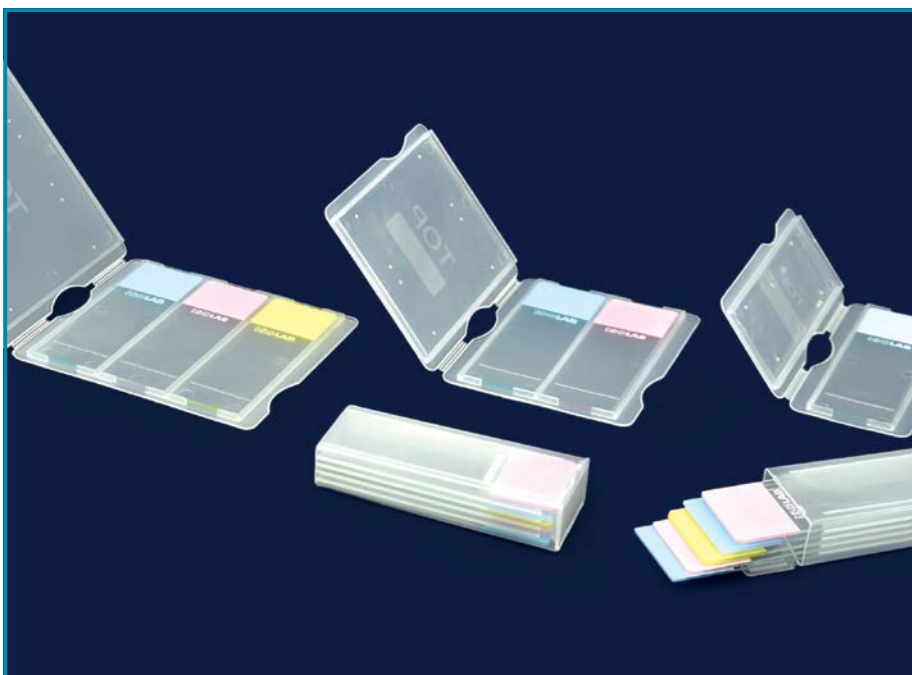

SLIDE MAILERS

- Manufactured polypropylene for storing and shipping of slides.
- Flat mailers can carry 1 or 2 or 3 slides depending on the type.
- Easy-to-close snaps hold the mailers always securely closed while keeping the interior away from dust, moisture and other environmental effects.
- Box mailer with slotted channels can hold 5 slides separated from each other.
- The hinged lid protects the mailer interior from dust and other environmental effects.

| catalogue number | slide capacity | pack quantity | box quantity |
|------------------|----------------|---------------|--------------|
| 076.05.001 | 1 slide | 1 piece | 100 pieces |
| 076.05.002 | 2 slides | 1 piece | 100 pieces |
| 076.05.003 | 3 slides | 1 piece | 100 pieces |
| 076.05.004 | 5 slides | 1 piece | 100 pieces |

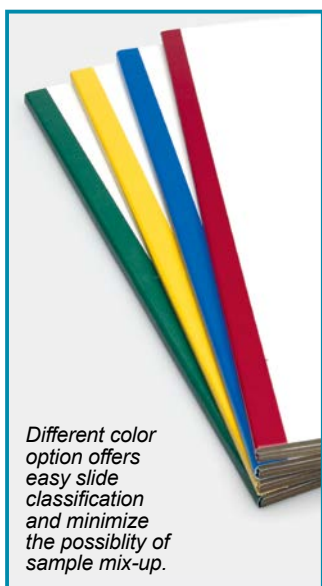

Different color option offers easy slide classification and minimize the possibility of sample mix-up.

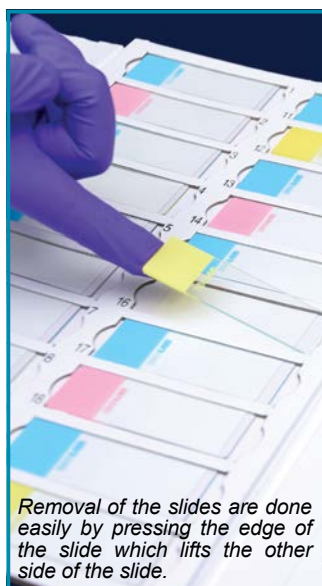

Removal of the slides are done easily by pressing the edge of the slide which lifts the other side of the slide.



SLIDE WALLETS - "cardboard"

- Manufactured from thick and robust cardboard with 20 pieces slide capacity. Consists of 2 parts: A base for slide compartments and two folding covers.
- Unique recessed design of the slide compartments avoids the risk of covers touching the slides.
- Alphanumerical index on slide rows enables easy identification of slide positions.
- Printed marking area on side walls of the covers enables easy marking and labelling.
- Slide compartments have finger slots for easy and fast removal of the slides.
- Cardboard hinged covers protect the slides from environmental effects.

SLIDE WALLET RACK

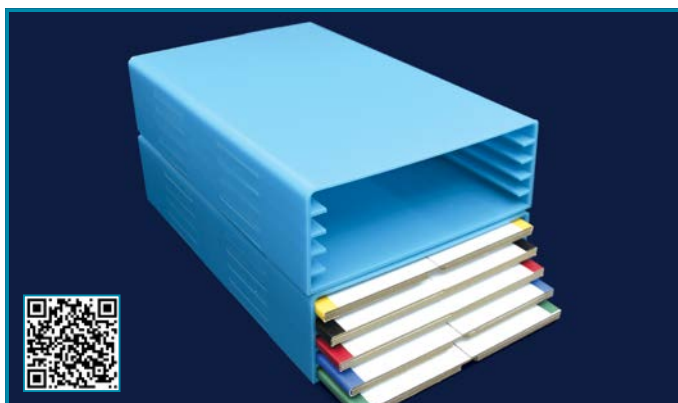

- Manufactured from thick and robust acrylic for easy and safe storage of 5 slide wallets. For easy insertion and removal of the slide wallets also protects the wallet interior.

- Easily stackable due to the body form for reducing storage space.

| catalogue number | pack quantity |
|------------------|---------------|
| 076.01.003 | 1 piece |

| catalogue number | dimension | rack color | pack quantity |
|------------------|---------------|------------|---------------|
| 076.01.001W | 205x340x10 mm | white | 1 piece |
| 076.01.001B | 205x340x10 mm | blue | 1 piece |
| 076.01.001R | 205x340x10 mm | red | 1 piece |
| 076.01.001Y | 205x340x10 mm | yellow | 1 piece |
| 076.01.001G | 205x340x10 mm | green | 1 piece |



PETRI DISHES - "glass"

- Manufactured from heat resistant glass with counter sinking process which guarantees bubble-free dishes.
- Lids perfectly fit to the body enabling easy handling.
- Extremely flat bottom base guarantees an even media dispersion and uniform cell growth.
- Fire polished body and lid edges enable safe use by reducing the risk of breakage.



| catalogue number | diameter | height | pack quantity |
|------------------|----------|--------|---------------|
| 081.01.060 | 60 mm | 15 mm | 18 pieces |
| 081.01.080 | 80 mm | 15 mm | 18 pieces |
| 081.01.100 | 100 mm | 20 mm | 18 pieces |
| 081.01.120 | 120 mm | 20 mm | 18 pieces |
| 081.01.150 | 150 mm | 25 mm | 18 pieces |

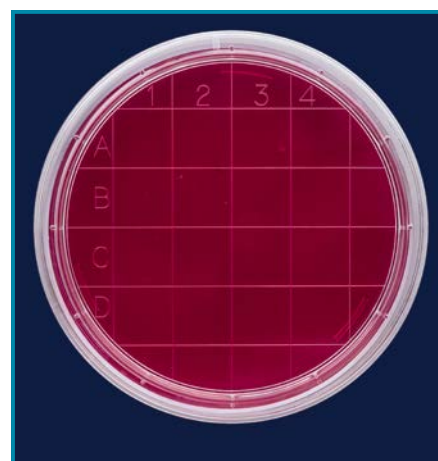

PETRI DISHES "contact" - "rodac"

➤ Manufactured from optically clear, transparent polystyrene for determining bacterial contamination of surfaces such as the skin and all other surfaces. Also facilitates the counting of colonies.

➤ Featured with a moulded grid at the bottom which enables the identification of the detected contamination / cm².

➤ Aseptic petri dishes are manufactured in germ-free, class 10.000 sterile production areas with extreme sterility control.

➤ Sterile petri dishes are manufactured in germ-free, class 10.000 sterile production areas and then resterilized by gamma irradiation.

➤ Sterile petri dishes are supplied with a certificate as a guarantee of "DNase, RNase & pyrogen free" product.

PETRI DISHES - "polystyrene" - "sterile"

➤ Manufactured from optically clear, transparent polystyrene for multiple use in microbiology and bacteriology. Manufactured by fully automatic, human touch free machines.

➤ Ideal body form guarantees excellent use with automatic filling machines. Vented lids enable consistent and effective practice.

➤ **Alternative 2 dishes:** ➤ Aseptic petri dishes
➤ Gamma sterile petri dishes

➤ Aseptic petri dishes are manufactured in germ-free, class 10.000 sterile production areas with extreme sterility control.

➤ Sterile petri dishes are manufactured in germ-free, class 10.000 sterile production areas and then resterilized by gamma irradiation. Sterile petri dishes are supplied with a certificate as a guarantee of "DNase, RNase & pyrogen free" product.

| diameter x height | section | clean room produced | box quantity | gamma sterilized | box quantity |
|-------------------|-----------|---------------------|--------------|------------------|--------------|
| 60 x 15 mm | 1 section | 081.02.061 | 500 pieces | 081.02.161 | 500 pieces |
| 90 x 17 mm | 1 section | 081.02.091 | 500 pieces | 081.02.191 | 360 pieces |
| 90 x 17 mm | 2 section | 081.02.092 | 500 pieces | 081.02.192 | 360 pieces |
| 90 x 17 mm | 3 section | 081.02.093 | 500 pieces | 081.02.193 | 360 pieces |
| 90 x 17 mm | 4 section | 081.02.094 | 500 pieces | 081.02.194 | 360 pieces |
| 120 x 17 mm | 1 section | 081.02.121 | 500 pieces | 081.02.221 | 400 pieces |

| petri dishes clean room produced | diameter x height | pack quantity | box quantity |
|----------------------------------|-------------------|---------------|--------------|
| 081.04.060 | 66 x 15 mm | 10 pieces | 500 pieces |

| petri dishes gamma sterilized | diameter x height | pack quantity | box quantity |
|-------------------------------|-------------------|---------------|--------------|
| 081.04.160 | 66 x 15 mm | 10 pieces | 500 pieces |

COLONY COUNTER



➤ Ideal for fast and practical manual counting of colonies on any agar in petri dishes. The versatile unique design accepts petri dishes from 40 mm to 100 mm.

➤ Intelligent counter with LED digitron display allows fast and precise count of the colonies between 0 - 999. Numericals on the counter can be adjusted backward and forward manually.

➤ Featured with a 90 mm high quality magnifier with 3x / 9x magnification power magnifier attached to a goose neck, flexible holder.

➤ Flexible holder enables both magnifying lens position and illumination angle adjustable in multiangular axes.

➤ Counting table is featured with a backward LED illumination with variable light control. Circular LED illumination system offers a shadow and flicker free illumination.

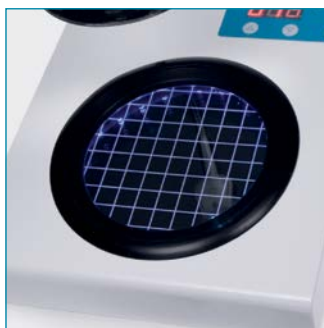

Circular LED illumination system offers a shadow and flicker free illumination without heat development with optimal concentration of light.

1 square centimeter cross sectional template of the counting plate guarantees reliable counting.



Marking is done by a "felt pin pen" which is connected to the system by cable.

Intelligent counter with LED digitron display allows fast and precise count of the colonies between 0 - 999.

| catalogue number | for petri dishes | external dimensions | pack quantity |
|------------------|------------------|---------------------|---------------|
| 603.11.001 | 40 - 100 mm dia. | 210 x 255 x 160 mm | 1 piece |

PETRI DISH BASKET - "st. steel"



➤ Manufactured from high quality, chemical and corrosion resistant AISI 304 grade stainless steel.

➤ Ideal tool for transportation and autoclaving of petri dishes with maximum 100 mm diameter.

➤ Petri dish basket can carry maximum 10 petri dish.

| catalogue number | pack quantity |
|------------------|---------------|
| 081.20.001 | 1 piece |



Sealing tape for petri dishes can be seen on catalogue page no 74.

PETRI DISH STAND



➤ Manufactured from acrylic for safe storing, transportation of petri dishes. Also very useful during inoculation and incubation.

➤ Also provides streamline benchtop sample processing and protects petri dishes from dust, moisture and other environmental effects.

➤ Center divider provides space for labelling and incorporates built in finger grip for easy handling. Can be linked to each other by the magnetic fixators at both sides.

| catalogue number | for petri dish Ø | dish capacity | pack quantity |
|------------------|------------------|---------------|---------------|
| 081.13.060 | 60 mm | 30 | 1 piece |
| 081.13.090 | 90 mm | 60 | 1 piece |

INOCULATION LOOPS - "HIPS" - "sterile"



- Aseptic inoculation loops are manufactured from HIPS in germ-free, class 10.000 sterile production areas.
- Supplied with a certificate as a guarantee of "DNase, RNase & pyrogen free" product.
- Highly flexible body form enables comfortable and efficient planting and avoids streaking of cultures.
- Anti-static property of the raw material eliminates problems caused by electrostatic effects and guarantees consistent complete liquid transfer.

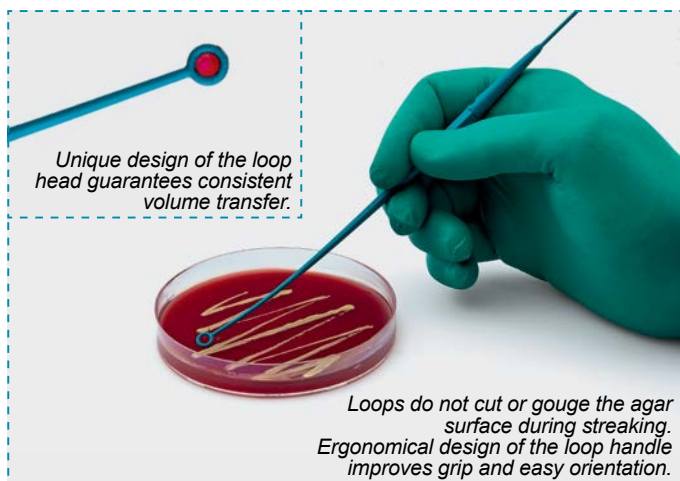

- Hexagonal loop shaft improves grip, assists orientation and makes diluting and streaking easy.
- Hexagonal loop handle also enables orientation of the loop head with a fixed angle.
- Ultra smooth loop surfaces allow easy streaking and offer problem-free planting without the risk of cutting or gauging the agar surface.
- Double use loops have one side a fine tip specially designed for holding, transporting and counting colonies. The loop at the other for streaking in petri dishes.
- Color coded loops enable fast, easy and practical identification of loop type.

| catalogue number | loops specification | loop color | pack quantity | box quantity |
|------------------|--|------------|---------------|--------------|
| 082.01.001 | one end needle / one end 1 μ l | light blue | 10 pieces | 1000 pieces |
| 082.01.002 | one end needle / one end 10 μ l | blue | 10 pieces | 1000 pieces |
| 082.01.003 | one end 1 μ l / one end 10 μ l | dark blue | 10 pieces | 1000 pieces |

INOCULATING TURNTABLE

- Light weight but robust body manufactured from aluminium and featured with non-skid feet.
- Manually operated turntable guarantees smooth and easy rotation on both directions. Also enables easy and fast allocation of bacteria across petri dish surface.
- Double sided construction accomodates petri dishes from 60 to 150 mm diameter by inverting the turntable.
- Ball bearings provide a smooth and effortless spinning ensuring rapid inoculation steps and extended operation life.
- The silicone pad holds the petri dishes firmly and keeps the dish allways in center position during inoculation steps.
- The non-skid pad can easily be removed for fast and efficient cleaning.

| catalogue number | pack quantity |
|------------------|---------------|
| 081.10.001 | 1 piece |

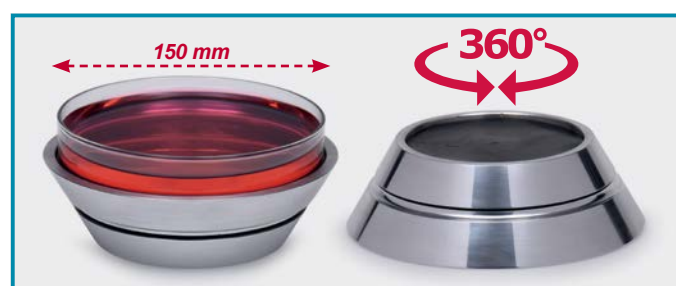
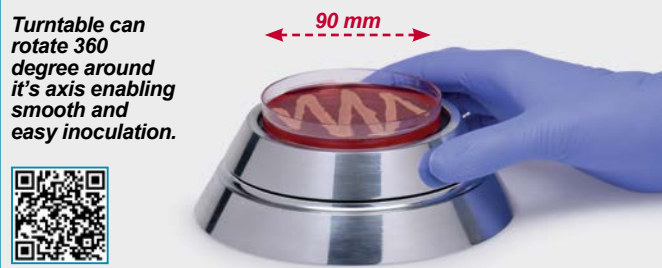



CELL SPREADER - "HIPS" - "sterile"

- Aseptic cell spreader is manufactured from HIPS in germ-free, class 10.000 sterile production areas.
- Supplied with a certificate as a guarantee of "DNase, RNase & pyrogen free" product.
- Ultra smooth, edgeless designed, triangular spreading head allows easy and problem-free spreading without the risk of cutting or gauging the agar surface.
- Highly flexible body form enables comfortable and efficient spreading and avoids streaking of cultures.
- Rippled designed ergonomic handle improves gripping efficiency and assists easy orientation of the spreader head.
- Handle flexes slightly under pressure allowing the triangular head for perfect, evenly distributed and uniform pressure on the agar surface.
- Individually single packed with lot number, production date and expiry date printed on the package.



Handle flexes slightly under pressure allowing the triangular head for perfect, evenly distributed and uniform pressure on the agar surface.

| catalogue number | pack quantity | box quantity |
|------------------|---------------|--------------|
| 082.03.001 | 1 piece | 100 pieces |



INOCULATION LOOP HANDLE

- The loop shaft is manufactured from nickel plated brass.
- The shaft of the loop handle is insulated by PVC for further protection of user against heat.
- Featured with a screw fastening end for tight fastening of the loops used.
- Handle guarantees easy holding option and fatigue-free application.

| catalogue number | length | pack quantity |
|------------------|--------|---------------|
| 082.02.003 | 200 mm | 1 piece |



INOCULATION LOOP - "stainless steel"

- These durable loops are manufactured from nickel-chrome metal wire with twisted wire strands.
- Highly flexible body form enables comfortable and efficient planting and avoids streaking of cultures.
- Ultra smooth loop surfaces allow easy streaking and offer problem-free planting without the risk of cutting or gauging the agar surface.
- Can be heated up to 1200°C and can be cooled rapidly after heat sterilisation.

| catalogue number | length | pack quantity |
|------------------|--------|---------------|
| 082.02.001 | 50 mm | 10 pieces |

CELL SPREADER - "stainless steel"

- Manufactured AISI 304 grade stainless steel. Suitable for sterilization by autoclaving or by direct flame.
- Smooth, rounded surfaces prevents any cutting or gouging of agar surface during application.
- Triangular formed spreader head enables even spreading of liquid samples all over the surface.

| catalogue number | triangular bar width | handle length | pack quantity |
|------------------|----------------------|---------------|---------------|
| 082.03.003 | 32 mm | 190 mm | 1 piece |





CELL LIFTER - "for cell culture" - "sterile"

- Manufactured from polypropylene and specially designed for scraping of attached cells on culture dishes or plate surfaces. Ideal for manual harvesting of cells.
- Manufactured in germ-free, class 10.000 sterile production areas and then resterilised by gamma irradiation.
- Supplied with a certificate of "DNase, RNase & pyrogen free" product.
- Featured with two flat ends with different widths on a single handle.
- Two blades with different widths offer practical and easy solutions during sample scraping and collection.
- Specially the wide blade end offers ideal solutions for dish and 6 well plates.
- Flat ends have 35 degree sharp edges for easy removal of the residues on flat surfaces.
- Individually single packed with lot number, production date and expiry date printed on the package.

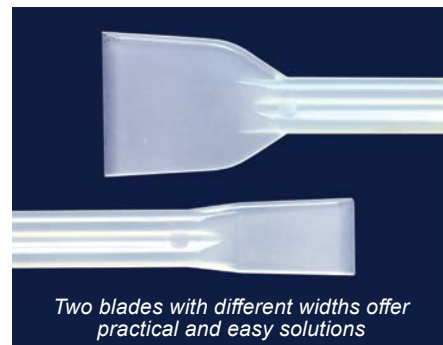

Two blades with different widths offer practical and easy solutions

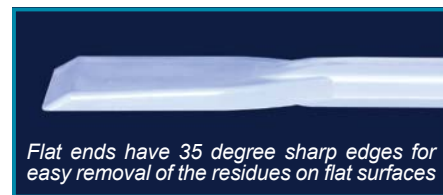

Flat ends have 35 degree sharp edges for easy removal of the residues on flat surfaces

| catalogue number | total length | narrow end width | large end width | packing specification | pack quantity |
|------------------|--------------|------------------|-----------------|-----------------------|---------------|
| 121.01.001 | 245 mm | 12 mm | 23 mm | single pack | 100 pieces |



CELL SCRAPERS - "for cell culture" - "sterile"

- Specially designed to facilitate collection of attached cells on culture dishes.
- Manufactured in germ-free, class 10.000 sterile production areas and then resterilised by gamma irradiation.
- Supplied with a certificate as a guarantee of "DNase, RNase & pyrogen free" product.
- Handle is manufactured from ABS. Scraper head is manufactured from flexible polyethylene.
- Scraper blade rotates around the it's axis enabling easy and flexible applications.
- The rotating blade also guarantees the efficient collection of cells from any angle.
- Ultra smooth blade surfaces offer problem-free collection without the risk of cutting or gauging the agar surface.
- Hexagonal shaft improves grip, assists orientation and makes diluting and streaking easy.
- Hexagonal handle also enables orientation of the loop head with a fixed angle.
- Individually single packed with lot number, production date and expiry date printed on the package.

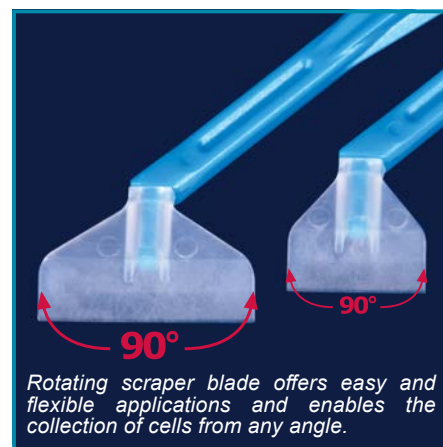

Rotating scraper blade offers easy and flexible applications and enables the collection of cells from any angle.

| catalogue number | total length | box quantity |
|------------------|--------------|--------------|
| 121.11.023 | 230 mm | 150 pieces |
| 121.12.030 | 300 mm | 150 pieces |

PIPETTES - "serological" - "polystyrene"

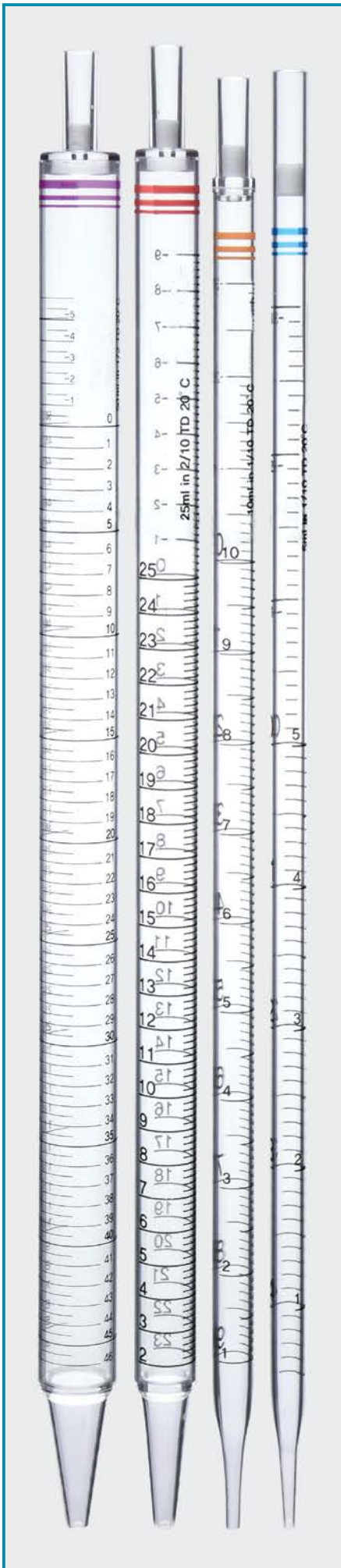

- Manufactured from virgin polystyrene with excellent optical transparency.
- Sterilized with gamma irradiation. Free of RNase, DNase, DNA and pyrogene.
- Unique design offers a smooth interior which prevents cell-hanging and clumping inside the pipette wall.
- Stable and break-resistant pipette tip offers constant the reproducible flow in each time.
- Optimised mouthpiece perfectly fits to all types of pipette pumps and balls.
- Filter plug at the mouthpiece prevents overflow of liquid and also eliminates contamination.
- Color coded ring mark at suction stem allows fast identification and sourcing.
- The sharp, black, highly visible permanent graduations prevent ambiguity and guarantee precise reading and accurate dispensing.
- Reverse graduations show actual removed or remaining volumes on all pipettes larger than 1 ml volume.
- Pipettes are supplied individually wrapped in fiber-free color coded paper as easy-to-open packing.



Volume identification by color coding on pipette enables easy volume identification during working.



Filter plug at the mouthpiece of the pipette prevents exterior effects and minimize contamination.



Accurate volume identification by highly visible bidirectional graduation printed on pipette side body.

Ascending and descending scales facilitate reading both dispensing and remaining volume.

| catalogue number | pipette volume | color code | box quantity |
|------------------|----------------|------------|--------------|
| 083.13.001 | 1 ml | yellow | 500 pieces |
| 083.13.002 | 2 ml | green | 500 pieces |
| 083.13.005 | 5 ml | blue | 200 pieces |
| 083.13.010 | 10 ml | orange | 200 pieces |
| 083.13.025 | 25 ml | red | 150 pieces |
| 083.13.050 | 50 ml | purple | 100 pieces |
| 083.13.100 | 100 ml | pink | 50 pieces |

RACK - "for pipettes"

- Manufactured from acrylic for easy organisation of all kind of pipettes.
- 4 shelves guarantee easy and fast reach of all pipettes between 1 ml to 50 ml size within arm's reach.
- Angled design of the pipette shelves prevents the risk of pipettes falling out even the shelf is fully filled.

Other technical specifications can be seen at catalogue page no 15.





STAINING JARS "Schifferdecker"

- Manufactured from heavy walled soda glass for holding microscope slides horizontally.
- Supplied together with a glass lid.
- Offers space for 10 individual microscope slides or 10 pairs of slides adjacently back-to-back.

| catalogue number | dimensions | pack quantity |
|------------------|-------------|---------------|
| 073.03.001 | 87x74x40 mm | 1 piece |



STAINING JARS "Hellendahl"

- Manufactured from heavy walled soda glass for holding microscope slides vertically.
- Supplied together with a glass lid.
- Offers space for 8 individual microscope slides or 8 pairs of slides adjacently back-to-back.

| catalogue number | dimensions | pack quantity |
|------------------|--------------|---------------|
| 073.01.001 | 60x60x105 mm | 1 piece |



STAINING JAR "Macro"

- Manufactured from heavy walled soda glass for using with a stainless steel slide holding rack.
- Supplied with a lid that provides safe closure of the jar content during non-use.
- Stainless steel staining rack is not supplied together with the jar.

| catalogue number | dimensions | pack quantity |
|------------------|--------------|---------------|
| 073.05.001 | 105x90x75 mm | 1 piece |



TISSUE BASE MOULDS

- Manufactured from stainless steel for easy removal of paraffin inclusions.
- They enable easy and precise positioning of the specimens during application.

| tissue base mold | external dimensions | internal dimensions | specifications | pack quantity |
|------------------|---------------------|---------------------|--------------------|---------------|
| 074.07.001 | 55 x 38 x 10 mm | 7 x 7 x 6 mm | biopsy & hystology | 5 pieces |
| 074.07.002 | 55 x 38 x 10 mm | 15 x 15 x 6 mm | biopsy & hystology | 5 pieces |
| 074.07.003 | 55 x 38 x 10 mm | 37 x 24 x 6 mm | standard | 5 pieces |



STAINING JAR RACK

- Manufactured from stainless steel to hold and carry microscope slides.
- Featured with inserts that can hold 20 single slides in horizontal position.
- Long handle offers easy and safe hold.

| catalogue number | dimensions | pack quantity |
|------------------|-------------|---------------|
| 073.06.001 | 85x70x20 mm | 1 piece |

EMBEDDING CASSETTES - "without lid"

- Manufactured from POM which is fully resistant to histological solvents.
- The unique design allows perfect fit to all microtome chuck adapters.
- Slanted marking area on front side enables easy marking and labelling.

| cassette without lid | color | pack quantity | box quantity |
|----------------------|--------|---------------|--------------|
| 074.01.001 | white | 500 pieces | 5000 pieces |
| 074.01.002 | yellow | 500 pieces | 5000 pieces |
| 074.01.003 | green | 500 pieces | 5000 pieces |
| 074.01.004 | pink | 500 pieces | 5000 pieces |
| 074.01.005 | blue | 500 pieces | 5000 pieces |

CASSETTE LID

- Manufactured from high quality, chemical and corrosion resistant AISI 304 grade stainless steel.
- Perforated surface offers the optimal liquid diffusion.
- The body form fits perfectly to the cassettes and guarantees tight closure.

| catalogue number | pack quantity |
|------------------|---------------|
| 074.02.001 | 5 pieces |

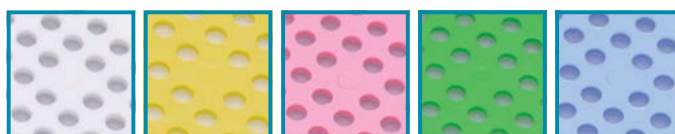

EMBEDDING CASSETTES - "with lid"

- Manufactured from POM which is fully resistant to histological solvents.
- **Histology cassettes with rectangular openings**
- **Alternative 2 cassettes:**
 - **Biopsy cassettes with square openings**
- The unique design allows perfect fit to all microtome chuck adapters.
- The efficient flow-through slots maximize the liquid exchange and also ensure proper drainage.
- The unique design of the lids can be opened and closed as often as necessary without getting loose.
- Lids always relock securely without any risk of specimen loss.
- Slanted marking area with 45° angled on front side enables easy marking and labelling.
- Histology cassettes with rectangular openings provide maximum liquid exchange and does not require use of a pad.
- Biopsy cassettes with square openings provide maximum liquid exchange and does not require use of a pad.

| cassette histology | cassette biopsy | color | pack quantity | box quantity |
|--------------------|-----------------|--------|---------------|--------------|
| 074.03.001 | 074.04.001 | white | 500 pieces | 5000 pieces |
| 074.03.002 | 074.04.002 | yellow | 500 pieces | 5000 pieces |
| 074.03.003 | 074.04.003 | green | 500 pieces | 5000 pieces |
| 074.03.004 | 074.04.004 | pink | 500 pieces | 5000 pieces |
| 074.03.005 | 074.04.005 | blue | 500 pieces | 5000 pieces |

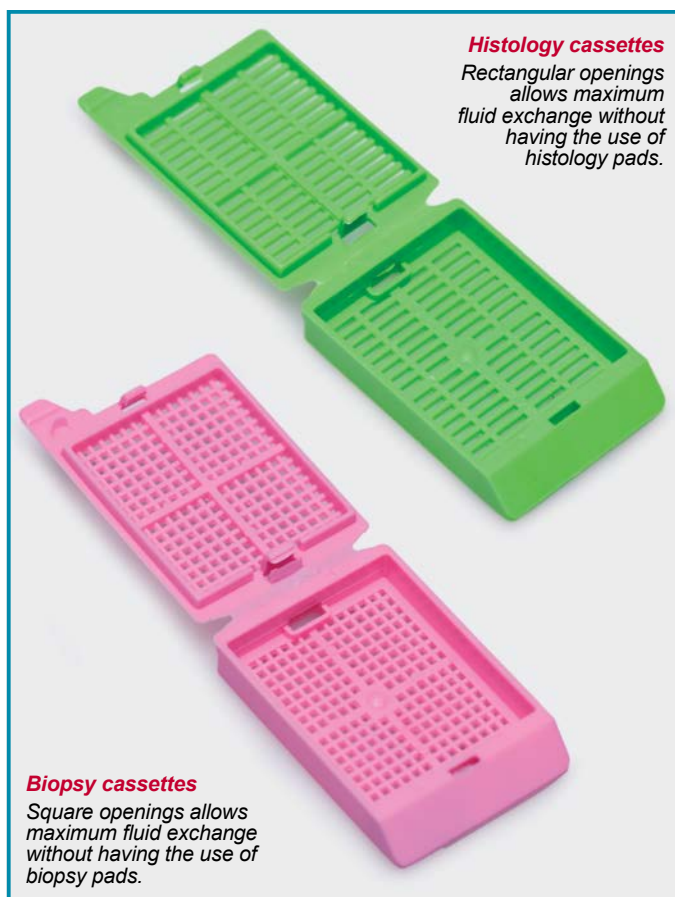

Histology cassettes
Rectangular openings allows maximum fluid exchange without having the use of histology pads.

Biopsy cassettes
Square openings allows maximum fluid exchange without having the use of biopsy pads.

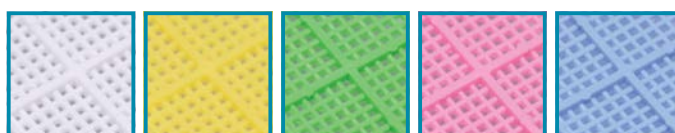



MICRO - HAEMATOCRIT TUBES

➤ Manufactured by fully automatic machines according to ISO 12772 and BS 4316-68 standards with 75 mm length and 0,2 mm wall thickness.

➤ **Alternative 2 tube types:**

➤ **Non-heparinised tubes with blue color tip.**

➤ **Heparinised tubes with red color tip.**

➤ Interior surface of heparinised tubes are covered with sodium heparinate.

| catalogue number | tube type | vial quantity | box quantity |
|------------------|-----------------|---------------|--------------|
| 088.02.001 | heparinised | 100 pcs | 10 vials |
| 088.02.002 | non-heparinised | 100 pcs | 10 vials |

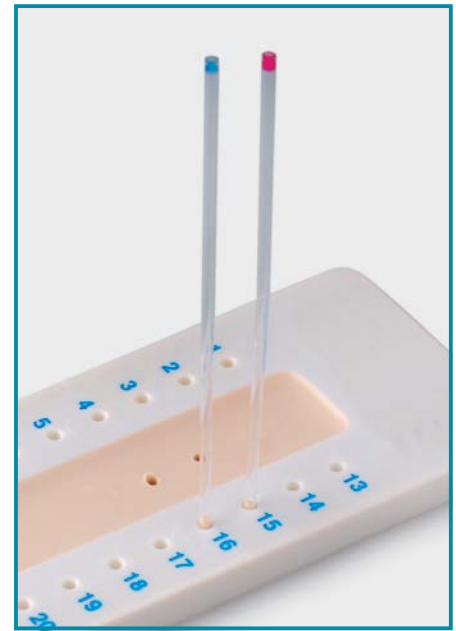

MICRO - HAEMATOCRIT TUBE WAX

➤ Offers fast and safe solutions for sealing of the micro haematocrit tube ends.

➤ Can carry 48 tubes with 2 x 24 array.

➤ Numerical index on the tray provides easy identification of tube positions

➤ This non drying sealing compound has a life time of 3 years at room conditions.

| catalogue number | tube capacity | pack quantity |
|------------------|---------------|---------------|
| 088.03.001 | 48 tubes | 10 pieces |



Lancets are very incisive and have very sharp edges which penetrates into the skin very easily.

BLOOD LANCETS "manual"

➤ Manufactured from medical grade stainless steel.

➤ Featured with very sharp blade end that penetrates into the skin easily without pain.

➤ Single use and gamma sterilized and individually packed.

| catalogue number | pack quantity | box quantity |
|------------------|---------------|--------------|
| 088.01.001 | 200 pieces | 50 pack |

BLOOD LANCETS - "automatic"

➤ Offers perfect protection since the needle is always been fully shielded "before" and "after" use.

➤ Featured with ultra sharp needle with high speed penetration of 1,8 mm depth.

➤ Single use and gamma sterilized and individually packed.

| catalogue number | pack quantity | box quantity |
|------------------|---------------|--------------|
| 088.02.003 | 100 pieces | 5 packs |



Twist off the protective safety cap first.



Hold the lancet firmly on the finger site



Press the release button to activate the lancet



Gently press the finger to let the blood drop out

| | | | | | |
|---------------------------------|---------|---------------------------|---------|-----------------------------------|----------------|
| ADAPTERS | | BOSSHEADS | | Burette clamps | 12 |
| 2 necks | 84 | for stirrers | 160-161 | Büchner funnels | 104 |
| 2 necks - 45° | 84 | heavy duty | 51 | Caps | 134 |
| 2 necks - 75° | 84 | standard | 51 | Carboys | 40 |
| 3 necks | 84-85 | swivel | 51 | Carrier for bottles | 42 |
| bend | 83 | | | Cell counters | 198 |
| bend - 75° | 84 | BOTTLES | | CELL CULTURES | |
| bend - 90° | 84 | aluminium | 33 | cap - aluminium | 29 |
| bend- with stopcock | 84 | aspirator | 40 | cell lifter | 206 |
| delivery | 85-88 | dropping | 41 | cell scraper | 206 |
| distilling heads | 85 | filter | 106 | cell sparaders | 205 |
| expansion | 82 | ISO - coated glass | 30 | erlenmeyer | 29 |
| PTFE | 87 | ISO - polypropylene | 31 | erlenmeyer - baffed | 29 |
| receiving | 88 | polyethylene- for liquids | 34 | flasks | 192 |
| reduction | 82 | polyethylene- for powders | 35 | inaculation loop - steel | 205 |
| splash heads | 85 | security seal cutter | 32 | inoculation loop handle | 205 |
| straight | 83 | spraying | 38 | inoculation loops - HIPS | 204 |
| straight - with stopcock | 83 | square | 32 | inoculation turn table | 204 |
| tube - micro | 184 | wash | 38-39 | multiwell plate | 193 |
| with screw cap | 82 | water sampling | 36 | petri dish | 193 |
| with screw thread | 82 | wide neck | 33 | | |
| with stopcock | 83 | burette | 12 | Cell sparaders | 205 |
| | | gas wash | 89 | | |
| Aluminium disc | 72 | | | CENTRIFUGE | |
| Aluminium foil | 72 | BOXES | | clinical | 114 |
| Aluminium foil dispenser | 72 | click lock | 43 | mini | 112 |
| Aquadur test strips | 149 | cryo - cardboard | 189 | mini - high speed | 113 |
| Arsenic estimator | 90 | cryo - polycarbonate | 189 | | |
| | | cryo - polypropylene | 188 | Centrifuge tubes | 44-180-181-184 |
| AUTOCLAVES | | dispenser | 13-43 | Ceramic triangle | 49 |
| indicator roll | 119 | double opening | 43 | Chemical pads | 135 |
| vertical | 119 | for nitrile gloves | 133 | Chromatography columns | 94 |
| | | safety | 123 | | |
| BAGS | | slide | 200 | CLAMPS | |
| autoclavable | 78 | transport | 42 | 2 jaws | 50 |
| bag latches | 79-80 | tube - cardboard | 182 | 3 jaws | 50 |
| homogenization | 80 | vial | 175 | burette | 12 |
| homogenization - stand | 80 | with compartments | 42 | click lock | 67 |
| locks | 79 | | | for frame work | 50 |
| stand | 78 | BRUSHES | | hoffman | 67 |
| with wire closure | 79 | burette | 117 | for KS joints | 98 |
| zip lock | 79 | dish washing | 122 | for vacuum filter set | 160 |
| | | intensive cleaning | 122 | thermometer | 51 |
| BALANCES | | laboratory | 116-117 | tube | 52 |
| 0.0001 g precision | 150 | | | worm drive screw | 67 |
| 0.001 g precision | 150 | BUCKETS | 123 | | |
| 0.01 g precision | 150-151 | | | Cleaning towel dispenser | 122 |
| 0.1 g precision | 151 | BUNSEN BURNERS | | Cleaning towels | 122 |
| | | advanced | 61 | | |
| BASKETS | | hose | 61 | CLIPS | |
| basket for bottles | 42 | meker | 61 | for NS joints | 91 |
| carrier for bottles | 42 | stabilizer | 61 | | |
| petri dish | 203 | standard | 61 | Colony counter | 203 |
| | | | | Columns for chromatography | 94 |
| Beads - glass | 87 | BURETTES | | | |
| | | bottles | 12 | CONDENSERS | |
| BEAKERS | | automatic | 11 | allihn | 92 |
| glass | 26 | bellow | 12 | allihn - for soxhlet | 94 |
| polypropylene | 26 | digital - manuel | 18 | dimroth | 93 |
| PTFE | 26 | schilling | 12 | dimroth - for soxhlet | 95 |
| stainless steel | 26 | straight | 11 | liebig | 92 |
| with handle | 27 | | | spiral | 93 |
| | | | | | |
| Blood counting chambers | 198 | | | | |
| Blood lancets | 210 | | | | |

| | | | | | |
|---------------------------------------|---------|--|---------|-----------------------------------|-----|
| Conductivity solution | 146 | Embedding cassettes | 209 | FUNNELS | |
| Containers | 37 | | | analytical | 102 |
| Cover glass forcep | 58 | ERLENMEYERS | | büchner | 104 |
| Cover glasses | 199 | cell culture | 29 | dropping | 111 |
| Cover glasses - blood counting | 198 | cell culture - baffed | 29 | glass - plain | 102 |
| Crimpers | 174 | glass | 28 | glass - powder | 102 |
| | | glass - ground neck | 96 | gooch | 105 |
| CRUCIBLES | | screw cap | 28 | holders | 103 |
| alsint | 65 | | | polypropylene - plain | 102 |
| gooch | 105 | Estimator - arsenic | 90 | polypropylene - powder | 102 |
| lids | 65 | Estimator - water | 90 | polypropylene - ribbed | 102 |
| porcelain | 65 | Evaporating Dishes | 64 | separating | 110 |
| stainless steel | 64 | Evaporating dish tong | 52 | | |
| | | Extractor thimbles | 95 | Gas wash bottle heads | 89 |
| Crucible tongs | 52 | Extractors - soxhlet | 95 | Gas wash bottles | 89 |
| | | Eye wash bottle stand | 129 | Gaskets | 105 |
| CRYO | | Eye wash bottles | 128-129 | GHS pictograms | 74 |
| box - cardboard | 189 | | | Glass beads | 87 |
| box - polycarbonate | 189 | FILMS | | | |
| box - polypropylene | 188 | parafilm | 70 | GLOVES | |
| cryo cap inserts | 185 | parafilm dispenser | 71 | box | 133 |
| Cryo tube canes | 185 | stretch | 70 | cold protection | 131 |
| tube | 185 | | | finger protectors | 133 |
| work station | 188 | FILTER | | heat protection | 131 |
| | | membrane | 167 | neopren | 132 |
| CRYSTALLIZATION DISHES | | | | nitrile | 130 |
| glass | 64 | Filter flasks | 104 | nitrile - chemical protection | 132 |
| stainless steel | 64 | Filter flasks for vacuum system | 107 | safe handling | 131 |
| | | Filter paper forcep | 108 | silicone | 133 |
| Cumbostion boat | 64 | Filter papers | 108 | thermal resistance | 132 |
| Cutters | 59 | Finger protectors | 133 | | |
| Cutting tool for tapes | 74 | | | Goggle | 124 |
| | | FLASKS | | Gooch crucible | 105 |
| CUVETTES | | 2 ground neck | 97 | Gooch funnel | 105 |
| boxes | 177 | 3 ground neck | 97 | Grease | 91 |
| glass | 176-177 | amber - ground neck | 96 | Ground joints | 82 |
| polystyrene | 176 | cell culture | 192 | Heating Mantles | 163 |
| quartz | 176-177 | evaporating | 98 | | |
| | | filter | 104 | HOMOGENIZERS | |
| Cylinders | 10 | flat bottom | 27 | clamp - for heavy duty | |
| Decappers | 174 | flat bottom - ground neck | 97 | homogenizer | 161 |
| Density bottles | 154 | kjehldahl | 98 | clamp - for light duty | |
| Desiccators | 62 | nitrogen | 99 | homogenizer | 161 |
| Desiccant beads | 62 | pear shape | 98 | heavy duty | 161 |
| Desk Protectors | 135 | receiving | 98 | light duty | 161 |
| | | round bottom | 27 | rotor set | 161 |
| DISPENSERS | | round bottom - ground neck | 97 | | |
| advanced | 19 | volumetric | 8-9 | Homogenization bag latches | 80 |
| repetitive | 18 | | | Homogenization bag stands | 80 |
| tips | 18 | Flask stands | 99 | Homogenization bags | 80 |
| | | Flow indicator | 109 | Hose for bunsen burner | 61 |
| Dispenser boxes | 13-43 | | | Imhoff cone stands | 154 |
| Dissecting needle set | 60 | FORCEPS | | Imhoff cones | 154 |
| Distilling heads | 85 | ABS | 58 | Incinerating dishes | 65 |
| Distilling links | 86-87 | cover glasses | 58 | Inoculation loop - steel | 205 |
| DO electrolyte solution | 146 | dissecting | 58 | Inoculation loop handle | 205 |
| DO probe | 146 | filter paper | 108 | Inoculation loops - HIPS | 204 |
| Draining racks | 118 | general use | 58 | Inoculation turn table | 204 |
| Dropping bottles | 41 | | | | |
| Dropping funnels | 111 | JARS | | glass | 37 |
| Drying tubes | 89 | | | polypropylene | 37 |
| Ear muff | 126 | | | Staining jar rack | 208 |
| Ear plugs | 126 | | | staining jars | 208 |
| | | ELECTRODES | | | |
| | | conductivity | 146 | | |
| | | ORP | 146 | | |
| | | pH | 146 | | |

| | | | | | |
|----------------------------------|---------|--|-------|--------------------------------------|---------|
| Jerrycans | 40 | Micro haematocrit tubes | 210 | Qualitative filter papers | 108 |
| Joint grease | 91 | Micropipette pipetting reservoirs | 20 | Quantitative filter papers | 108 |
| Joint sleeves | 91 | Micropipette tips | 22-23 | Quantofix test strips | 149 |
| Knives | 59 | Mortars | 63 | Refractometers | 195 |
| LABELS | | Multiwell plates | 193 | Rotary evaporator spare parts | 101 |
| <i>circular form</i> | 76 | Non-return valve | 109 | Rotary evaporators | 101 |
| <i>rectangular form</i> | 75-77 | Over shoes | 134 | Safety box tray | 123 |
| <i>safety</i> | 74 | Parafilm | 70 | Safety boxes | 123 |
| | | Parafilm dispenser | 71 | Safety shield | 126 |
| Label dispenser | 76 | PCR | | SCALPELS | |
| Label remover | 76 | <i>plates</i> | 191 | <i>blades</i> | 60 |
| Labelling tapes | 75 | <i>sealing film</i> | 191 | <i>handles</i> | 60 |
| Laboratory jack | 49 | <i>sealing tape</i> | 191 | <i>with safety cover</i> | 60 |
| LABORATORY STANDS | | <i>strips</i> | 190 | SCISSORS | |
| <i>ABS</i> | 49 | <i>tubes</i> | 190 | <i>disecting</i> | 59 |
| <i>horse shoe</i> | 48 | <i>work station</i> | 191 | <i>for hose cutting</i> | 66 |
| <i>rectangular</i> | 48 | Pehanon test strips | 148 | <i>general use</i> | 59 |
| <i>support rods</i> | 48 | PEN | | <i>heavy duty</i> | 59 |
| <i>triangle</i> | 48 | <i>double tip</i> | 73 | SCOOPS | |
| <i>tripod</i> | 49 | <i>engraving</i> | 73 | <i>self standing - polypropyle</i> | 54 |
| | | <i>single tip</i> | 73 | <i>self standing - polystyrene</i> | 55 |
| Laboratory tissue | 122 | Pestles | 63 | <i>stainless steel</i> | 56 |
| LED light source | 126 | PETRI DISH | | Screw caps | 69 |
| Lens cleaning tissue | 127 | <i>basket</i> | 203 | Sealing tape - PTFE | 91 |
| Lithmus paper | 148 | <i>cell culture</i> | 193 | Security seal | 32 |
| MAGNETIC STIRRERS | | <i>glass</i> | 202 | Separating funnels | 110 |
| <i>with hot plate</i> | 156 | <i>polystyrene</i> | 202 | Silica-Gel | 62 |
| <i>w/o hot plate</i> | 157 | <i>rodac</i> | 202 | Sleeves | 91 |
| Magnetic stirring bars | 158 | <i>stands</i> | 203 | SLIDES | |
| Magnifier | 194 | Petri dish sealing tape | 74 | <i>box cabinet</i> | 200 |
| Manifolds | 106 | pH - portable | 144 | <i>boxes</i> | 200 |
| Masks | 136 | pH - table top | 145 | <i>mailers</i> | 201 |
| MECHANICAL STIRRERS | | pH buffer solutions | 147 | <i>wallet rack</i> | 201 |
| <i>light duty</i> | 160 | pH indicator strips | 148 | <i>wallets - cardboard</i> | 201 |
| <i>mechanical - heavy duty</i> | 160 | pH paper roll | 148 | <i>slides</i> | 199 |
| Mechanical stirrer shafts | 160 | PIPETTES | | Soaking solution | 146 |
| Membrane filters | 167 | <i>graduated</i> | 14 | Soxhlet extractors | 95 |
| METERS | 144-145 | <i>pasteur - glass</i> | 13 | SPATULAS | |
| MICROPIPETTES | | <i>pasteur - polyethylene</i> | 13 | <i>chattaway</i> | 53 |
| <i>8 channel</i> | 21 | <i>pasteur pipette bulb</i> | 13 | <i>curved end</i> | 53 |
| <i>single channel</i> | 20-21 | <i>serological</i> | 207 | <i>double end</i> | 53 |
| <i>stands</i> | 24 | <i>volumetric</i> | 14 | <i>flat knife</i> | 53 |
| MICROSCOPES | | Pipette boxes | 15 | <i>macro spoon</i> | 53 |
| <i>biological</i> | 196 | Pipette bulb | 16 | <i>macro spoon - polypropylene</i> | 57 |
| <i>Image projector</i> | 196 | Pipette fillers | 16 | <i>micro spoon</i> | 53 |
| <i>stereo</i> | 197 | Pipette pump - electrical | 17 | <i>poly</i> | 53 |
| Microscope smart tablet | 197 | Pipette rack | 15 | <i>round grooved</i> | 53 |
| MIXERS | | Pipette tray | 15 | <i>with lid</i> | 57 |
| <i>vortex</i> | 164 | Pipette stands | 14-15 | Spectacle cabinet | 127 |
| | | Protective suits | 134 | Spectacles | 124-125 |
| | | PUMPS | | Spectrophotometer cuvettes | 176-177 |
| | | <i>vacuum & pressure</i> | 109 | SPOONS | |
| | | <i>water jet</i> | 109 | <i>polystyrene</i> | 56 |
| | | | | <i>stainless steel</i> | 56 |
| | | | | Stabilising rings | 28 |
| | | | | Staining jar rack | 208 |
| | | | | Staining jars | 208 |

product index

| | | | | | |
|---|------------|----------------------------|------------|-----------------------------------|--------------|
| STANDS | | Thermometer | 138 | TUBINGS | |
| eye wash bottle | 129 | Thermometer adapter | 82 | clamps - click lock | 67 |
| imhoff cone | 154 | Thermometer clamp | 138 | clamps - hoffmann | 67 |
| petri dish | 203 | Thimbles | 95 | clamps - worm drive screw | 67 |
| laboratory | 48-49 | TIMERS | | PTFE | 66 |
| thermometer | 138 | electronic | 143 | rubber - standard | 66 |
| STIRRERS | | mechanical | 142 | rubber - vacuum | 66 |
| magnetic - w/o hot plate | 157 | Tissue | 122 | scissor | 66 |
| magnetic - with hot plate | 156 | Tissue base moulds | 208 | silicone | 66 |
| mechanical - heavy duty | 160 | TLC | | Tubing connectors | 67 |
| mechanical - light duty | 160 | separation tank | 178 | Ultrasonic cleaners | 121 |
| Stirrer shafts | 160 | spray kit | 178 | VACUUM | |
| Stirring rods | 159 | sprayer | 178 | filter set | 107 |
| STOPPERS | | Tongs | 52 | flask | 107 |
| cellulose | 68 | Towel dispenser | 122 | manifolds | 107 |
| cork | 68 | Towels | 122 | pumps | 109 |
| flange | 69 | Transport box | 42 | support base | 107 |
| glass | 69 | TRAYS | | Vacuum filter set | 107 |
| polypropylene | 69 | pipette | 15 | Valve | 109 |
| rubber | 68 | polypropylene | 123 | VIALS | |
| rubber - drilled | 69 | stainless steel | 123 | box | 175 |
| silicone | 68 | TUBES | | crimper & decapper | 174 |
| turn over flange | 68 | PCR strips | 190 | N11 - crimp cap | 172 |
| Stopwatches | 142 | qPCR strips | 190 | N11 caps& septas | 172 |
| SYRINGES | | centrifuge - glass | 44 | N13 - screw cap | 172 |
| glass | 169 | centrifuge - screw cap | 180 | N15 - screw cap | 172 |
| polypropylene | 166 | centrifuge - screw cap - | | N15 caps& septas | 172 |
| serie H | 169 | self standing | 181 | N20 - crimp cap | 173 |
| serie H - removable needle | 169 | cryo | 185 | N20 caps& septas | 173 |
| serie RN - removable needle | 168 | cryo cap insert | 185 | N24 - screw cap | 174 |
| serie T | 168 | drying | 89 | N8 - screw cap | 171 |
| Syringe Filters | 166 | micro | 184 | N8 caps& septas | 171 |
| TAPES | | test - glass | 44 | N8 insert | 171 |
| cutting tool | 74 | test - polypropylene | 44 | N9 - screw cap | 171 |
| for labelling | 75 | test - polystyrene | 44 | N9 - screw cap with insert | 171 |
| sealing - petri | 74 | test - polystyrene | 44 | N9 insert | 171 |
| sealing - PTFE | 91 | tube adapter - micro | 184 | racks | 175 |
| Tape dispenser | 75 | TUBE BOXES | | Visitor gowns | 134 |
| Temperature probe | 146 | cardboard | 182 | VOLUMETRIC FLASKS | |
| Test indicator - steam sterilization | 119 | cryo | 188-189 | glass | 8 |
| TEST STRIPS | | Tube clamps | 52 | glass - coated | 8 |
| aquadur | 149 | TUBE RACKS | | polypropylene | 9 |
| pehanon | 148 | 4 sides | 46 | trapezoidal | 9 |
| peroxide | 149 | dismantled | 46 | Wash bottles | 38-39 |
| pH indicator strips | 148 | epoxy coated steel | 45 | Watch glasses | 153 |
| pH paper roll | 148 | foldable | 47-183 | Water estimator | 90 |
| water hardness | 149 | hedgehod design | 182 | Water hardness test strips | 149 |
| Thermohygrometer | 140 | micro tube - 3 tier | 187 | WATER STILLS | |
| Thermohygrometer - portable | 139 | micro tube - base support | 186 | automatic | 100 |
| THERMOMETERS | | micro tube - double side | 187 | basic | 100 |
| desk top | 140-141 | micro tube - foldable | 186 | filter | 100 |
| glass | 138 | PCR tube | 191 | WEIGHING | |
| max-min - humidity | 141 | push&hold | 181 | brush | 153 |
| portable | 139 | snappable | 183 | dishes - square form | 152 |
| | | stainless steel | 45 | dishes - aluminium | 152 |
| | | with silicone grips | 45 | dishes - diamond form | 152 |
| | | | | papers | 153 |
| | | | | scoops | 153 |
| | | | | Wire gauze | 48 |

| catalogue no // page | catalogue no // page | catalogue no // page | catalogue no // page | catalogue no // page | catalogue no // page |
|----------------------|----------------------|----------------------|----------------------|----------------------|----------------------|
| 005.01.001 → 23 | 011.20.100 → 21 | 014.01.100 → 8 | 019.01.025 → 11 | 025.01.400 → 26 | 028.01.052 → 96 |
| 005.01.002 → 23 | 011.20.200 → 21 | 014.01.100C → 8 | 019.01.050 → 11 | 025.01.600 → 26 | 028.01.053 → 96 |
| 005.01.003 → 23 | 011.20.901 → 21 | 014.01.101 → 8 | 019.05.010 → 11 | 025.01.800 → 26 | 028.01.100 → 96 |
| 005.01.004 → 23 | 011.20.905 → 21 | 014.01.101C → 8 | 019.05.025 → 11 | 025.01.901 → 26 | 028.01.101 → 96 |
| 005.01.005 → 23 | 011.20.910 → 21 | 014.01.200 → 8 | 019.05.050 → 11 | 025.01.902 → 26 | 028.01.102 → 96 |
| 005.01.015 → 23 | 011.21.010 → 21 | 014.01.200C → 8 | 020.03.010 → 12 | 025.01.905 → 26 | 028.01.103 → 96 |
| 006.03.030 → 20 | 011.21.050 → 21 | 014.01.250 → 8 | 020.03.025 → 12 | 025.01.910 → 26 | 028.01.250 → 96 |
| 006.03.055 → 20 | 011.21.200 → 21 | 014.01.250C → 8 | 020.03.050 → 12 | 025.03.050 → 26 | 028.01.251 → 96 |
| 006.03.110 → 20 | 011.21.300 → 21 | 014.01.500 → 8 | 020.05.010 → 12 | 025.03.100 → 26 | 028.01.252 → 96 |
| 006.05.001 → 24 | 013.01.005 → 8 | 014.01.500C → 8 | 020.05.025 → 12 | 025.03.250 → 26 | 028.01.300 → 96 |
| 006.11.005 → 24 | 013.01.005C → 8 | 014.01.901 → 8 | 020.05.050 → 12 | 025.03.500 → 26 | 028.01.500 → 96 |
| 006.11.006 → 24 | 013.01.010 → 8 | 014.01.901C → 8 | 020.07.010 → 12 | 025.03.901 → 26 | 028.01.501 → 96 |
| 006.12.004 → 24 | 013.01.010C → 8 | 014.01.902 → 8 | 020.07.025 → 12 | 025.04.100 → 26 | 028.01.502 → 96 |
| 006.12.006 → 24 | 013.01.020 → 8 | 014.01.902C → 8 | 020.08.001 → 12 | 025.04.250 → 26 | 028.01.901 → 96 |
| 006.13.030 → 20 | 013.01.020C → 8 | 014.03.025 → 9 | 021.01.001 → 14 | 025.04.500 → 26 | 028.01.902 → 96 |
| 006.13.055 → 20 | 013.01.025 → 8 | 014.03.050 → 9 | 021.01.002 → 14 | 025.04.901 → 26 | 028.03.050 → 28 |
| 006.13.110 → 20 | 013.01.025C → 8 | 014.03.100 → 9 | 021.01.005 → 14 | 025.05.500 → 27 | 028.03.100 → 28 |
| 006.15.001 → 43 | 013.01.026 → 8 | 014.03.250 → 9 | 021.01.010 → 14 | 025.05.901 → 27 | 028.03.250 → 28 |
| 006.15.002 → 43 | 013.01.026C → 8 | 014.03.500 → 9 | 021.01.020 → 14 | 025.05.902 → 27 | 028.03.500 → 28 |
| 006.15.003 → 43 | 013.01.050 → 8 | 014.03.901 → 9 | 021.01.025 → 14 | 026.01.025 → 26 | 028.03.901 → 28 |
| 007.01.002 → 18 | 013.01.050C → 8 | 014.13.025 → 9 | 021.01.050 → 14 | 026.01.050 → 26 | 028.11.053 → 96 |
| 008.06.001 → 18 | 013.01.051 → 8 | 014.13.050 → 9 | 021.05.001 → 14 | 026.01.100 → 26 | 028.11.103 → 96 |
| 008.06.002 → 18 | 013.01.051C → 8 | 014.13.100 → 9 | 021.05.002 → 14 | 026.01.250 → 26 | 028.11.252 → 96 |
| 008.06.005 → 18 | 013.01.100 → 8 | 014.13.250 → 9 | 021.05.003 → 14 | 026.01.500 → 26 | 028.11.502 → 96 |
| 008.06.012 → 18 | 013.01.100C → 8 | 014.13.500 → 9 | 021.05.004 → 14 | 026.01.901 → 26 | 028.11.901 → 96 |
| 008.06.025 → 18 | 013.01.101 → 8 | 014.13.901 → 9 | 021.05.005 → 14 | 026.01.902 → 26 | 028.11.902 → 96 |
| 008.06.050 → 18 | 013.01.101C → 8 | 015.01.005 → 10 | 021.05.010 → 14 | 026.02.250 → 27 | 029.01.050 → 27 |
| 008.06.125 → 18 | 013.01.150 → 8 | 015.01.010 → 10 | 021.05.011 → 14 | 026.02.500 → 27 | 029.01.100 → 27 |
| 008.06.250 → 18 | 013.01.150C → 8 | 015.01.025 → 10 | 021.05.015 → 14 | 026.02.901 → 27 | 029.01.250 → 27 |
| 008.06.500 → 18 | 013.01.200 → 8 | 015.01.050 → 10 | 021.05.020 → 14 | 026.02.902 → 27 | 029.01.500 → 27 |
| 008.12.002 → 19 | 013.01.200C → 8 | 015.01.100 → 10 | 021.05.025 → 14 | 026.02.903 → 27 | 029.01.901 → 27 |
| 008.12.005 → 19 | 013.01.250 → 8 | 015.01.250 → 10 | 021.05.050 → 14 | 026.03.001 → 52 | 029.01.902 → 27 |
| 008.12.010 → 19 | 013.01.250C → 8 | 015.01.500 → 10 | 021.11.001 → 14 | 026.03.002 → 52 | 029.01.904 → 27 |
| 008.12.030 → 19 | 013.01.300 → 8 | 015.01.901 → 10 | 021.11.002 → 14 | 026.03.025 → 26 | 029.01.906 → 27 |
| 008.12.060 → 19 | 013.01.300C → 8 | 015.01.902 → 10 | 021.11.005 → 14 | 026.03.050 → 26 | 029.01.910 → 27 |
| 008.12.100 → 19 | 013.01.400 → 8 | 016.01.010 → 10 | 021.11.010 → 14 | 026.03.100 → 26 | 029.02.050 → 27 |
| 008.15.002 → 19 | 013.01.400C → 8 | 016.01.025 → 10 | 021.11.020 → 14 | 026.03.250 → 26 | 029.02.100 → 27 |
| 008.15.005 → 19 | 013.01.500 → 8 | 016.01.050 → 10 | 021.11.025 → 14 | 026.03.500 → 26 | 029.02.250 → 27 |
| 008.15.010 → 19 | 013.01.500C → 8 | 016.01.100 → 10 | 021.11.050 → 14 | 026.03.901 → 26 | 029.02.500 → 27 |
| 008.15.030 → 19 | 013.01.901 → 8 | 016.01.250 → 10 | 021.15.001 → 14 | 026.03.902 → 26 | 029.02.901 → 27 |
| 008.15.060 → 19 | 013.01.901C → 8 | 016.01.500 → 10 | 021.15.002 → 14 | 026.04.250 → 27 | 029.02.902 → 27 |
| 008.15.100 → 19 | 013.01.902 → 8 | 016.01.901 → 10 | 021.15.005 → 14 | 026.04.500 → 27 | 029.02.904 → 27 |
| 010.01.005 → 17 | 013.01.902C → 8 | 016.05.010 → 10 | 021.15.010 → 14 | 026.04.901 → 27 | 029.02.906 → 27 |
| 010.01.006 → 17 | 013.01.905 → 8 | 016.05.025 → 10 | 021.15.015 → 14 | 026.04.902 → 27 | 029.02.910 → 27 |
| 011.01.002 → 16 | 013.01.910 → 8 | 016.05.050 → 10 | 021.15.020 → 14 | 026.04.903 → 27 | 029.03.001 → 52 |
| 011.01.010 → 16 | 013.13.001 → 9 | 016.05.100 → 10 | 021.15.025 → 14 | 027.01.025 → 28 | 029.03.002 → 52 |
| 011.01.025 → 16 | 013.13.002 → 9 | 016.05.250 → 10 | 022.01.001 → 14 | 027.01.050 → 28 | 029.04.001 → 99 |
| 011.02.001 → 16 | 013.13.003 → 9 | 016.05.500 → 10 | 022.02.001 → 15 | 027.01.100 → 28 | 029.04.002 → 99 |
| 011.02.002 → 16 | 013.13.004 → 9 | 016.05.901 → 10 | 022.03.001 → 15 | 027.01.250 → 28 | 029.04.003 → 99 |
| 011.02.003 → 16 | 013.13.005 → 9 | 016.06.010 → 10 | 022.03.002 → 15 | 027.01.300 → 28 | 029.04.004 → 99 |
| 011.02.003.3 → 16 | 013.13.010 → 9 | 016.06.025 → 10 | 022.03.003 → 15 | 027.01.500 → 28 | 029.14.902 → 99 |
| 011.04.001 → 16 | 013.13.020 → 9 | 016.06.050 → 10 | 022.03.011 → 15 | 027.01.901 → 28 | 030.01.050 → 96 |
| 011.04.003 → 16 | 013.13.025 → 9 | 016.06.100 → 10 | 022.04.001 → 15 | 027.01.902 → 28 | 030.01.051 → 96 |
| 011.04.005 → 16 | 013.13.050 → 9 | 016.06.250 → 10 | 022.04.002 → 15 | 027.01.903 → 28 | 030.01.052 → 96 |
| 011.04.010 → 16 | 013.15.001 → 9 | 016.06.500 → 10 | 022.06.001 → 15 | 027.01.905 → 28 | 030.01.053 → 96 |
| 011.05.002 → 20 | 013.15.002 → 9 | 016.06.901 → 10 | 023.01.005 → 154 | 027.03.100 → 28 | 030.01.100 → 96 |
| 011.05.010 → 20 | 013.15.003 → 9 | 016.07.010 → 10 | 023.01.010 → 154 | 027.03.250 → 28 | 030.01.101 → 96 |
| 011.05.020 → 20 | 013.15.004 → 9 | 016.07.025 → 10 | 023.01.025 → 154 | 027.03.500 → 28 | 030.01.102 → 96 |
| 011.05.050 → 20 | 013.15.005 → 9 | 016.07.050 → 10 | 023.01.050 → 154 | 027.03.901 → 28 | 030.01.103 → 96 |
| 011.05.100 → 20 | 013.15.010 → 9 | 016.07.100 → 10 | 023.01.100 → 154 | 027.06.100 → 29 | 030.01.250 → 96 |
| 011.05.200 → 20 | 013.15.020 → 9 | 016.07.250 → 10 | 023.02.005 → 154 | 027.06.101 → 29 | 030.01.251 → 96 |
| 011.05.901 → 20 | 013.15.025 → 9 | 016.07.500 → 10 | 023.02.010 → 154 | 027.06.250 → 29 | 030.01.252 → 96 |
| 011.05.905 → 20 | 013.15.050 → 9 | 016.07.901 → 10 | 023.02.025 → 154 | 027.06.500 → 29 | 030.01.500 → 96 |
| 011.05.910 → 20 | 014.01.005 → 8 | 017.01.010 → 11 | 023.02.050 → 154 | 027.06.901 → 29 | 030.01.501 → 96 |
| 011.06.002 → 20 | 014.01.005C → 8 | 017.01.025 → 11 | 023.02.100 → 154 | 027.06.902 → 29 | 030.01.900 → 96 |
| 011.06.010 → 20 | 014.01.010 → 8 | 017.01.050 → 11 | 023.03.005 → 154 | 027.11.048 → 28 | 030.01.901 → 96 |
| 011.06.020 → 20 | 014.01.010C → 8 | 017.02.010 → 11 | 023.03.010 → 154 | 027.11.056 → 28 | 030.01.902 → 96 |
| 011.06.050 → 20 | 014.01.020 → 8 | 017.02.025 → 11 | 023.03.025 → 154 | 027.11.061 → 28 | 030.01.904 → 96 |
| 011.06.100 → 20 | 014.01.020C → 8 | 017.02.050 → 11 | 023.03.050 → 154 | 027.11.074 → 28 | 030.02.050 → 96 |
| 011.06.200 → 20 | 014.01.025 → 8 | 018.01.010 → 11 | 023.03.100 → 154 | 027.17.250 → 29 | 030.02.051 → 96 |
| 011.06.901 → 20 | 014.01.025C → 8 | 018.01.025 → 11 | 025.01.005 → 26 | 027.17.500 → 29 | 030.02.052 → 96 |
| 011.06.905 → 20 | 014.01.026 → 8 | 018.01.050 → 11 | 025.01.010 → 26 | 027.17.901 → 29 | 030.02.053 → 96 |
| 011.06.910 → 20 | 014.01.026C → 8 | 018.05.001 → 12 | 025.01.025 → 26 | 027.18.250 → 29 | 030.02.100 → 96 |
| 011.20.002 → 21 | 014.01.050 → 8 | 018.05.002 → 12 | 025.01.050 → 26 | 027.18.500 → 29 | 030.02.101 → 96 |
| 011.20.010 → 21 | 014.01.050C → 8 | 018.06.001 → 12 | 025.01.100 → 26 | 027.18.901 → 29 | 030.02.102 → 96 |
| 011.20.020 → 21 | 014.01.051 → 8 | 018.06.002 → 12 | 025.01.150 → 26 | 028.01.050 → 96 | 030.02.103 → 96 |
| 011.20.050 → 21 | 014.01.051C → 8 | 019.01.010 → 11 | 025.01.250 → 26 | 028.01.051 → 96 | 030.02.250 → 96 |

product index

| catalogue no // page | catalogue no // page | catalogue no // page | catalogue no // page | catalogue no // page | catalogue no // page |
|----------------------|----------------------|----------------------|----------------------|----------------------|----------------------|
| 030.02.251 → 96 | 030.40.500 → 97 | 032.01.250 → 111 | 036.01.100 → 95 | 037.30.500B → 54 | 038.14.100 → 64 |
| 030.02.252 → 96 | 030.40.901 → 97 | 032.01.500 → 111 | 036.01.150 → 95 | 037.30.500W → 54 | 038.14.H30 → 65 |
| 030.02.500 → 96 | 030.41.250 → 97 | 032.01.901 → 111 | 036.01.250 → 95 | 037.30.901B → 54 | 038.14.H35 → 65 |
| 030.02.501 → 96 | 030.41.500 → 97 | 032.02.050 → 111 | 036.01.500 → 95 | 037.30.901W → 54 | 038.14.H40 → 65 |
| 030.02.900 → 96 | 030.41.901 → 97 | 032.02.100 → 111 | 037.01.050 → 153 | 037.32.001 → 153 | 038.14.H46 → 65 |
| 030.02.901 → 96 | 030.41.902 → 97 | 032.02.250 → 111 | 037.01.060 → 153 | 037.33.001 → 153 | 038.14.H51 → 65 |
| 030.02.902 → 96 | 030.42.250 → 97 | 032.02.500 → 111 | 037.01.070 → 153 | 037.35.025B → 55 | 038.14.H60 → 65 |
| 030.02.904 → 96 | 030.43.250 → 97 | 032.02.901 → 111 | 037.01.080 → 153 | 037.35.025W → 55 | 038.14.L30 → 65 |
| 030.12.053 → 96 | 030.43.500 → 97 | 032.03.050 → 111 | 037.01.100 → 153 | 037.35.050B → 55 | 038.14.L35 → 65 |
| 030.12.103 → 96 | 030.43.901 → 97 | 032.03.100 → 111 | 037.01.125 → 153 | 037.35.050W → 55 | 038.14.L40 → 65 |
| 030.12.252 → 96 | 030.44.250 → 97 | 032.03.250 → 111 | 037.01.150 → 153 | 037.35.100B → 55 | 038.14.L45 → 65 |
| 030.12.501 → 96 | 030.44.500 → 97 | 032.03.500 → 111 | 037.01.200 → 153 | 037.35.100W → 55 | 038.14.L50 → 65 |
| 030.12.901 → 96 | 030.44.901 → 97 | 032.03.901 → 111 | 037.02.254 → 153 | 037.35.150B → 55 | 038.14.L60 → 65 |
| 030.24.050 → 97 | 030.44.902 → 97 | 033.11.160 → 92 | 037.02.305 → 153 | 037.35.150W → 55 | 038.14.L70 → 65 |
| 030.24.100 → 97 | 030.45.250 → 97 | 033.11.250 → 92 | 037.02.353 → 153 | 037.35.250B → 55 | 038.14.M35 → 65 |
| 030.24.250 → 97 | 030.45.500 → 97 | 033.11.252 → 92 | 037.02.357 → 153 | 037.35.250W → 55 | 038.14.M40 → 65 |
| 030.25.100 → 97 | 030.45.901 → 97 | 033.11.253 → 92 | 037.02.402 → 153 | 037.35.500B → 55 | 038.14.M45 → 65 |
| 030.25.250 → 97 | 030.46.250 → 97 | 033.11.400 → 92 | 037.02.408 → 153 | 037.35.500W → 55 | 038.14.M50 → 65 |
| 030.25.500 → 97 | 030.46.500 → 97 | 033.11.402 → 92 | 037.02.503 → 153 | 037.36.001 → 57 | 038.14.M60 → 65 |
| 030.25.901 → 97 | 030.46.901 → 97 | 033.11.403 → 92 | 037.02.508 → 153 | 037.36.002 → 56 | 038.14.M70 → 65 |
| 030.26.100 → 97 | 030.47.250 → 97 | 033.12.160 → 92 | 037.02.603 → 153 | 037.36.010 → 56 | 038.14.M82 → 65 |
| 030.26.250 → 97 | 030.47.500 → 97 | 033.12.250 → 92 | 037.02.803 → 153 | 037.36.025W → 55 | 038.17.001 → 64 |
| 030.26.500 → 97 | 030.47.901 → 97 | 033.12.252 → 92 | 037.04.001 → 153 | 037.36.050W → 55 | 038.18.065 → 63 |
| 030.26.901 → 97 | 030.47.902 → 97 | 033.12.253 → 92 | 037.04.002 → 153 | 037.36.100W → 55 | 038.18.085 → 63 |
| 030.27.100 → 97 | 030.49.010 → 98 | 033.12.400 → 92 | 037.04.003 → 153 | 037.36.150W → 55 | 038.18.110 → 63 |
| 030.27.250 → 97 | 030.49.025 → 98 | 033.12.402 → 92 | 037.05.005 → 152 | 037.36.250W → 55 | 038.18.125 → 63 |
| 030.27.500 → 97 | 030.49.050 → 98 | 033.12.403 → 92 | 037.05.030 → 152 | 037.36.500W → 55 | 038.18.150 → 63 |
| 030.27.901 → 97 | 030.49.100 → 98 | 033.13.160 → 92 | 037.05.100 → 152 | 038.02.065 → 63 | 038.19.035 → 65 |
| 030.27.902 → 97 | 030.49.250 → 98 | 033.13.250 → 92 | 037.06.005 → 152 | 038.02.090 → 63 | 038.19.043 → 65 |
| 030.28.100 → 97 | 030.52.050 → 98 | 033.13.252 → 92 | 037.06.030 → 152 | 038.02.130 → 63 | 038.19.046 → 65 |
| 030.28.250 → 97 | 030.52.100 → 98 | 033.13.253 → 92 | 037.06.100 → 152 | 038.02.150 → 63 | 038.19.052 → 65 |
| 030.28.500 → 97 | 030.52.250 → 98 | 033.13.400 → 92 | 037.07.001 → 153 | 038.02.180 → 63 | 038.19.060 → 65 |
| 030.28.901 → 97 | 030.55.100 → 98 | 033.13.402 → 92 | 037.07.002 → 153 | 038.03.115 → 63 | 038.19.068 → 65 |
| 030.28.902 → 97 | 030.55.250 → 98 | 033.13.403 → 92 | 037.07.003 → 153 | 038.03.135 → 63 | 038.20.025 → 65 |
| 030.29.100 → 97 | 030.55.500 → 98 | 033.14.160 → 92 | 037.08.050 → 56 | 038.03.150 → 63 | 038.20.046 → 65 |
| 030.29.250 → 97 | 030.55.901 → 98 | 033.14.250 → 92 | 037.08.075 → 56 | 038.03.175 → 63 | 038.20.055 → 65 |
| 030.29.500 → 97 | 030.56.100 → 98 | 033.14.252 → 92 | 037.08.100 → 56 | 038.03.210 → 63 | 038.21.040 → 65 |
| 030.29.901 → 97 | 030.56.250 → 98 | 033.14.253 → 92 | 037.08.120 → 56 | 038.05.001 → 52 | 038.21.050 → 65 |
| 030.29.902 → 97 | 030.56.500 → 98 | 033.14.400 → 92 | 037.09.007 → 152 | 038.06.250 → 52 | 038.21.060 → 65 |
| 030.30.050 → 97 | 030.56.901 → 98 | 033.14.402 → 92 | 037.09.100 → 152 | 038.06.300 → 52 | 039.01.200 → 62 |
| 030.30.100 → 97 | 030.57.100 → 98 | 033.14.403 → 92 | 037.09.250 → 152 | 038.06.400 → 52 | 039.01.250 → 62 |
| 030.30.250 → 97 | 030.57.250 → 98 | 033.15.160 → 93 | 037.11.007 → 152 | 038.07.050 → 63 | 039.01.300 → 62 |
| 030.31.100 → 97 | 030.57.500 → 98 | 033.15.253 → 93 | 037.11.100 → 152 | 038.07.075 → 63 | 039.02.200 → 62 |
| 030.31.250 → 97 | 030.57.750 → 98 | 033.15.403 → 93 | 037.11.250 → 152 | 038.07.100 → 63 | 039.02.250 → 62 |
| 030.31.500 → 97 | 030.57.901 → 98 | 033.16.160 → 93 | 037.15.005 → 152 | 038.07.125 → 63 | 039.02.300 → 62 |
| 030.31.901 → 97 | 030.58.025 → 99 | 033.16.253 → 93 | 037.15.030 → 152 | 038.07.150 → 63 | 039.05.200 → 62 |
| 030.32.100 → 97 | 030.58.050 → 99 | 033.16.403 → 93 | 037.15.100 → 152 | 038.08.050 → 63 | 039.05.250 → 62 |
| 030.32.250 → 97 | 030.58.100 → 99 | 033.17.160 → 93 | 037.16.005 → 152 | 038.08.075 → 63 | 039.05.300 → 62 |
| 030.32.500 → 97 | 030.58.250 → 99 | 033.17.163 → 93 | 037.16.030 → 152 | 038.08.100 → 63 | 039.06.200 → 62 |
| 030.32.901 → 97 | 030.59.050 → 99 | 033.17.250 → 93 | 037.16.100 → 152 | 038.08.125 → 63 | 039.06.250 → 62 |
| 030.33.100 → 97 | 030.59.100 → 99 | 033.17.253 → 93 | 037.19.007 → 152 | 038.08.150 → 63 | 039.06.300 → 62 |
| 030.33.250 → 97 | 030.59.250 → 99 | 033.17.400 → 93 | 037.19.100 → 152 | 038.09.060 → 63 | 039.07.200 → 62 |
| 030.33.500 → 97 | 030.59.500 → 99 | 033.17.403 → 93 | 037.19.250 → 152 | 038.09.070 → 63 | 039.07.250 → 62 |
| 030.33.901 → 97 | 030.59.901 → 99 | 033.18.160 → 93 | 037.21.007 → 152 | 038.09.080 → 63 | 039.07.300 → 62 |
| 030.33.902 → 97 | 030.60.003 → 87 | 033.18.163 → 93 | 037.21.100 → 152 | 038.09.100 → 63 | 039.08.100 → 79 |
| 030.34.100 → 97 | 030.60.004 → 87 | 033.18.250 → 93 | 037.21.250 → 152 | 038.09.120 → 63 | 039.08.150 → 79 |
| 030.34.250 → 97 | 030.60.005 → 87 | 033.18.253 → 93 | 037.23.070 → 152 | 038.11.060 → 64 | 039.08.220 → 79 |
| 030.34.500 → 97 | 030.60.006 → 87 | 033.18.400 → 93 | 037.23.085 → 152 | 038.11.080 → 64 | 039.08.300 → 79 |
| 030.34.901 → 97 | 031.02.050 → 110 | 033.18.403 → 93 | 037.23.110 → 152 | 038.11.100 → 64 | 039.12.200 → 62 |
| 030.34.902 → 97 | 031.02.100 → 110 | 035.11.030 → 94 | 037.24.045 → 152 | 038.11.125 → 64 | 039.12.250 → 62 |
| 030.35.100 → 97 | 031.02.250 → 110 | 035.11.070 → 94 | 037.24.055 → 152 | 038.11.160 → 64 | 039.12.300 → 62 |
| 030.35.250 → 97 | 031.02.500 → 110 | 035.11.250 → 94 | 037.24.065 → 152 | 038.12.060 → 64 | 039.16.001 → 62 |
| 030.35.500 → 97 | 031.02.901 → 110 | 035.11.500 → 94 | 037.25.100 → 152 | 038.12.080 → 64 | 039.20.001 → 78 |
| 030.35.901 → 97 | 031.02.902 → 110 | 035.12.030 → 94 | 037.30.002B → 54 | 038.12.100 → 64 | 039.20.002 → 78 |
| 030.35.902 → 97 | 031.04.050 → 110 | 035.12.070 → 94 | 037.30.002W → 54 | 038.12.125 → 64 | 039.20.003 → 78 |
| 030.36.250 → 97 | 031.04.100 → 110 | 035.12.250 → 94 | 037.30.005B → 54 | 038.12.160 → 64 | 039.21.001 → 79 |
| 030.37.250 → 97 | 031.04.250 → 110 | 035.12.500 → 94 | 037.30.005W → 54 | 038.13.A30 → 65 | 039.21.002 → 79 |
| 030.37.500 → 97 | 031.04.500 → 110 | 035.13.030 → 95 | 037.30.010B → 54 | 038.13.A41 → 65 | 039.21.003 → 79 |
| 030.37.901 → 97 | 031.04.901 → 110 | 035.13.070 → 95 | 037.30.010W → 54 | 038.13.A48 → 65 | 039.21.004 → 79 |
| 030.38.250 → 97 | 031.04.902 → 110 | 035.13.250 → 95 | 037.30.025B → 54 | 038.13.A54 → 65 | 039.21.005 → 79 |
| 030.38.500 → 97 | 031.06.050 → 110 | 035.13.500 → 95 | 037.30.025W → 54 | 038.13.A60 → 65 | 039.23.001 → 80 |
| 030.38.901 → 97 | 031.06.100 → 110 | 035.14.030 → 95 | 037.30.050B → 54 | 038.13.A66 → 65 | 039.23.002 → 80 |
| 030.38.902 → 97 | 031.06.250 → 110 | 035.14.070 → 95 | 037.30.050W → 54 | 038.13.S35 → 64 | 039.23.003 → 80 |
| 030.39.250 → 97 | 031.06.500 → 110 | 035.14.250 → 95 | 037.30.100B → 54 | 038.13.S45 → 64 | 039.30.001 → 78 |
| 030.39.500 → 97 | 031.06.901 → 110 | 035.14.500 → 95 | 037.30.100W → 54 | 038.13.S50 → 64 | 039.30.002 → 78 |
| 030.39.901 → 97 | 032.01.050 → 111 | 036.01.030 → 95 | 037.30.250B → 54 | 038.14.060 → 64 | 039.30.003 → 78 |
| 030.40.250 → 97 | 032.01.100 → 111 | 036.01.070 → 95 | 037.30.250W → 54 | 038.14.080 → 64 | 039.30.004 → 78 |

| catalogue no // page | catalogue no // page | catalogue no // page | catalogue no // page | catalogue no // page | catalogue no // page |
|----------------------|----------------------|----------------------|----------------------|----------------------|----------------------|
| 039.30.005 → 78 | 043.01.121 → 105 | 047.10.200 → 53 | 049.09.250 → 48 | 051.21.007 → 69 | 052.12.008 → 66 |
| 039.34.105 → 79 | 043.01.122 → 105 | 047.10.300 → 53 | 049.09.320 → 48 | 051.21.008 → 69 | 052.13.001 → 66 |
| 039.34.150 → 79 | 043.01.123 → 105 | 047.18.001 → 56 | 050.01.001 → 61 | 051.21.009 → 69 | 052.13.002 → 66 |
| 039.35.075 → 79 | 043.01.124 → 105 | 047.18.002 → 56 | 050.01.002 → 61 | 051.21.010 → 69 | 052.13.003 → 66 |
| 039.35.145 → 79 | 043.01.501 → 105 | 047.32.150 → 57 | 050.01.003 → 61 | 051.22.001 → 68 | 052.13.004 → 66 |
| 039.35.200 → 79 | 043.01.502 → 105 | 047.32.180 → 57 | 050.04.001 → 49 | 051.22.002 → 68 | 052.13.005 → 66 |
| 040.01.100 → 104 | 043.01.503 → 105 | 047.32.210 → 57 | 050.04.002 → 49 | 051.22.003 → 68 | 052.13.006 → 66 |
| 040.01.250 → 104 | 043.01.504 → 105 | 047.33.150 → 57 | 050.05.150 → 49 | 051.22.004 → 68 | 052.13.007 → 66 |
| 040.01.500 → 104 | 043.02.031 → 105 | 047.33.180 → 57 | 050.05.200 → 49 | 051.22.005 → 68 | 052.13.008 → 66 |
| 040.01.901 → 104 | 043.02.032 → 105 | 047.33.210 → 57 | 050.06.001 → 48 | 051.22.006 → 68 | 052.13.009 → 66 |
| 040.01.902 → 104 | 043.02.033 → 105 | 048.01.105 → 58 | 050.07.050 → 49 | 051.22.007 → 68 | 052.15.010B → 67 |
| 040.02.100 → 104 | 043.02.034 → 105 | 048.01.115 → 58 | 050.07.060 → 49 | 051.22.008 → 68 | 052.15.010O → 67 |
| 040.02.250 → 104 | 043.02.051 → 105 | 048.01.130 → 58 | 050.08.075 → 61 | 051.22.009 → 68 | 052.15.010R → 67 |
| 040.02.500 → 104 | 043.02.052 → 105 | 048.01.145 → 58 | 050.08.100 → 61 | 051.22.010 → 68 | 052.15.015B → 67 |
| 040.02.901 → 104 | 043.02.053 → 105 | 048.01.160 → 58 | 050.09.001 → 61 | 051.22.011 → 68 | 052.15.015O → 67 |
| 040.02.902 → 104 | 043.02.054 → 105 | 048.01.200 → 58 | 051.03.001 → 69 | 051.22.012 → 68 | 052.15.015R → 67 |
| 040.05.001 → 104 | 043.03.001 → 107 | 048.01.250 → 58 | 051.03.002 → 69 | 051.22.013 → 68 | 052.15.020B → 67 |
| 040.05.002 → 104 | 043.03.002 → 107 | 048.01.300 → 58 | 051.03.003 → 69 | 051.22.014 → 68 | 052.15.020O → 67 |
| 040.05.003 → 104 | 043.03.003 → 107 | 048.02.115 → 58 | 051.03.004 → 69 | 051.22.015 → 68 | 052.15.020R → 67 |
| 040.05.004 → 104 | 043.03.004 → 107 | 048.02.130 → 58 | 051.03.005 → 69 | 051.22.016 → 68 | 052.16.012 → 67 |
| 040.06.001 → 105 | 043.03.005 → 107 | 048.02.145 → 58 | 051.03.006 → 69 | 051.22.017 → 68 | 052.16.016 → 67 |
| 040.10.001 → 109 | 043.03.006 → 107 | 048.02.160 → 58 | 051.03.007 → 69 | 051.22.018 → 68 | 052.16.020 → 67 |
| 040.10.005 → 109 | 043.03.007 → 107 | 048.03.001 → 58 | 051.04.001 → 69 | 051.22.019 → 68 | 052.16.025 → 67 |
| 041.01.040 → 102 | 043.05.101 → 106 | 048.03.002 → 58 | 051.04.002 → 69 | 051.22.020 → 68 | 052.17.012 → 67 |
| 041.01.060 → 102 | 043.05.103 → 106 | 048.04.001 → 108 | 051.04.003 → 69 | 051.22.021 → 68 | 052.17.020 → 67 |
| 041.01.080 → 102 | 043.05.106 → 106 | 048.06.001 → 59 | 051.04.004 → 69 | 051.22.022 → 68 | 052.17.030 → 67 |
| 041.01.100 → 102 | 043.06.001 → 106 | 048.06.002 → 59 | 051.04.005 → 69 | 051.23.001 → 68 | 052.18.001 → 109 |
| 041.01.120 → 102 | 043.06.011 → 106 | 048.07.105 → 58 | 051.04.006 → 69 | 051.23.002 → 68 | 052.22.006 → 67 |
| 041.01.150 → 102 | 043.08.015 → 105 | 048.07.115 → 58 | 051.04.007 → 69 | 051.23.003 → 68 | 052.22.008 → 67 |
| 041.02.040 → 102 | 043.08.030 → 105 | 048.07.130 → 58 | 051.08.010 → 69 | 051.23.004 → 68 | 052.22.010 → 67 |
| 041.02.060 → 102 | 043.08.050 → 105 | 048.07.150 → 58 | 051.08.012 → 69 | 051.23.005 → 68 | 052.23.006 → 67 |
| 041.02.080 → 102 | 043.20.001 → 154 | 048.07.160 → 58 | 051.08.014 → 69 | 051.23.006 → 68 | 052.23.008 → 67 |
| 041.02.100 → 102 | 043.20.002 → 154 | 048.07.200 → 58 | 051.08.019 → 69 | 051.23.007 → 68 | 052.23.010 → 67 |
| 041.02.120 → 102 | 043.22.002 → 154 | 048.08.105 → 58 | 051.08.024 → 69 | 051.23.008 → 68 | 052.24.006 → 67 |
| 041.02.150 → 102 | 045.01.001 → 50 | 048.08.115 → 58 | 051.08.029 → 69 | 051.23.009 → 68 | 052.24.008 → 67 |
| 041.03.080 → 102 | 045.03.001 → 50 | 048.08.130 → 58 | 051.09.45B → 69 | 051.23.010 → 68 | 052.24.010 → 67 |
| 041.04.040 → 102 | 045.04.001 → 50 | 048.10.110 → 58 | 051.09.45G → 69 | 051.23.011 → 68 | 052.25.006 → 67 |
| 041.05.040 → 102 | 045.06.001 → 50 | 048.11.110 → 58 | 051.09.45R → 69 | 051.23.012 → 68 | 052.25.008 → 67 |
| 041.05.060 → 102 | 046.01.001 → 51 | 048.22.130 → 59 | 051.09.45Y → 69 | 051.23.013 → 68 | 052.25.010 → 67 |
| 041.05.080 → 102 | 046.01.002 → 51 | 048.22.160 → 59 | 051.10.001 → 69 | 051.23.014 → 68 | 052.30.001 → 60 |
| 041.05.100 → 102 | 046.05.001 → 51 | 048.23.130 → 59 | 051.10.002 → 69 | 051.23.015 → 68 | 055.01.001 → 142 |
| 041.05.120 → 102 | 046.05.002 → 51 | 048.23.160 → 59 | 051.10.003 → 69 | 051.23.016 → 68 | 055.02.001 → 142 |
| 041.05.150 → 102 | 046.07.001 → 50 | 048.24.130 → 59 | 051.10.004 → 69 | 051.23.017 → 68 | 055.03.001 → 142 |
| 041.07.065 → 102 | 047.01.120 → 53 | 048.24.160 → 59 | 051.10.005 → 69 | 051.23.018 → 68 | 055.04.001 → 142 |
| 041.07.080 → 102 | 047.01.150 → 53 | 048.25.130 → 59 | 051.11.001 → 69 | 051.23.019 → 68 | 056.01.001 → 142 |
| 041.07.100 → 102 | 047.01.180 → 53 | 048.26.130 → 59 | 051.11.002 → 69 | 051.23.020 → 68 | 056.02.001 → 143 |
| 041.07.120 → 102 | 047.01.210 → 53 | 048.30.130 → 59 | 051.11.003 → 69 | 051.23.021 → 68 | 056.03.001 → 143 |
| 041.07.150 → 102 | 047.01.250 → 53 | 048.30.160 → 59 | 051.11.004 → 69 | 051.23.022 → 68 | 056.04.001 → 143 |
| 041.08.060 → 102 | 047.01.300 → 53 | 048.30.200 → 59 | 051.11.005 → 69 | 051.24.009 → 29 | 057.01.010 → 158 |
| 041.08.080 → 102 | 047.02.150 → 53 | 048.31.001 → 59 | 051.20.001 → 68 | 051.26.001 → 68 | 057.01.015 → 158 |
| 041.08.100 → 102 | 047.02.180 → 53 | 048.50.001 → 60 | 051.20.002 → 68 | 051.26.002 → 68 | 057.01.020 → 158 |
| 041.08.120 → 102 | 047.02.210 → 53 | 048.50.002 → 60 | 051.20.003 → 68 | 051.26.003 → 68 | 057.01.025 → 158 |
| 042.01.070 → 104 | 047.03.150 → 53 | 048.50.003 → 60 | 051.20.004 → 68 | 051.26.004 → 68 | 057.01.030 → 158 |
| 042.01.090 → 104 | 047.03.180 → 53 | 048.51.010 → 60 | 051.20.005 → 68 | 051.26.005 → 68 | 057.01.035 → 158 |
| 042.01.110 → 104 | 047.03.210 → 53 | 048.51.011 → 60 | 051.20.006 → 68 | 051.26.006 → 68 | 057.01.040 → 158 |
| 042.02.070 → 104 | 047.05.001 → 54 | 048.51.021 → 60 | 051.20.007 → 68 | 051.26.007 → 68 | 057.01.045 → 158 |
| 042.02.090 → 104 | 047.05.002 → 54 | 049.01.130 → 48 | 051.20.008 → 68 | 051.26.008 → 68 | 057.01.050 → 158 |
| 042.02.110 → 104 | 047.06.150 → 53 | 049.01.150 → 48 | 051.20.009 → 68 | 052.08.002 → 66 | 057.01.060 → 158 |
| 042.03.040 → 103 | 047.06.180 → 53 | 049.01.200 → 48 | 051.20.010 → 68 | 052.10.001 → 66 | 057.01.070 → 158 |
| 042.03.060 → 103 | 047.06.210 → 53 | 049.03.115 → 48 | 051.20.011 → 68 | 052.10.002 → 66 | 057.01.080 → 158 |
| 042.03.080 → 103 | 047.07.130 → 53 | 049.03.150 → 48 | 051.20.012 → 68 | 052.10.003 → 66 | 057.02.001 → 159 |
| 042.03.100 → 103 | 047.07.150 → 53 | 049.04.175 → 49 | 051.20.013 → 68 | 052.10.004 → 66 | 057.02.002 → 159 |
| 042.04.040 → 103 | 047.07.185 → 53 | 049.05.060 → 64 | 051.20.014 → 68 | 052.10.005 → 66 | 057.02.101 → 42 |
| 042.04.060 → 103 | 047.07.210 → 53 | 049.05.100 → 64 | 051.20.015 → 68 | 052.10.006 → 66 | 057.03.200 → 158 |
| 042.04.080 → 103 | 047.07.250 → 53 | 049.05.150 → 64 | 051.20.016 → 68 | 052.10.007 → 66 | 057.03.250 → 158 |
| 042.04.100 → 103 | 047.07.300 → 53 | 049.05.300 → 64 | 051.20.017 → 68 | 052.10.008 → 66 | 057.03.300 → 158 |
| 042.05.001 → 103 | 047.08.150 → 53 | 049.05.900 → 64 | 051.20.018 → 68 | 052.11.001 → 66 | 057.04.251 → 159 |
| 042.06.001 → 103 | 047.08.180 → 53 | 049.06.004 → 48 | 051.20.019 → 68 | 052.11.002 → 66 | 057.05.020 → 158 |
| 042.06.010 → 103 | 047.08.210 → 53 | 049.06.005 → 48 | 051.20.020 → 68 | 052.11.003 → 66 | 057.05.025 → 158 |
| 043.01.051 → 105 | 047.09.100 → 53 | 049.06.006 → 48 | 051.20.021 → 68 | 052.11.004 → 66 | 057.05.030 → 158 |
| 043.01.052 → 105 | 047.09.130 → 53 | 049.07.004 → 48 | 051.20.022 → 68 | 052.12.001 → 66 | 057.05.035 → 158 |
| 043.01.053 → 105 | 047.09.150 → 53 | 049.07.005 → 48 | 051.21.001 → 69 | 052.12.002 → 66 | 057.05.040 → 158 |
| 043.01.054 → 105 | 047.09.180 → 53 | 049.07.006 → 48 | 051.21.002 → 69 | 052.12.003 → 66 | 057.06.037 → 158 |
| 043.01.071 → 105 | 047.09.210 → 53 | 049.08.070 → 64 | 051.21.003 → 69 | 052.12.004 → 66 | 058.01.001 → 70 |
| 043.01.072 → 105 | 047.10.075 → 53 | 049.08.085 → 64 | 051.21.004 → 69 | 052.12.005 → 66 | 058.01.002 → 70 |
| 043.01.073 → 105 | 047.10.100 → 53 | 049.08.110 → 64 | 051.21.005 → 69 | 052.12.006 → 66 | 058.02.001B → 71 |
| 043.01.074 → 105 | 047.10.150 → 53 | 049.09.180 → 48 | 051.21.006 → 69 | 052.12.007 → 66 | 058.02.001P → 71 |

product index

| catalogue no // page | catalogue no // page | catalogue no // page | catalogue no // page | catalogue no // page | catalogue no // page |
|----------------------|----------------------|----------------------|----------------------|----------------------|----------------------|
| 058.02.001R → 71 | 061.10.901 → 33 | 061.29.901 → 37 | 062.51.500 → 39 | 064.12.005 → 82 | 065.44.004 → 84 |
| 058.02.002 → 72 | 061.11.050 → 33 | 061.41.500 → 34 | 062.51.501 → 39 | 064.12.006 → 82 | 065.44.005 → 84 |
| 058.02.101 → 71 | 061.11.100 → 33 | 061.41.901 → 34 | 062.51.502 → 39 | 064.12.007 → 82 | 065.45.001 → 85 |
| 058.03.001 → 70 | 061.11.250 → 33 | 061.41.902 → 34 | 062.52.500 → 39 | 064.12.008 → 82 | 065.45.002 → 85 |
| 058.04.001 → 72 | 061.11.500 → 33 | 061.41.905 → 34 | 062.53.500 → 39 | 064.12.009 → 82 | 065.45.005 → 85 |
| 058.05.080 → 72 | 061.11.901 → 33 | 061.42.125 → 35 | 062.54.500 → 39 | 064.12.010 → 82 | 065.46.001 → 85 |
| 058.05.100 → 72 | 061.13.001 → 37 | 061.42.250 → 35 | 062.55.500 → 39 | 064.12.011 → 82 | 065.46.002 → 85 |
| 058.05.125 → 72 | 061.13.002 → 37 | 061.42.500 → 35 | 062.56.500 → 39 | 064.12.012 → 82 | 065.46.005 → 85 |
| 058.05.150 → 72 | 061.13.004 → 37 | 061.42.901 → 35 | 062.57.500 → 39 | 065.10.001 → 194 | 065.46.006 → 85 |
| 058.06.001 → 91 | 061.13.006 → 37 | 061.42.902 → 35 | 062.58.500 → 39 | 065.10.004 → 194 | 065.47.001 → 85 |
| 058.07.001 → 74 | 061.13.008 → 37 | 061.42.911 → 35 | 062.60.901 → 123 | 065.10.006 → 194 | 065.47.003 → 85 |
| 059.02.001 → 138 | 061.14.025 → 33 | 061.46.901 → 34 | 062.60.902 → 123 | 065.18.001 → 84 | 065.48.001 → 85 |
| 059.02.002 → 138 | 061.14.060 → 33 | 061.46.902 → 34 | 062.60.903 → 123 | 065.18.002 → 84 | 065.48.005 → 85 |
| 059.02.003 → 138 | 061.14.120 → 33 | 061.47.050 → 34 | 062.60.905 → 123 | 065.18.003 → 84 | 065.52.014 → 86 |
| 059.02.004 → 138 | 061.14.300 → 33 | 061.47.125 → 34 | 062.60.909 → 123 | 065.18.004 → 84 | 065.52.029 → 86 |
| 059.03.003 → 141 | 061.14.600 → 33 | 061.47.250 → 34 | 062.60.918 → 123 | 065.19.141 → 82 | 065.53.014 → 86 |
| 059.03.004 → 141 | 061.14.901 → 33 | 061.47.500 → 34 | 062.61.909 → 123 | 065.19.142 → 82 | 065.53.029 → 86 |
| 059.05.001 → 138 | 061.14.906 → 33 | 061.47.901 → 34 | 062.61.914 → 123 | 065.19.291 → 82 | 065.54.014 → 86 |
| 060.01.001 → 139 | 061.14.912 → 33 | 062.02.100 → 41 | 062.66.001 → 42 | 065.19.292 → 82 | 065.54.029 → 86 |
| 060.01.002 → 139 | 061.14.931 → 33 | 062.03.100 → 41 | 062.66.004 → 42 | 065.19.293 → 82 | 065.55.001 → 86 |
| 060.01.003 → 140 | 061.15.100 → 31 | 062.04.100 → 41 | 062.66.500 → 42 | 065.21.014 → 82 | 065.55.002 → 86 |
| 060.02.001 → 140 | 061.15.250 → 31 | 062.04.101 → 41 | 062.66.901 → 42 | 065.21.029 → 82 | 065.55.003 → 86 |
| 060.03.001 → 140 | 061.15.500 → 31 | 062.05.05B → 38 | 062.66.902 → 42 | 065.22.014 → 83 | 065.55.004 → 86 |
| 060.03.002 → 139 | 061.15.901 → 31 | 062.05.05G → 38 | 062.80.901 → 123 | 065.22.029 → 83 | 065.56.001 → 86 |
| 060.04.001 → 51 | 061.15.902 → 31 | 062.05.05R → 38 | 062.80.903 → 123 | 065.23.014 → 83 | 065.56.002 → 86 |
| 061.01.100 → 30 | 061.16.100 → 31 | 062.05.05Y → 38 | 062.80.905 → 123 | 065.23.029 → 83 | 065.56.003 → 86 |
| 061.01.100C → 30 | 061.16.250 → 31 | 062.05.100 → 38 | 062.80.912 → 123 | 065.24.014 → 83 | 065.56.004 → 86 |
| 061.01.250 → 30 | 061.16.500 → 31 | 062.05.250 → 38 | 062.80.925 → 123 | 065.24.029 → 83 | 065.57.001 → 87 |
| 061.01.250C → 30 | 061.16.901 → 31 | 062.05.500 → 38 | 063.01.010 → 82 | 065.25.014 → 83 | 065.57.002 → 87 |
| 061.01.500 → 30 | 061.16.902 → 31 | 062.05.901 → 38 | 063.01.012 → 82 | 065.25.029 → 83 | 065.57.003 → 87 |
| 061.01.500C → 30 | 061.17.100 → 31 | 062.08.250 → 38 | 063.01.014 → 82 | 065.26.014 → 83 | 065.57.004 → 87 |
| 061.01.901 → 30 | 061.17.250 → 31 | 062.08.500 → 38 | 063.01.019 → 82 | 065.26.029 → 83 | 065.58.001 → 87 |
| 061.01.901C → 30 | 061.17.500 → 31 | 062.09.05B → 39 | 063.01.024 → 82 | 065.27.014 → 83 | 065.58.002 → 87 |
| 061.01.902 → 30 | 061.17.901 → 31 | 062.09.05G → 39 | 063.01.029 → 82 | 065.27.029 → 83 | 065.58.003 → 87 |
| 061.01.902C → 30 | 061.17.902 → 31 | 062.09.05R → 39 | 063.01.034 → 82 | 065.28.014 → 83 | 065.58.004 → 87 |
| 061.01.903 → 30 | 061.18.100 → 31 | 062.09.05Y → 39 | 063.01.045 → 82 | 065.28.029 → 83 | 065.60.100 → 89 |
| 061.01.905 → 30 | 061.18.250 → 31 | 062.10.010 → 41 | 063.02.010 → 82 | 065.29.014 → 83 | 065.60.150 → 89 |
| 061.01.910 → 30 | 061.18.500 → 31 | 062.10.015 → 41 | 063.02.012 → 82 | 065.29.029 → 83 | 065.62.100 → 89 |
| 061.01.920 → 30 | 061.18.901 → 31 | 062.10.020 → 41 | 063.02.014 → 82 | 065.30.014 → 88 | 065.62.130 → 89 |
| 061.02.100 → 30 | 061.18.902 → 31 | 062.10.030 → 41 | 063.02.019 → 82 | 065.30.029 → 88 | 065.62.180 → 89 |
| 061.02.100C → 30 | 061.20.001 → 32 | 062.11.250 → 38 | 063.02.024 → 82 | 065.31.014 → 88 | 065.63.100 → 89 |
| 061.02.250 → 30 | 061.21.125 → 36 | 062.11.500 → 38 | 063.02.029 → 82 | 065.31.029 → 88 | 065.63.130 → 89 |
| 061.02.250C → 30 | 061.21.250 → 36 | 062.12.050 → 41 | 063.02.034 → 82 | 065.32.014 → 88 | 065.63.180 → 89 |
| 061.02.500 → 30 | 061.21.500 → 36 | 062.12.100 → 41 | 063.02.045 → 82 | 065.32.029 → 88 | 065.66.125 → 89 |
| 061.02.500C → 30 | 061.21.901 → 36 | 062.13.050 → 41 | 063.04.010 → 91 | 065.33.014 → 88 | 065.66.250 → 89 |
| 061.02.901 → 30 | 061.22.125 → 36 | 062.13.100 → 41 | 063.04.012 → 91 | 065.33.029 → 88 | 065.66.500 → 89 |
| 061.02.901C → 30 | 061.22.250 → 36 | 062.21.902 → 40 | 063.04.014 → 91 | 065.34.014 → 85 | 065.66.901 → 89 |
| 061.02.902 → 30 | 061.22.500 → 36 | 062.21.903 → 40 | 063.04.019 → 91 | 065.34.029 → 85 | 065.67.001 → 89 |
| 061.02.902C → 30 | 061.22.901 → 36 | 062.21.905 → 40 | 063.04.024 → 91 | 065.36.014 → 87 | 065.67.002 → 89 |
| 061.02.903 → 30 | 061.23.125 → 36 | 062.21.910 → 40 | 063.04.029 → 91 | 065.36.019 → 87 | 065.67.011 → 89 |
| 061.02.905 → 30 | 061.23.250 → 36 | 062.21.920 → 40 | 063.04.034 → 91 | 065.36.024 → 87 | 065.67.022 → 89 |
| 061.02.910 → 30 | 061.23.500 → 36 | 062.21.930 → 40 | 063.04.045 → 91 | 065.36.029 → 87 | 065.70.001 → 90 |
| 061.02.920 → 30 | 061.23.901 → 36 | 062.27.905 → 40 | 063.05.001 → 98 | 065.37.014 → 84 | 065.71.001 → 90 |
| 061.07.050 → 32 | 061.24.125 → 36 | 062.27.910 → 40 | 063.14.014 → 91 | 065.37.029 → 84 | 066.10.001 → 94 |
| 061.07.100 → 32 | 061.24.250 → 36 | 062.27.920 → 40 | 063.14.019 → 91 | 065.38.014 → 84 | 066.10.003 → 94 |
| 061.07.250 → 32 | 061.24.500 → 36 | 062.28.905 → 40 | 063.14.024 → 91 | 065.38.029 → 84 | 066.10.004 → 94 |
| 061.07.500 → 32 | 061.24.901 → 36 | 062.28.910 → 40 | 063.14.029 → 91 | 065.39.014 → 88 | 066.11.001 → 94 |
| 061.07.901 → 32 | 061.25.125 → 36 | 062.28.920 → 40 | 063.14.034 → 91 | 065.39.029 → 88 | 066.11.002 → 94 |
| 061.07.902 → 32 | 061.25.250 → 36 | 062.30.002 → 78 | 063.14.045 → 91 | 065.40.014 → 88 | 066.11.003 → 94 |
| 061.08.050 → 32 | 061.25.500 → 36 | 062.36.910 → 43 | 063.17.001 → 91 | 065.40.029 → 88 | 066.11.004 → 94 |
| 061.08.100 → 32 | 061.25.901 → 36 | 062.36.920 → 43 | 063.17.002 → 91 | 065.41.014 → 85 | 066.11.005 → 94 |
| 061.08.250 → 32 | 061.26.125 → 36 | 062.36.930 → 43 | 064.11.001 → 82 | 065.41.019 → 85 | 067.30.001 → 90 |
| 061.08.500 → 32 | 061.26.250 → 36 | 062.39.900 → 43 | 064.11.002 → 82 | 065.41.024 → 85 | 069.03.005 → 126 |
| 061.08.901 → 32 | 061.26.500 → 36 | 062.39.901 → 43 | 064.11.003 → 82 | 065.41.029 → 85 | 069.03.175 → 129 |
| 061.08.902 → 32 | 061.26.901 → 36 | 062.39.902 → 43 | 064.11.004 → 82 | 065.42.001 → 84 | 069.03.660 → 128 |
| 061.09.0B1 → 32 | 061.27.125 → 36 | 062.39.903 → 43 | 064.11.005 → 82 | 065.42.002 → 84 | 069.04.001 → 126 |
| 061.09.0G1 → 32 | 061.27.250 → 36 | 062.39.905 → 43 | 064.11.006 → 82 | 065.42.003 → 84 | 069.04.002 → 126 |
| 061.09.0R1 → 32 | 061.27.500 → 36 | 062.39.907 → 43 | 064.11.007 → 82 | 065.42.004 → 84 | 069.04.175 → 129 |
| 061.09.0Y1 → 32 | 061.27.901 → 36 | 062.39.910 → 43 | 064.11.008 → 82 | 065.43.001 → 84 | 069.04.660 → 128 |
| 061.09.125 → 35 | 061.28.125 → 36 | 062.39.913 → 43 | 064.11.009 → 82 | 065.43.002 → 84 | 069.05.001 → 129 |
| 061.09.250 → 35 | 061.28.250 → 36 | 062.40.901 → 123 | 064.11.010 → 82 | 065.43.003 → 84 | 069.05.175 → 129 |
| 061.09.500 → 35 | 061.28.500 → 36 | 062.40.902 → 123 | 064.11.011 → 82 | 065.43.004 → 84 | 069.05.660 → 128 |
| 061.09.901 → 35 | 061.28.901 → 36 | 062.40.905 → 123 | 064.11.012 → 82 | 065.43.005 → 84 | 071.01.002 → 118 |
| 061.10.050 → 33 | 061.29.040 → 37 | 062.42.910 → 123 | 064.12.001 → 82 | 065.43.006 → 84 | 071.01.003 → 118 |
| 061.10.100 → 33 | 061.29.105 → 37 | 062.42.915 → 123 | 064.12.002 → 82 | 065.44.001 → 84 | 071.01.004 → 118 |
| 061.10.250 → 33 | 061.29.370 → 37 | 062.42.920 → 123 | 064.12.003 → 82 | 065.44.002 → 84 | 071.01.101 → 118 |
| 061.10.500 → 33 | 061.29.720 → 37 | 062.50.500 → 39 | 064.12.004 → 82 | 065.44.003 → 84 | 071.01.102 → 118 |

| catalogue no // page | catalogue no // page | catalogue no // page | catalogue no // page | catalogue no // page | catalogue no // page |
|----------------------|----------------------|----------------------|----------------------|----------------------|----------------------|
| 071.02.001 → 116 | 076.02.001P → 200 | 078.12.009 → 181 | 080.01.006P → 186 | 080.67.001 → 122 | 094.01.001 → 166 |
| 071.02.002 → 116 | 076.02.001R → 200 | 078.20.015W → 182 | 080.01.006R → 186 | 080.76.001 → 135 | 094.01.002 → 166 |
| 071.02.003 → 116 | 076.02.001W → 200 | 078.20.050W → 182 | 080.01.007B → 186 | 081.01.060 → 202 | 094.01.003 → 166 |
| 071.02.004 → 116 | 076.02.002B → 200 | 079.01.001B → 46 | 080.01.007P → 186 | 081.01.080 → 202 | 094.01.005 → 166 |
| 071.02.005 → 116 | 076.02.002O → 200 | 079.01.001O → 46 | 080.01.007R → 186 | 081.01.100 → 202 | 094.01.006 → 166 |
| 071.02.006 → 116 | 076.02.002P → 200 | 079.01.001R → 46 | 080.01.101 → 186 | 081.01.120 → 202 | 094.01.007 → 166 |
| 071.03.001 → 116 | 076.02.002R → 200 | 079.01.001W → 46 | 080.04.001 → 52 | 081.01.150 → 202 | 094.01.008 → 166 |
| 071.05.001 → 117 | 076.02.002W → 200 | 079.01.002B → 46 | 080.04.002 → 52 | 081.02.061 → 202 | 094.01.009 → 166 |
| 071.05.002 → 117 | 076.02.012B → 200 | 079.01.002O → 46 | 080.05.001 → 133 | 081.02.091 → 202 | 094.02.001 → 166 |
| 071.05.003 → 117 | 076.02.012O → 200 | 079.01.002R → 46 | 080.05.002 → 133 | 081.02.092 → 202 | 094.02.002 → 166 |
| 071.05.004 → 117 | 076.02.012P → 200 | 079.01.002W → 46 | 080.06.002B → 187 | 081.02.093 → 202 | 094.02.003 → 166 |
| 071.05.005 → 117 | 076.02.012R → 200 | 079.01.003B → 46 | 080.06.002P → 187 | 081.02.094 → 202 | 094.02.004 → 166 |
| 071.06.001 → 122 | 076.02.012W → 200 | 079.01.003O → 46 | 080.06.002R → 187 | 081.02.121 → 202 | 094.02.005 → 166 |
| 071.06.002 → 122 | 076.02.101 → 200 | 079.01.003R → 46 | 080.10.101 → 131 | 081.02.161 → 202 | 094.02.006 → 166 |
| 071.07.003 → 122 | 076.05.001 → 201 | 079.01.003W → 46 | 080.10.201 → 131 | 081.02.191 → 202 | 094.02.007 → 166 |
| 073.01.001 → 208 | 076.05.002 → 201 | 079.01.004B → 46 | 080.11.001 → 131 | 081.02.192 → 202 | 094.02.008 → 166 |
| 073.03.001 → 208 | 076.05.003 → 201 | 079.01.004O → 46 | 080.13.001 → 131 | 081.02.193 → 202 | 094.03.001 → 166 |
| 073.05.001 → 208 | 076.05.004 → 201 | 079.01.004R → 46 | 080.15.001 → 130 | 081.02.194 → 202 | 094.03.002 → 166 |
| 073.06.001 → 208 | 077.01.000 → 44 | 079.01.004W → 46 | 080.15.002 → 130 | 081.02.221 → 202 | 094.03.003 → 166 |
| 074.01.001 → 209 | 077.01.001 → 44 | 079.01.005B → 46 | 080.15.003 → 130 | 081.04.060 → 202 | 094.03.005 → 166 |
| 074.01.002 → 209 | 077.01.002 → 44 | 079.01.005O → 46 | 080.15.004 → 130 | 081.04.160 → 202 | 094.03.006 → 166 |
| 074.01.003 → 209 | 077.01.003 → 44 | 079.01.005R → 46 | 080.16.001 → 130 | 081.10.001 → 204 | 094.03.007 → 166 |
| 074.01.004 → 209 | 077.01.004 → 44 | 079.01.005W → 46 | 080.16.002 → 130 | 081.13.060 → 203 | 094.03.008 → 166 |
| 074.01.005 → 209 | 077.01.005 → 44 | 079.01.006B → 46 | 080.16.003 → 130 | 081.13.090 → 203 | 094.03.009 → 166 |
| 074.02.001 → 209 | 077.01.006 → 44 | 079.01.006O → 46 | 080.16.004 → 130 | 081.14.001 → 198 | 094.04.001 → 166 |
| 074.03.001 → 209 | 077.01.007 → 44 | 079.01.006R → 46 | 080.17.001 → 133 | 081.14.002 → 198 | 094.04.002 → 166 |
| 074.03.002 → 209 | 077.01.008 → 44 | 079.01.006W → 46 | 080.17.002 → 133 | 081.20.001 → 203 | 094.04.003 → 166 |
| 074.03.003 → 209 | 077.01.021 → 44 | 079.01.101 → 45 | 080.18.001 → 133 | 082.01.001 → 204 | 094.04.004 → 166 |
| 074.03.004 → 209 | 077.01.031 → 44 | 079.01.102 → 45 | 080.18.002 → 133 | 082.01.002 → 204 | 094.04.005 → 166 |
| 074.03.005 → 209 | 077.02.001 → 44 | 079.01.103 → 45 | 080.21.007 → 132 | 082.01.003 → 204 | 094.04.006 → 166 |
| 074.04.001 → 209 | 077.02.002 → 44 | 079.01.104 → 45 | 080.21.008 → 132 | 082.02.001 → 205 | 094.04.007 → 166 |
| 074.04.002 → 209 | 077.02.003 → 44 | 079.01.105 → 45 | 080.21.009 → 132 | 082.02.003 → 205 | 094.04.008 → 166 |
| 074.04.003 → 209 | 077.02.004 → 44 | 079.01.106 → 45 | 080.22.007 → 132 | 082.03.001 → 205 | 094.05.001 → 166 |
| 074.04.004 → 209 | 077.02.005 → 44 | 079.02.001 → 45 | 080.22.008 → 132 | 082.03.003 → 205 | 094.05.002 → 166 |
| 074.04.005 → 209 | 077.02.006 → 44 | 079.02.002 → 45 | 080.22.009 → 132 | 083.13.001 → 13 | 094.05.003 → 166 |
| 074.07.001 → 208 | 077.03.001 → 44 | 079.02.003 → 45 | 080.23.007 → 132 | 083.13.002 → 13 | 094.05.005 → 166 |
| 074.07.002 → 208 | 077.03.002 → 44 | 079.03.001B → 47 | 080.23.008 → 132 | 083.13.005 → 13 | 094.05.006 → 166 |
| 074.07.003 → 208 | 077.04.001 → 44 | 079.03.001O → 47 | 080.23.009 → 132 | 083.13.010 → 13 | 094.05.007 → 166 |
| 075.00.001 → 199 | 077.04.002 → 44 | 079.03.001R → 47 | 080.26.007 → 132 | 083.13.025 → 13 | 094.05.008 → 166 |
| 075.00.002 → 199 | 077.04.003 → 44 | 079.03.001W → 47 | 080.26.009 → 132 | 083.13.050 → 13 | 094.05.009 → 166 |
| 075.00.003 → 199 | 077.04.004 → 44 | 079.03.002B → 47 | 080.26.010 → 132 | 083.13.100 → 13 | 094.06.006 → 166 |
| 075.00.004 → 199 | 077.04.005 → 44 | 079.03.002O → 47 | 080.40.001 → 125 | 084.01.001 → 13 | 094.07.001 → 166 |
| 075.00.005 → 199 | 077.04.006 → 44 | 079.03.002R → 47 | 080.40.002B → 124 | 084.01.002 → 13 | 094.07.002 → 166 |
| 075.00.006 → 199 | 078.01.001 → 44 | 079.03.002W → 47 | 080.40.002G → 124 | 084.02.001 → 13 | 094.07.003 → 166 |
| 075.00.007 → 199 | 078.01.002 → 44 | 079.03.003B → 47 | 080.40.002P → 124 | 084.02.003 → 13 | 094.07.005 → 166 |
| 075.01.001 → 199 | 078.02.001 → 180 | 079.03.003O → 47 | 080.40.002R → 124 | 084.03.001 → 13 | 094.07.006 → 166 |
| 075.01.002 → 199 | 078.02.002 → 180 | 079.03.003R → 47 | 080.40.003 → 124 | 084.05.001 → 13 | 094.07.007 → 166 |
| 075.01.003 → 199 | 078.02.003 → 180 | 079.03.003W → 47 | 080.40.004 → 125 | 084.22.001 → 13 | 094.07.008 → 166 |
| 075.01.004 → 199 | 078.02.004 → 180 | 079.03.004B → 47 | 080.40.007 → 124 | 084.22.003 → 13 | 094.07.009 → 166 |
| 075.01.005 → 199 | 078.02.005 → 181 | 079.03.004O → 47 | 080.40.010 → 126 | 087.02.001 → 37 | 094.08.006 → 166 |
| 075.01.006 → 199 | 078.02.006 → 181 | 079.03.004R → 47 | 080.40.011 → 125 | 087.02.002 → 37 | 094.11.005 → 168 |
| 075.01.007 → 199 | 078.02.007 → 180 | 079.03.004W → 47 | 080.40.021 → 125 | 088.01.001 → 210 | 094.11.010 → 168 |
| 075.02.005 → 199 | 078.02.008 → 180 | 079.03.005B → 47 | 080.40.101 → 127 | 088.02.001 → 210 | 094.11.025 → 168 |
| 075.02.006 → 199 | 078.02.009 → 181 | 079.03.005O → 47 | 080.40.102 → 127 | 088.02.002 → 210 | 094.11.050 → 168 |
| 075.02.007 → 199 | 078.03.001 → 184 | 079.03.005R → 47 | 080.41.001 → 136 | 088.02.003 → 210 | 094.11.100 → 168 |
| 075.02.008 → 199 | 078.03.002 → 184 | 079.03.005W → 47 | 080.41.002 → 136 | 088.03.001 → 210 | 094.11.250 → 168 |
| 075.02.009 → 199 | 078.03.003 → 184 | 079.03.006B → 183 | 080.41.003 → 136 | 089.03.012B → 191 | 094.11.500 → 168 |
| 075.03.001 → 198 | 078.03.004 → 184 | 079.04.001 → 183 | 080.44.001 → 136 | 089.03.012P → 191 | 094.12.005 → 168 |
| 075.03.002 → 198 | 078.03.021 → 184 | 079.08.015B → 182 | 080.44.101 → 136 | 089.03.012R → 191 | 094.12.010 → 168 |
| 075.04.001 → 198 | 078.03.022 → 184 | 079.08.015L → 182 | 080.45.001 → 136 | 089.03.013 → 191 | 094.12.025 → 168 |
| 075.05.001 → 199 | 078.03.023 → 184 | 079.08.050B → 182 | 080.45.101 → 136 | 091.11.102 → 185 | 094.12.050 → 168 |
| 075.05.002 → 199 | 078.03.024 → 184 | 079.08.050L → 182 | 080.50.001 → 134 | 091.11.105 → 185 | 094.12.100 → 168 |
| 075.05.003 → 199 | 078.05.002 → 184 | 079.11.016 → 45 | 080.50.011 → 134 | 091.15.001 → 185 | 094.12.250 → 168 |
| 075.05.004 → 199 | 078.05.005 → 184 | 080.01.001 → 46 | 080.51.003 → 134 | 091.15.002 → 185 | 094.12.500 → 168 |
| 076.01.001B → 201 | 078.05.022 → 184 | 080.01.002B → 175 | 080.51.004 → 134 | 091.15.003 → 185 | 094.13.005 → 168 |
| 076.01.001G → 201 | 078.05.025 → 184 | 080.01.002P → 175 | 080.51.005 → 134 | 091.15.004 → 185 | 094.13.010 → 168 |
| 076.01.001R → 201 | 078.05.105 → 184 | 080.01.002R → 175 | 080.51.006 → 134 | 091.15.005 → 185 | 094.13.025 → 168 |
| 076.01.001W → 201 | 078.06.015B → 181 | 080.01.003B → 187 | 080.53.001 → 134 | 092.01.001B → 188 | 094.13.050 → 168 |
| 076.01.001Y → 201 | 078.06.050B → 181 | 080.01.003P → 187 | 080.53.021 → 134 | 092.01.001P → 188 | 094.13.100 → 168 |
| 076.01.003 → 201 | 078.12.001 → 180 | 080.01.003R → 187 | 080.65.002 → 122 | 092.01.001R → 188 | 094.13.250 → 168 |
| 076.02.000B → 200 | 078.12.002 → 180 | 080.01.004B → 186 | 080.65.003 → 127 | 092.22.101W → 189 | 094.13.500 → 168 |
| 076.02.000O → 200 | 078.12.003 → 180 | 080.01.004P → 186 | 080.65.004 → 122 | 092.22.102W → 189 | 094.21.005 → 168 |
| 076.02.000P → 200 | 078.12.004 → 180 | 080.01.004R → 186 | 080.66.001 → 135 | 092.35.003 → 185 | 094.21.010 → 168 |
| 076.02.000R → 200 | 078.12.005 → 181 | 080.01.005B → 186 | 080.66.002 → 135 | 093.01.001G → 189 | 094.21.025 → 168 |
| 076.02.000W → 200 | 078.12.006 → 181 | 080.01.005P → 186 | 080.66.003 → 135 | 093.01.001P → 189 | 094.21.050 → 168 |
| 076.02.001B → 200 | 078.12.007 → 180 | 080.01.005R → 186 | 080.66.005 → 135 | 093.01.001R → 189 | 094.21.100 → 168 |
| 076.02.001O → 200 | 078.12.008 → 180 | 080.01.006B → 186 | 080.66.006 → 135 | 093.01.002B → 189 | 094.21.250 → 168 |

product index

| catalogue no // page | catalogue no // page | catalogue no // page | catalogue no // page | catalogue no // page | catalogue no // page |
|----------------------|----------------------|----------------------|----------------------|----------------------|----------------------|
| 094.21.500 → 168 | 095.02.001 → 172 | 099.05.019 → 76 | 105.03.110 → 108 | 605.01.104 → 101 | 621.11.103 → 161 |
| 094.22.005 → 168 | 095.02.002 → 172 | 099.05.025 → 76 | 105.03.125 → 108 | 605.01.105 → 101 | 621.11.250 → 161 |
| 094.22.010 → 168 | 095.03.001 → 173 | 099.05.109 → 76 | 105.11.110 → 108 | 605.01.106 → 101 | 622.01.001 → 164 |
| 094.22.025 → 168 | 095.03.002 → 173 | 099.05.113 → 76 | 105.11.125 → 108 | 605.01.107 → 101 | 622.02.001 → 164 |
| 094.22.050 → 168 | 095.03.003 → 173 | 099.06.024 → 77 | 105.12.110 → 108 | 605.01.108 → 101 | 622.03.001 → 164 |
| 094.22.100 → 168 | 095.03.004 → 173 | 099.06.033 → 77 | 105.12.125 → 108 | 605.01.109 → 101 | 622.11.001 → 109 |
| 094.22.250 → 168 | 095.03.011 → 174 | 099.06.038 → 77 | 105.13.110 → 108 | 605.01.110 → 101 | 622.12.001 → 109 |
| 094.22.500 → 168 | 095.03.012 → 174 | 099.06.124 → 77 | 105.13.125 → 108 | 605.01.111 → 101 | 623.01.004 → 100 |
| 094.31.005 → 168 | 095.05.001 → 172 | 099.06.133 → 77 | 106.01.110 → 108 | 605.01.112 → 101 | 623.01.008 → 100 |
| 094.31.010 → 168 | 095.05.002 → 172 | 099.07.033 → 77 | 106.01.125 → 108 | 605.01.113 → 101 | 623.02.004 → 100 |
| 094.31.020 → 168 | 095.06.001 → 172 | 099.07.038 → 77 | 106.02.110 → 108 | 605.01.114 → 101 | 623.02.008 → 100 |
| 094.31.050 → 168 | 095.06.002 → 172 | 099.11.001 → 74 | 106.02.125 → 108 | 605.01.115 → 101 | 623.11.110 → 100 |
| 094.31.100 → 168 | 095.06.003 → 172 | 099.11.002 → 74 | 106.03.110 → 108 | 608.01.101 → 80 | 908.B01.1000 → 147 |
| 094.31.250 → 168 | 095.95.001 → 175 | 099.11.003 → 74 | 106.03.125 → 108 | 608.01.102 → 80 | 908.B02.1000 → 147 |
| 094.32.005 → 168 | 095.95.002 → 175 | 099.11.004 → 74 | 106.11.110 → 108 | 608.11.100 → 163 | 908.B03.1000 → 147 |
| 094.32.010 → 168 | 096.00.001 → 171 | 099.12.001 → 74 | 106.11.125 → 108 | 608.11.250 → 163 | 908.B04.1000 → 147 |
| 094.32.020 → 168 | 096.00.002 → 171 | 099.12.002 → 74 | 106.12.110 → 108 | 608.11.500 → 163 | 908.B05.1000 → 147 |
| 094.32.050 → 168 | 096.01.001 → 171 | 099.12.003 → 74 | 106.12.125 → 108 | 608.11.901 → 163 | 908.B06.1000 → 147 |
| 094.32.100 → 168 | 096.01.002 → 171 | 099.12.004 → 74 | 106.13.110 → 108 | 608.11.902 → 163 | 908.B07.1000 → 147 |
| 094.32.250 → 168 | 096.01.004 → 171 | 099.13.001 → 74 | 106.13.125 → 108 | 608.12.100 → 163 | 908.B08.1000 → 147 |
| 094.41.005 → 169 | 096.02.001 → 172 | 099.13.002 → 74 | 107.40.140 → 108 | 608.12.250 → 163 | 908.B09.1000 → 147 |
| 094.41.010 → 169 | 096.02.002 → 172 | 099.13.003 → 74 | 107.58.158 → 108 | 608.12.500 → 163 | 908.B10.1000 → 147 |
| 094.41.025 → 169 | 096.03.001 → 173 | 099.13.004 → 74 | 108.01.001 → 178 | 608.12.901 → 163 | 908.B11.1000 → 147 |
| 094.41.050 → 169 | 096.05.001 → 173 | 099.14.001 → 74 | 108.01.015 → 178 | 610.01.005 → 17 | TF-010 → 22 |
| 094.41.100 → 169 | 096.05.003 → 172 | 099.14.003 → 74 | 108.01.016 → 178 | 610.01.006 → 17 | TF-011 → 22 |
| 094.41.250 → 169 | 096.05.004 → 172 | 099.15.001 → 74 | 108.02.001 → 178 | 613.01.001 → 156 | TF-1000 → 22 |
| 094.41.500 → 169 | 096.05.011 → 174 | 099.15.002 → 74 | 108.02.002 → 178 | 613.01.102 → 156 | TF-1000A → 22 |
| 094.41.901 → 169 | 096.05.012 → 174 | 099.15.003 → 74 | 120.11.025 → 192 | 613.03.001 → 157 | TF-10000A-S → 22 |
| 094.41.902 → 169 | 097.01.011 → 174 | 099.15.004 → 74 | 120.11.075 → 192 | 613.05.001 → 157 | TF-10000B-S → 22 |
| 094.41.905 → 169 | 097.01.020 → 174 | 099.16.002 → 74 | 120.11.175 → 192 | 613.06.001 → 156 | TF-10000B-S → 22 |
| 094.41.910 → 169 | 097.02.011 → 174 | 099.16.004 → 74 | 120.12.025 → 192 | 613.07.001 → 157 | TF-1250 → 22 |
| 094.42.005 → 169 | 097.02.020 → 174 | 099.17.001 → 74 | 120.12.075 → 192 | 613.21.001 → 196 | TF-200 → 22 |
| 094.42.010 → 169 | 097.03.001 → 173 | 099.17.003 → 74 | 120.12.175 → 192 | 613.22.001 → 197 | TF-300 → 22 |
| 094.42.025 → 169 | 097.03.002 → 173 | 099.18.001 → 74 | 120.13.035 → 193 | 613.31.001 → 196 | TF-5000A → 22 |
| 094.42.050 → 169 | 097.04.001 → 173 | 099.18.002 → 74 | 120.13.060 → 193 | 613.41.001 → 197 | TF-5000A-S → 22 |
| 094.42.100 → 169 | 097.04.002 → 173 | 099.18.003 → 74 | 120.13.090 → 193 | 615.01.001 → 160 | TF-5000B → 22 |
| 094.42.250 → 169 | 097.05.106 → 171 | 099.18.004 → 74 | 121.01.001 → 206 | 615.01.012 → 160 | TF-5000B-S → 22 |
| 094.42.500 → 169 | 097.05.107 → 171 | 099.19.001 → 74 | 121.11.023 → 206 | 615.01.101 → 160 | TF-010 → 22 |
| 094.42.901 → 169 | 097.05.108 → 171 | 099.19.003 → 74 | 121.12.030 → 206 | 615.01.103 → 160 | TF-011 → 22 |
| 094.42.902 → 169 | 097.05.109 → 171 | 099.50.001 → 76 | 122.11.006 → 193 | 616.01.001 → 144 | TF-100 → 22 |
| 094.42.905 → 169 | 097.05.110 → 171 | 099.60.001 → 76 | 122.11.012 → 193 | 616.01.101 → 146 | TF-1000 → 22 |
| 094.42.910 → 169 | 097.05.111 → 171 | 101.01.001 → 148 | 122.11.024 → 193 | 616.01.103 → 146 | TF-1250 → 22 |
| 094.51.005 → 169 | 098.01.001 → 176 | 101.01.002 → 148 | 122.11.048 → 193 | 616.01.104 → 146 | TF-200 → 22 |
| 094.51.010 → 169 | 098.01.002 → 176 | 101.02.001 → 148 | 122.11.096 → 193 | 616.02.002 → 144 | TF-300 → 22 |
| 094.51.025 → 169 | 098.01.003 → 176 | 101.02.002 → 148 | 122.11.196 → 193 | 616.02.101 → 146 | TF-50 → 22 |
| 094.51.050 → 169 | 098.01.004 → 176 | 101.02.003 → 148 | 123.01.002 → 190 | 616.02.102 → 146 | TF-R-S-010 → 22 |
| 094.51.100 → 169 | 098.01.005 → 176 | 101.03.001 → 119 | 123.01.028 → 190 | 616.11.001 → 145 | TF-R-S-011 → 22 |
| 094.51.250 → 169 | 098.01.006 → 176 | 101.03.003 → 149 | 123.01.096 → 191 | 616.11.101 → 146 | TF-R-S-021 → 22 |
| 094.51.500 → 169 | 098.01.007 → 177 | 101.03.004 → 149 | 123.02.018 → 190 | 616.11.102 → 146 | TF-R-S-100 → 22 |
| 094.51.901 → 169 | 098.01.008 → 177 | 101.03.005 → 149 | 123.02.028 → 190 | 616.11.103 → 146 | TF-R-S-1000 → 22 |
| 094.51.902 → 169 | 098.01.009 → 177 | 101.04.003 → 148 | 123.02.096 → 191 | 616.11.104 → 146 | TF-R-S-1250 → 22 |
| 094.51.905 → 169 | 098.01.010 → 177 | 101.13.003 → 149 | 123.03.028 → 190 | 616.11.105 → 146 | TF-R-S-200 → 22 |
| 094.51.910 → 169 | 098.01.011 → 177 | 101.13.004 → 149 | 124.01.001 → 191 | 616.11.107 → 146 | TF-R-S-300 → 22 |
| 094.52.005 → 169 | 098.01.012 → 177 | 101.13.005 → 149 | 502.04.500 → 147 | 616.11.108 → 146 | TF-R-S-50 → 22 |
| 094.52.010 → 169 | 098.02.001 → 176 | 101.14.003 → 148 | 502.04.901 → 147 | 616.11.109 → 145 | TR-010 → 22 |
| 094.52.025 → 169 | 098.02.002 → 176 | 102.28.080 → 95 | 502.07.500 → 147 | 616.12.001 → 145 | TR-011 → 22 |
| 094.52.050 → 169 | 098.03.001B → 177 | 102.30.080 → 95 | 502.07.901 → 147 | 618.21.001 → 195 | TR-1000 → 22 |
| 094.52.100 → 169 | 098.03.001P → 177 | 102.33.080 → 95 | 502.10.500 → 147 | 618.22.001 → 195 | TR-1250 → 22 |
| 094.52.250 → 169 | 098.03.001R → 177 | 102.33.094 → 95 | 502.10.901 → 147 | 618.23.001 → 195 | TR-200 → 22 |
| 094.52.500 → 169 | 098.03.002B → 177 | 102.34.120 → 95 | 601.02.024 → 119 | 618.24.001 → 195 | TR-300 → 22 |
| 094.52.901 → 169 | 098.03.002P → 177 | 104.01.001 → 167 | 602.01.001 → 162 | 618.25.001 → 195 | TR-S-010 → 22 |
| 094.52.902 → 169 | 098.03.002R → 177 | 104.01.002 → 167 | 602.01.101 → 162 | 618.32.001 → 195 | TR-S-011 → 22 |
| 094.52.905 → 169 | 099.01.001 → 73 | 104.01.003 → 167 | 602.02.001 → 162 | 618.41.001 → 195 | TR-S-1000 → 22 |
| 094.52.910 → 169 | 099.01.002 → 73 | 104.01.004 → 167 | 602.31.001 → 150 | 621.01.101 → 121 | TR-S-1250 → 22 |
| 094.91.002 → 166 | 099.01.003 → 73 | 104.01.005 → 167 | 602.31.002 → 150 | 621.05.001 → 120 | TR-S-200 → 22 |
| 094.91.005 → 166 | 099.01.006 → 73 | 104.01.006 → 167 | 602.31.003 → 150 | 621.05.003 → 120 | TR-S-300 → 22 |
| 094.91.010 → 166 | 099.02.001 → 75 | 104.01.007 → 167 | 602.31.006 → 151 | 621.05.006 → 120 | |
| 094.91.020 → 166 | 099.02.002 → 75 | 104.01.008 → 167 | 602.31.007 → 151 | 621.05.010 → 120 | |
| 094.92.001 → 169 | 099.02.011 → 75 | 104.01.009 → 167 | 602.32.001 → 151 | 621.05.015 → 120 | |
| 094.92.005 → 169 | 099.03.050 → 75 | 104.01.010 → 167 | 603.01.001 → 112 | 621.05.022 → 120 | |
| 094.92.010 → 169 | 099.03.072 → 75 | 104.01.011 → 167 | 603.02.001 → 113 | 621.05.028 → 120 | |
| 094.92.020 → 169 | 099.03.090 → 75 | 104.01.012 → 167 | 603.05.001 → 114 | 621.06.003 → 121 | |
| 094.92.050 → 169 | 099.04.001 → 74 | 104.01.013 → 167 | 603.11.001 → 203 | 621.06.006 → 121 | |
| 095.00.001 → 171 | 099.04.004 → 74 | 105.01.110 → 108 | 605.01.001 → 101 | 621.06.010 → 121 | |
| 095.00.002 → 171 | 099.04.005 → 74 | 105.01.125 → 108 | 605.01.101 → 101 | 621.08.001 → 127 | |
| 095.01.001 → 171 | 099.05.009 → 76 | 105.02.110 → 108 | 605.01.102 → 101 | 621.11.001 → 161 | |
| 095.01.002 → 171 | 099.05.013 → 76 | 105.02.125 → 108 | 605.01.103 → 101 | 621.11.050 → 161 | |



ISOLAB

Laborgeräte GmbH

ISOLAB
Laborgeräte GmbH

Am Dillhof 2 - 63863 Eschau - GERMANY
Phone: +49 93 74 / 978 55 - 0 Fax: +49 93 74 / 978 55 - 85
info@isolab.de

www.isolab.de